

ISOMETRIC VIEW

SIDE VIEW

40'x100' JUMBOTRAC GABLE FRAME TENT

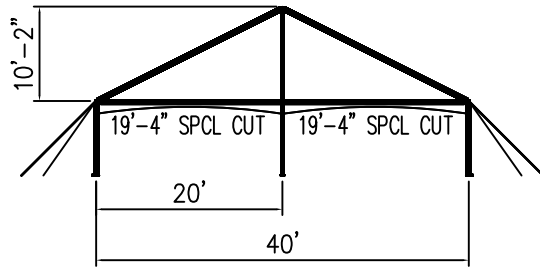

VIEW A-A

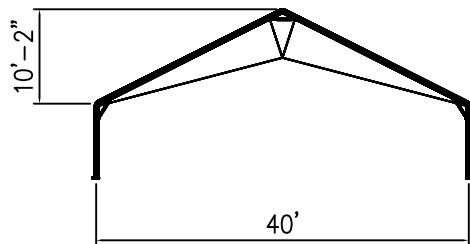

SECTION B-B

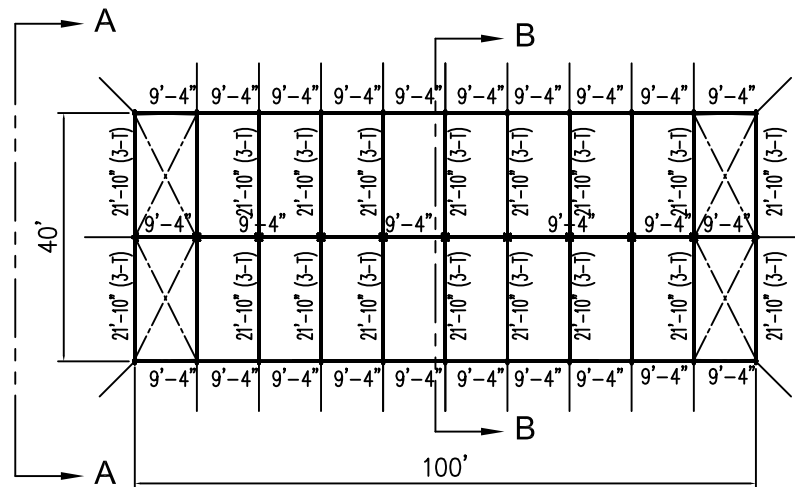

PLAN VIEW

ALL DATA AND INFORMATION CONTAINED IN OR DISCLOSED BY THIS DOCUMENT IS CONFIDENTIAL AND PROPRIETARY INFORMATION OF AZTEC TENTS AND ALL RIGHTS THEREIN ARE EXPRESSLY RESERVED. BY ACCEPTING THIS MATERIAL THE RECIPIENT AGREES THAT THIS MATERIAL AND INFORMATION CONTAINED THEREIN IS HELD IN CONFIDENCE AND IN TRUST AND WILL NOT BE COPIED, REPRODUCED WHOLE OR IN PART, NOR ITS CONTENTS REVEALED IN ANY MANNER TO OTHERS, EXCEPT TO MEET THE SPECIFIC PURPOSE FOR WHICH IT WAS DELIVERED.

AZTEC TENTS
 DESIGN & PRODUCTION
 2665 COLUMBIA ST. TORRANCE, CA. 90503
 (800) 228-3687 - FAX (310) 381-0722

GABLE FRAME
 CENTER CLEAR STRUCTURE/STANDARD
 40' W X 100'
 PART NUMBER: ZXXXXXX

| REVISION HISTORY | | | |
|------------------|-------------|-----|-------|
| REV. | DESCRIPTION | BY: | DATE: |
| N/A | N/A | N/A | N/A |
| N/A | N/A | N/A | N/A |
| N/A | N/A | N/A | N/A |
| N/A | N/A | N/A | N/A |
| N/A | N/A | N/A | N/A |

CONFIDENTIAL

ENGINEER: N/A DATE: 8/11/2016
 PAGE: 1 OF 1 DRAWN: HUGO.R

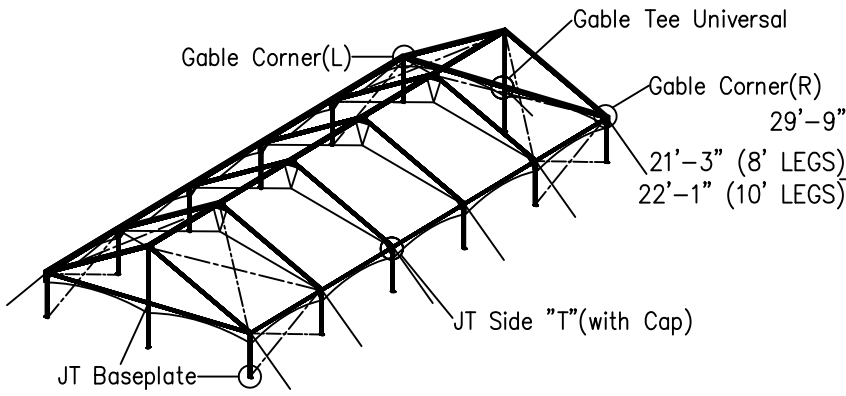

ISOMETRIC VIEW

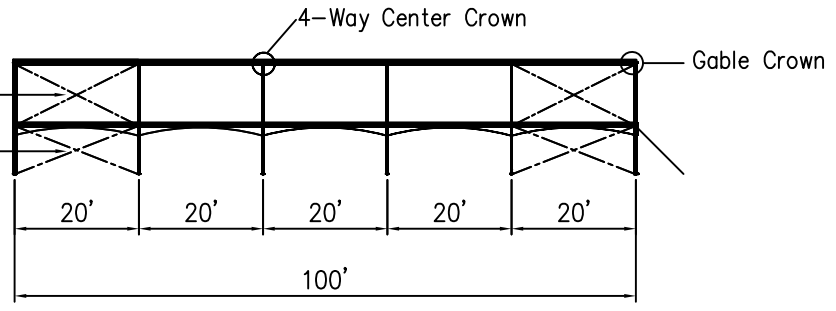

SIDE VIEW

40'x100' JUMBOTRAC GABLE FRAME TENT

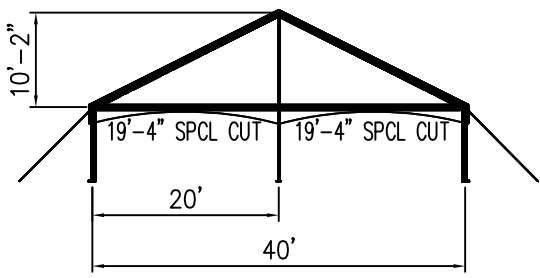

VIEW A-A

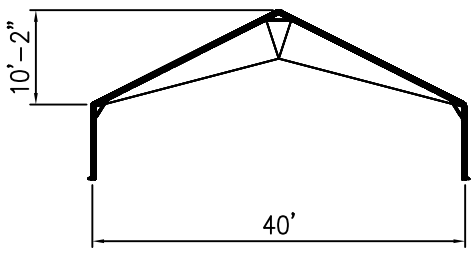

VIEW B-B

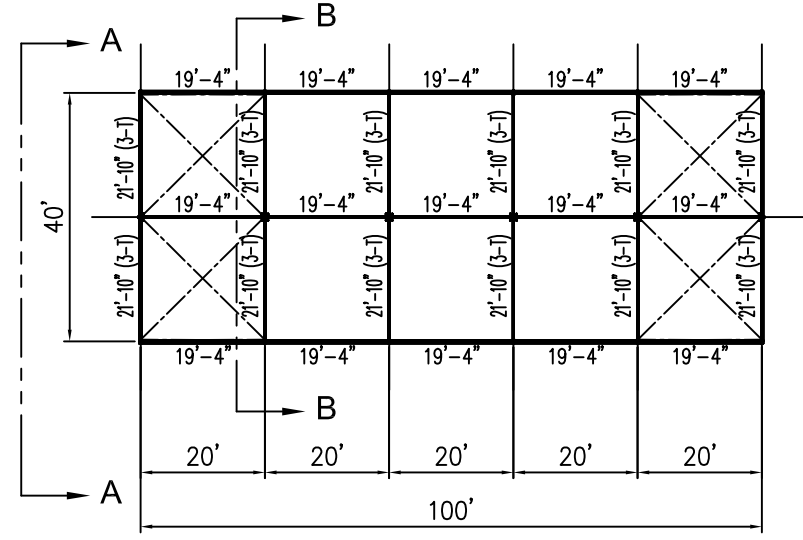

PLAN VIEW

ALL DATA AND INFORMATION CONTAINED IN OR DISCLOSED BY THIS DOCUMENT IS CONFIDENTIAL AND PROPRIETARY INFORMATION OF AZTEC TENTS AND ALL RIGHTS THEREIN ARE EXPRESSLY RESERVED. BY ACCEPTING THIS MATERIAL THE RECIPIENT AGREES THAT THIS MATERIAL AND INFORMATION CONTAINED THEREIN IS HELD IN CONFIDENCE AND IN TRUST AND WILL NOT BE COPIED, REPRODUCED WHOLE OR IN PART, NOR ITS CONTENTS REVEALED IN ANY MANNER TO OTHERS, EXCEPT TO MEET THE SPECIFIC PURPOSE FOR WHICH IT WAS DELIVERED.

AZTEC TENTS
 DESIGN & PRODUCTION
 2665 COLUMBIA ST. TORRANCE, CA. 90503
 (800) 228-3687 - FAX (310) 381-0722

GABLE FRAME
 CENTER CLEAR STRUCTURE/STANDARD
 40'W X 100'L
 PART NUMBER: ZXXXXXX

| REVISION HISTORY | | | |
|------------------|-------------|-----|-------|
| REV. | DESCRIPTION | BY: | DATE: |
| | | | |
| | | | |
| | | | |

CONFIDENTIAL

| | | | |
|-----------|--------|--------|-----------|
| ENGINEER: | N/A | DATE: | 8/16/2016 |
| PAGE: | 1 OF 1 | DRAWN: | HUGO.R |

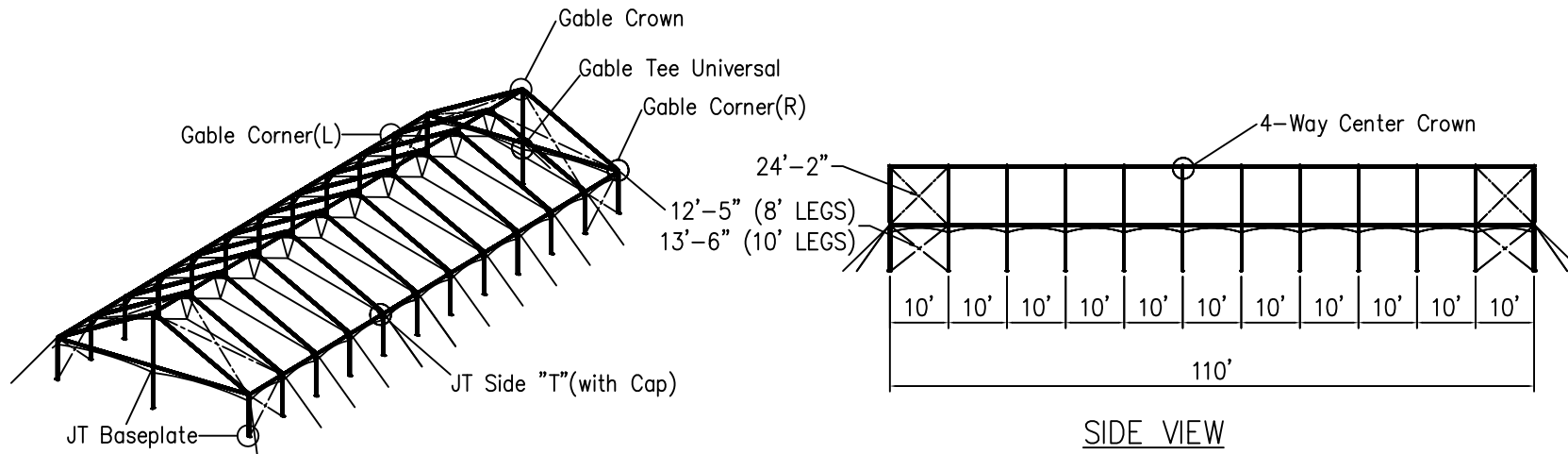

ISOMETRIC VIEW

SIDE VIEW

40'x110' JUMBOTRAC GABLE FRAME TENT

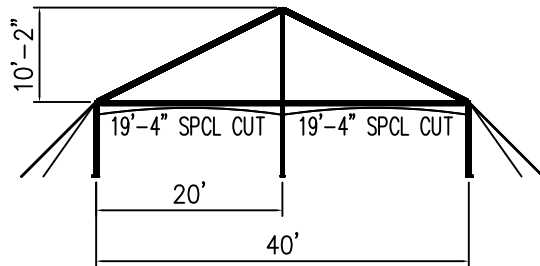

VIEW A-A

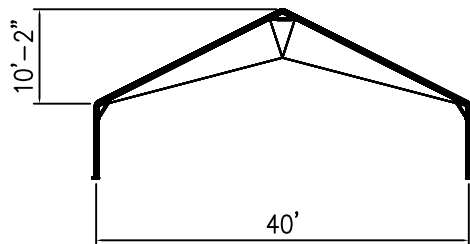

SECTION B-B

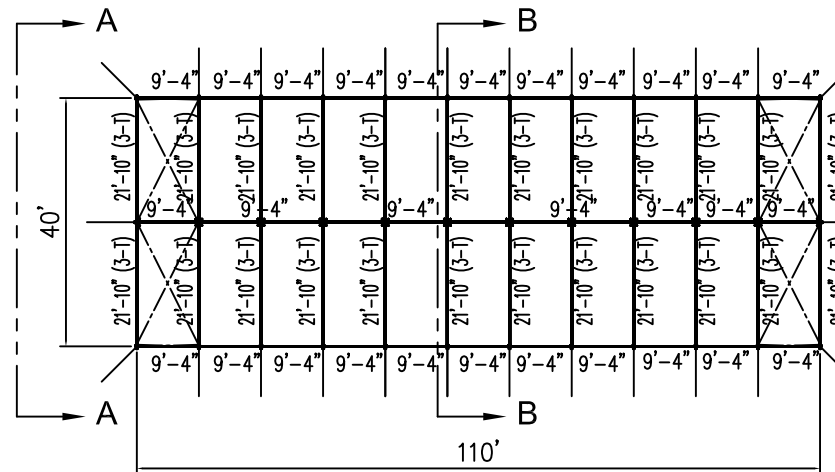

PLAN VIEW

ALL DATA AND INFORMATION CONTAINED IN OR DISCLOSED BY THIS DOCUMENT IS CONFIDENTIAL AND PROPRIETARY INFORMATION OF AZTEC TENTS AND ALL RIGHTS THEREIN ARE EXPRESSLY RESERVED. BY ACCEPTING THIS MATERIAL THE RECIPIENT AGREES THAT THIS MATERIAL AND INFORMATION CONTAINED THEREIN IS HELD IN CONFIDENCE AND IN TRUST AND WILL NOT BE COPIED, REPRODUCED WHOLE OR IN PART, NOR ITS CONTENTS REVEALED IN ANY MANNER TO OTHERS, EXCEPT TO MEET THE SPECIFIC PURPOSE FOR WHICH IT WAS DELIVERED.

AZTEC TENTS
 DESIGN & PRODUCTION
 2665 COLUMBIA ST. TORRANCE, CA. 90503
 (800) 228-3687 - FAX (310) 381-0722

GABLE FRAME
 CENTER CLEAR STRUCTURE/STANDARD
 40' W X 110' L
 PART NUMBER: ZXXXXXX

| REVISION HISTORY | | | |
|------------------|-------------|-----|-------|
| REV. | DESCRIPTION | BY: | DATE: |
| N/A | N/A | N/A | N/A |
| N/A | N/A | N/A | N/A |
| N/A | N/A | N/A | N/A |
| N/A | N/A | N/A | N/A |
| N/A | N/A | N/A | N/A |

CONFIDENTIAL

ENGINEER: N/A DATE: 8/11/2016
 PAGE: 1 OF 1 DRAWN: HUGO.R

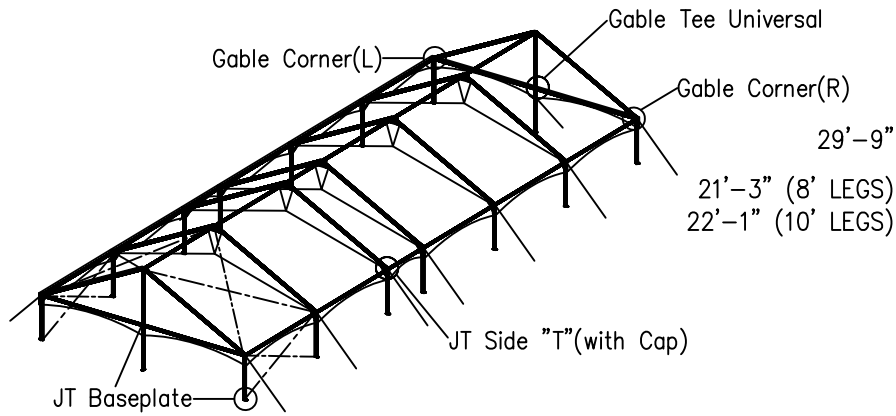

ISOMETRIC VIEW

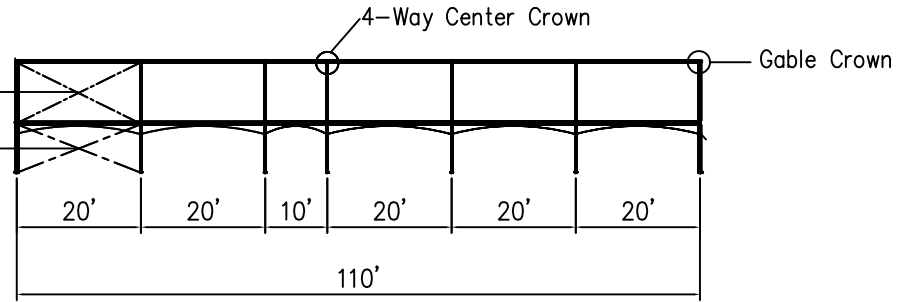

SIDE VIEW

40'x110' JUMBOTRAC GABLE FRAME TENT

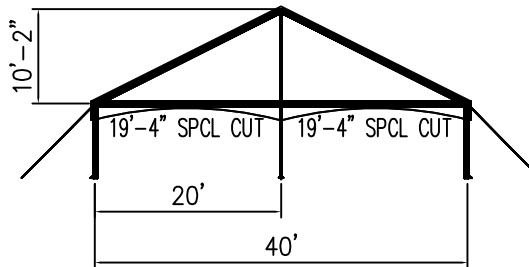

VIEW A-A

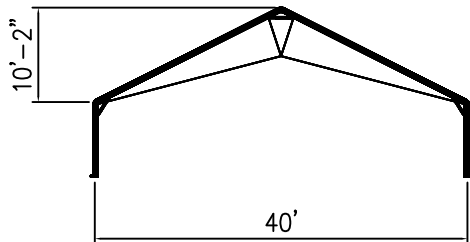

VIEW B-B

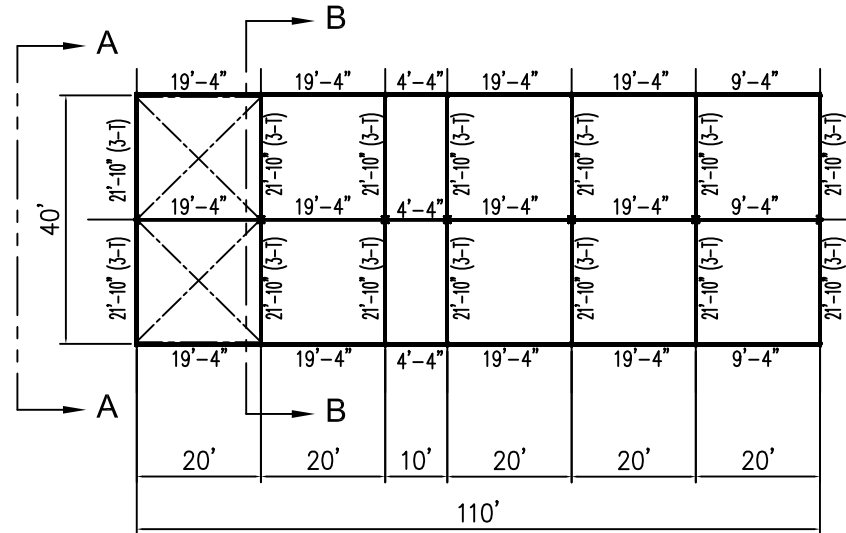

PLAN VIEW

ALL DATA AND INFORMATION CONTAINED IN OR DISCLOSED BY THIS DOCUMENT IS CONFIDENTIAL AND PROPRIETARY INFORMATION OF AZTEC TENTS AND ALL RIGHTS THEREIN ARE EXPRESSLY RESERVED. BY ACCEPTING THIS MATERIAL THE RECIPIENT AGREES THAT THIS MATERIAL AND INFORMATION CONTAINED THEREIN IS HELD IN CONFIDENCE AND IN TRUST AND WILL NOT BE COPIED, REPRODUCED WHOLE OR IN PART, NOR ITS CONTENTS REVEALED IN ANY MANNER TO OTHERS, EXCEPT TO MEET THE SPECIFIC PURPOSE FOR WHICH IT WAS DELIVERED.

AZTEC TENTS
 DESIGN & PRODUCTION
 2665 COLUMBIA ST. TORRANCE, CA. 90503
 (800) 228-3687 - FAX (310) 381-0722

GABLE FRAME
 CENTER CLEAR STRUCTURE/STANDARD
 40'W X 110'L
 PART NUMBER: ZXXXXXX

| REVISION HISTORY | | | |
|------------------|-------------|-----|-------|
| REV. | DESCRIPTION | BY: | DATE: |
| | | | |
| | | | |
| | | | |

CONFIDENTIAL

| | | | |
|-----------|--------|--------|-----------|
| ENGINEER: | N/A | DATE: | 9/19/2016 |
| PAGE: | 1 OF 1 | DRAWN: | HUGO.R |

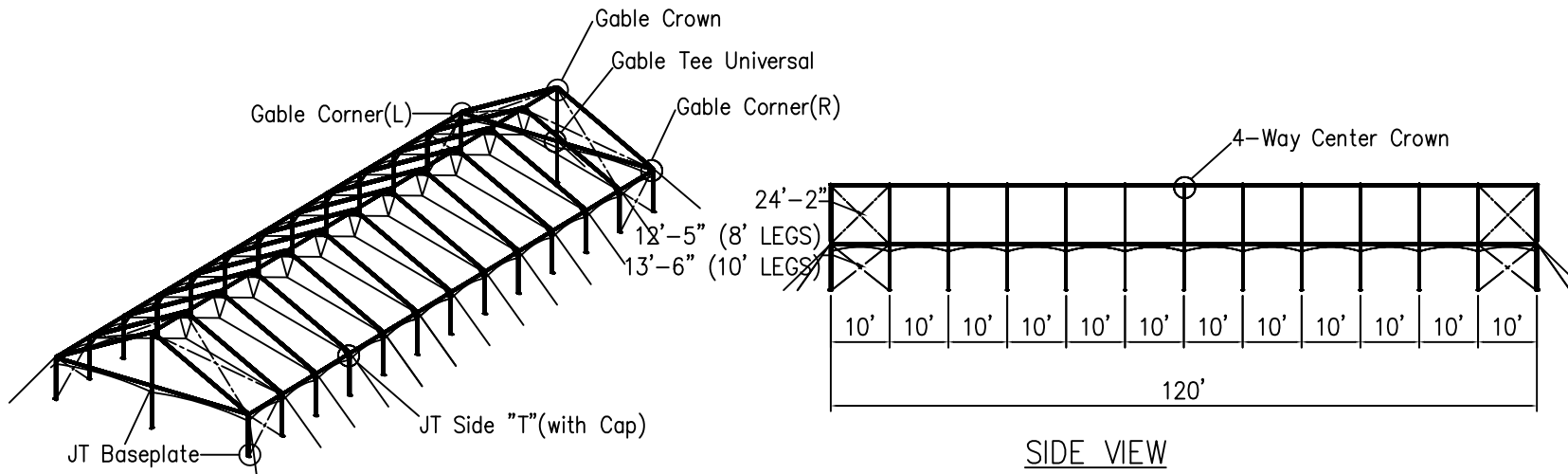

ISOMETRIC VIEW

SIDE VIEW

40'x120' JUMBOTRAC GABLE FRAME TENT

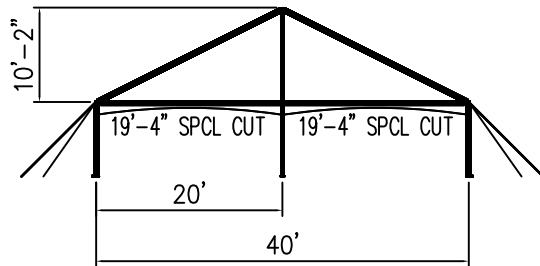

VIEW A-A

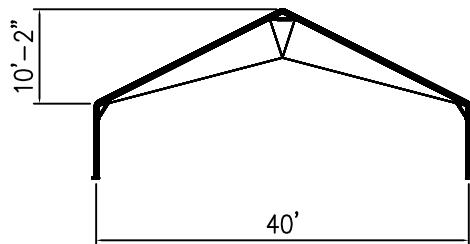

SECTION B-B

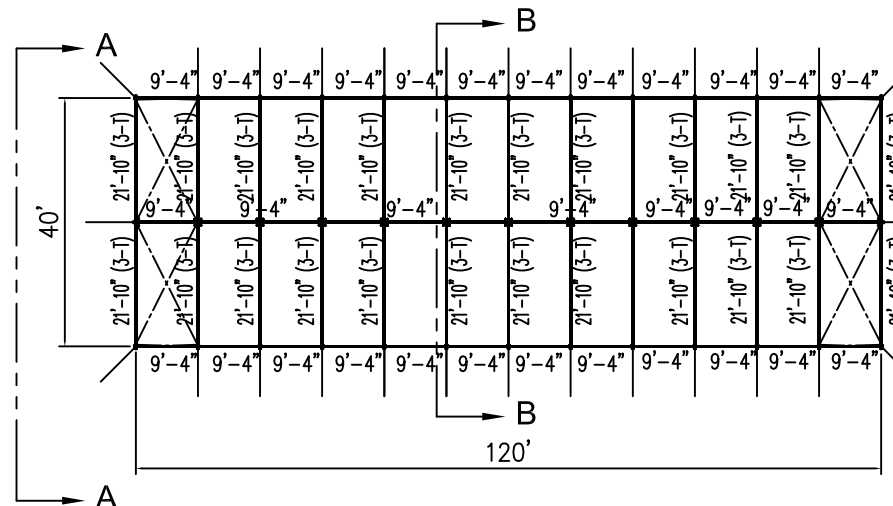

PLAN VIEW

ALL DATA AND INFORMATION CONTAINED IN OR DISCLOSED BY THIS DOCUMENT IS CONFIDENTIAL AND PROPRIETARY INFORMATION OF AZTEC TENTS AND ALL RIGHTS THEREIN ARE EXPRESSLY RESERVED. BY ACCEPTING THIS MATERIAL THE RECIPIENT AGREES THAT THIS MATERIAL AND INFORMATION CONTAINED THEREIN IS HELD IN CONFIDENCE AND IN TRUST AND WILL NOT BE COPIED, REPRODUCED WHOLE OR IN PART, NOR ITS CONTENTS REVEALED IN ANY MANNER TO OTHERS, EXCEPT TO MEET THE SPECIFIC PURPOSE FOR WHICH IT WAS DELIVERED.

AZTEC TENTS
 DESIGN & PRODUCTION
 2665 COLUMBIA ST. TORRANCE, CA. 90503
 (800) 228-3687 - FAX (310) 381-0722

GABLE FRAME
 CENTER CLEAR STRUCTURE/STANDARD
 40' W X 120'
 PART NUMBER: ZXXXXXXX

| REVISION HISTORY | | | |
|------------------|-------------|-----|-------|
| REV. | DESCRIPTION | BY: | DATE: |
| N/A | N/A | N/A | N/A |
| N/A | N/A | N/A | N/A |
| N/A | N/A | N/A | N/A |
| N/A | N/A | N/A | N/A |
| N/A | N/A | N/A | N/A |

CONFIDENTIAL

ENGINEER: N/A DATE: 8/11/2016
 PAGE: 1 OF 1 DRAWN: HUGO.R

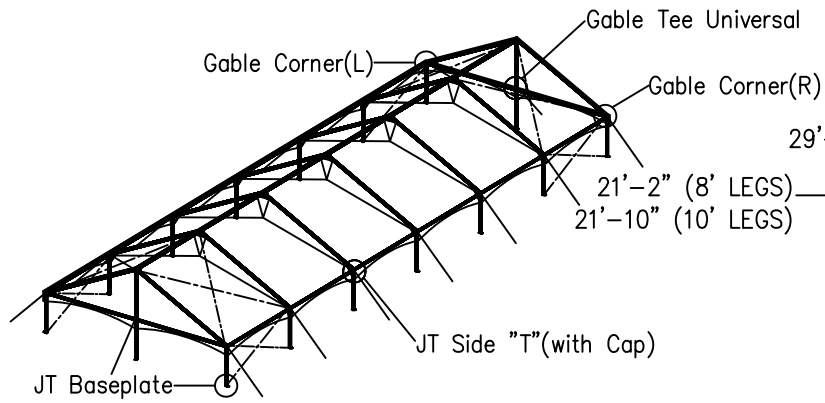

ISOMETRIC VIEW

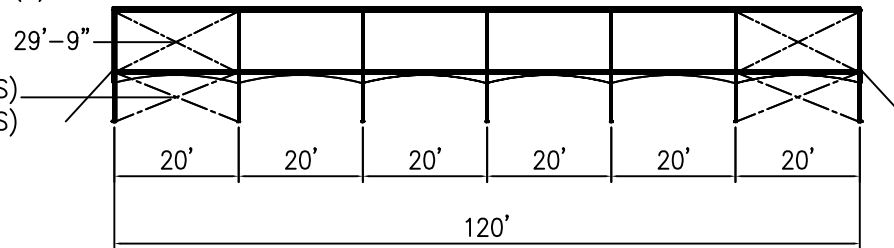

SIDE VIEW

40'x120' JUMBOTRAC GABLE FRAME TENT

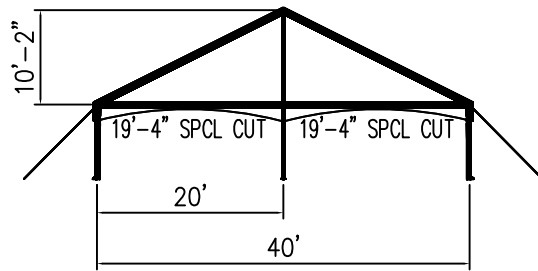

VIEW A-A

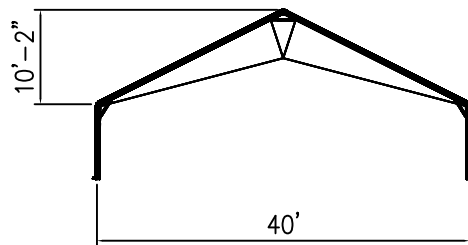

VIEW B-B

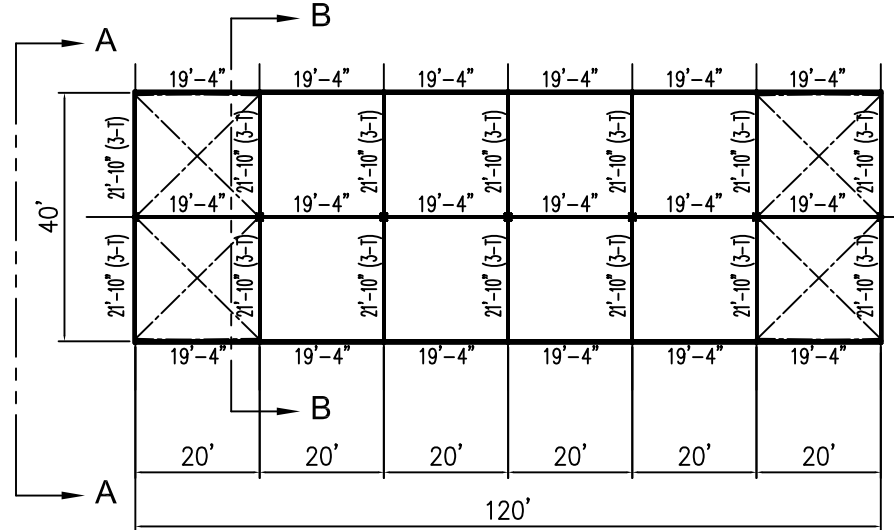

PLAN VIEW

ALL DATA AND INFORMATION CONTAINED IN OR DISCLOSED BY THIS DOCUMENT IS CONFIDENTIAL AND PROPRIETARY INFORMATION OF AZTEC TENTS AND ALL RIGHTS THEREIN ARE EXPRESSLY RESERVED. BY ACCEPTING THIS MATERIAL THE RECIPIENT AGREES THAT THIS MATERIAL AND INFORMATION CONTAINED THEREIN IS HELD IN CONFIDENCE AND IN TRUST AND WILL NOT BE COPIED, REPRODUCED WHOLE OR IN PART, NOR ITS CONTENTS REVEALED IN ANY MANNER TO OTHERS, EXCEPT TO MEET THE SPECIFIC PURPOSE FOR WHICH IT WAS DELIVERED.

AZTEC TENTS
 DESIGN & PRODUCTION
 2665 COLUMBIA ST. TORRANCE, CA. 90503
 (800) 228-3687 - FAX (310) 381-0722

GABLE FRAME
 CENTER CLEAR STRUCTURE/STANDARD
 40' W X 120' L
 PART NUMBER: ZXXXXXXX

| REVISION HISTORY | | | |
|------------------|-------------|-----|-------|
| REV. | DESCRIPTION | BY: | DATE: |
| | | | |
| | | | |
| | | | |

CONFIDENTIAL

| | | | |
|-----------|--------|--------|-----------|
| ENGINEER: | N/A | DATE: | 9/19/2016 |
| PAGE: | 1 OF 1 | DRAWN: | HUGO.R |

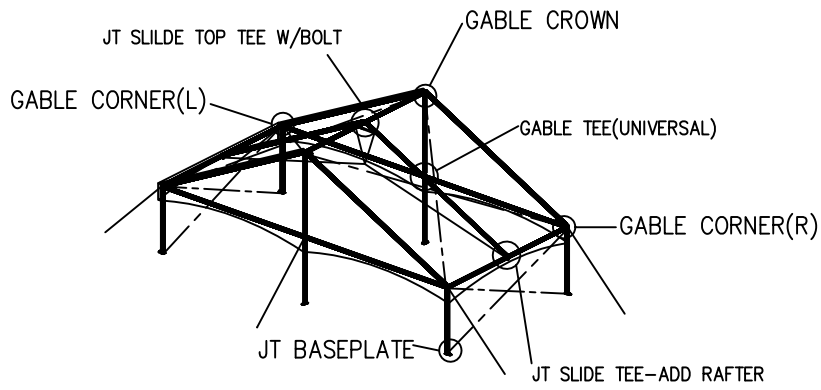

ISOMETRIC VIEW

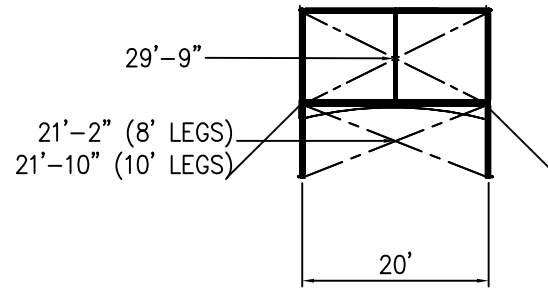

SIDE VIEW

40'x20' JUMBOTRAC GABLE FRAME TENT

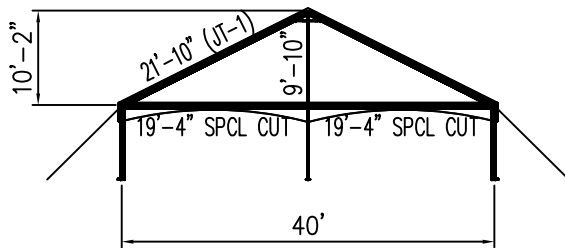

FRONT VIEW

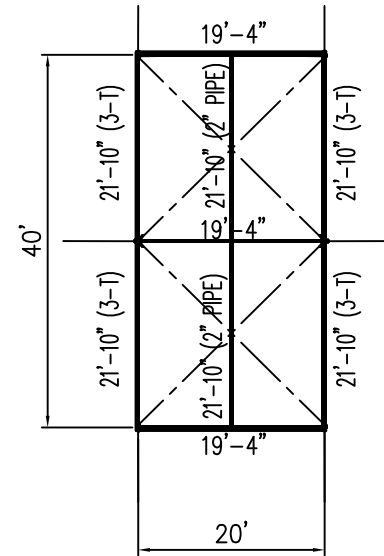

PLAN VIEW

ALL DATA AND INFORMATION CONTAINED IN OR DISCLOSED BY THIS DOCUMENT IS CONFIDENTIAL AND PROPRIETARY INFORMATION OF AZTEC TENTS AND ALL RIGHTS THEREIN ARE EXPRESSLY RESERVED. BY ACCEPTING THIS MATERIAL THE RECIPIENT AGREES THAT THIS MATERIAL AND INFORMATION CONTAINED THEREIN IS HELD IN CONFIDENCE AND IN TRUST AND WILL NOT BE COPIED, REPRODUCED WHOLE OR IN PART, NOR ITS CONTENTS REVEALED IN ANY MANNER TO OTHERS, EXCEPT TO MEET THE SPECIFIC PURPOSE FOR WHICH IT WAS DELIVERED.

AZTEC TENTS
 DESIGN & PRODUCTION
 2665 COLUMBIA ST. TORRANCE, CA. 90503
 (800) 228-3687 - FAX (310) 381-0722

GABLE FRAME
 GABLE/STANDARD
 40'W X 20'L
 PART NUMBER: ZXXXXXX

| REVISION HISTORY | | | |
|------------------|-------------------|-----|--------|
| REV. | DESCRIPTION | BY: | DATE: |
| 1 | CHANGE IN DETAILS | LR | 4/7/17 |
| | | | |
| | | | |

CONFIDENTIAL

ENGINEER: N/A DATE: 8/11/2016
 PAGE: 1 OF 1 DRAWN: HUGO.R

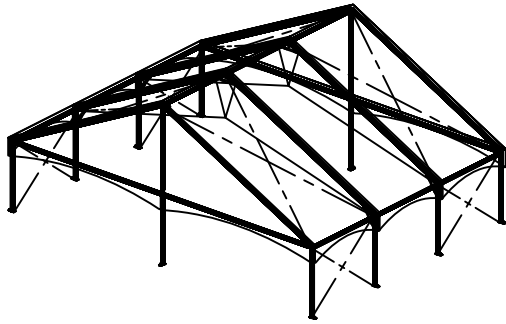

ISOMETRIC VIEW

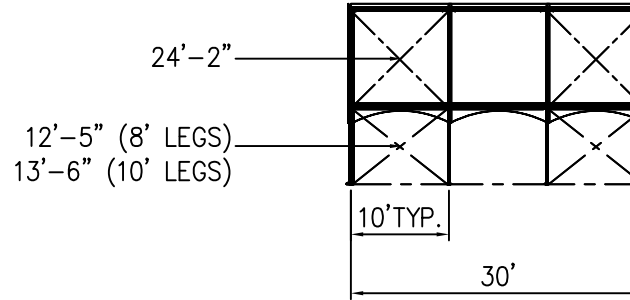

SIDE VIEW

40'x30' GABLE JUMBOTRAC

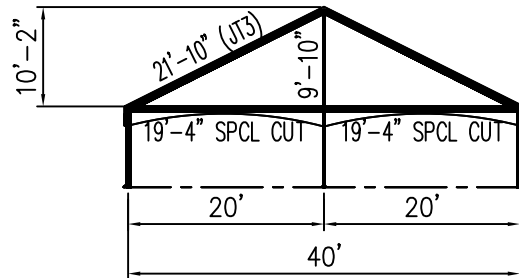

VIEW A-A

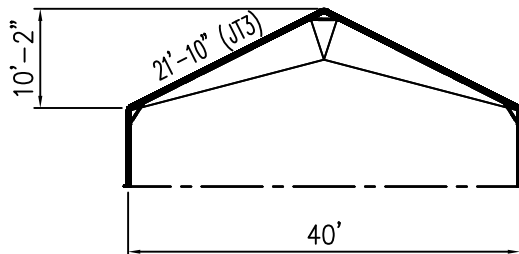

VIEW B-B

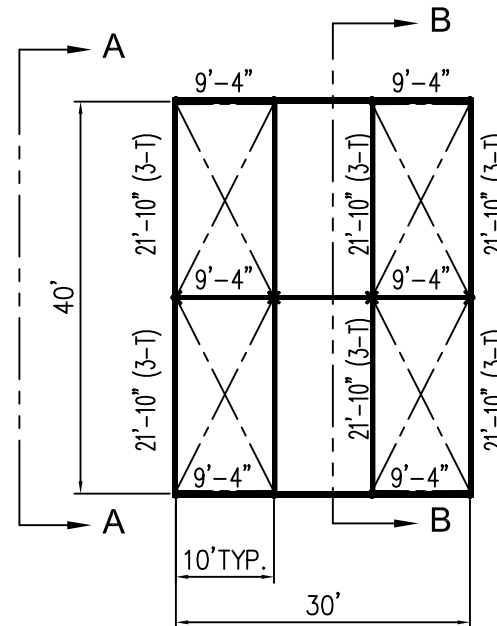

PLAN VIEW

ALL DATA AND INFORMATION CONTAINED IN OR DISCLOSED BY THIS DOCUMENT IS CONFIDENTIAL AND PROPRIETARY INFORMATION OF AZTEC TENTS AND ALL RIGHTS THEREIN ARE EXPRESSLY RESERVED. BY ACCEPTING THIS MATERIAL THE RECIPIENT AGREES THAT THIS MATERIAL AND INFORMATION CONTAINED THEREIN IS HELD IN CONFIDENCE AND IN TRUST AND WILL NOT BE COPIED, REPRODUCED WHOLE OR IN PART, NOR ITS CONTENTS REVEALED IN ANY MANNER TO OTHERS, EXCEPT TO MEET THE SPECIFIC PURPOSE FOR WHICH IT WAS DELIVERED.

AZTEC TENTS
 DESIGN & PRODUCTION
 2665 COLUMBIA ST. TORRANCE, CA. 90503
 (800) 228-3687 - FAX (310) 381-0722

JUMBOTRAC FRAME
 JUMBOTRAC FRAME / STANDARD
 40'W x 30'L x 10' BAYS
 PART NUMBER: ZXXXXXX

| REVISION HISTORY | | | |
|------------------|-------------|-----|-------|
| REV. | DESCRIPTION | BY: | DATE: |
| | | | |
| | | | |
| | | | |

CONFIDENTIAL

| | | | |
|-----------|--------|--------|------------|
| ENGINEER: | N/A | DATE: | 10/19/2017 |
| PAGE: | 1 OF 1 | DRAWN: | LYZ R. |

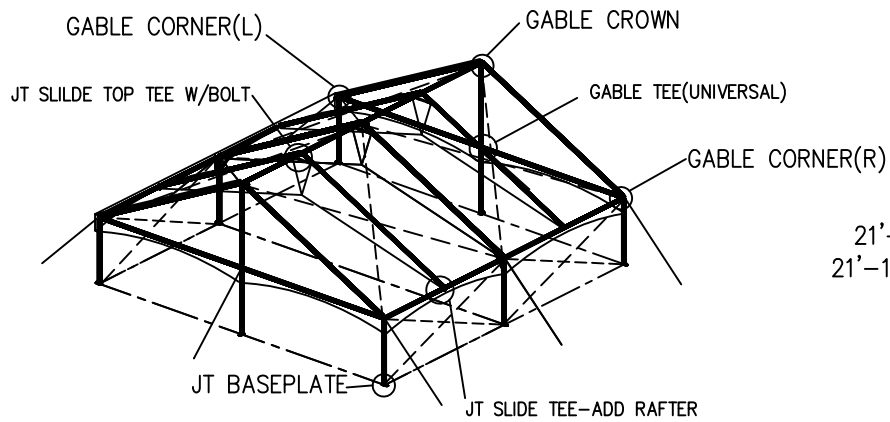

ISOMETRIC VIEW

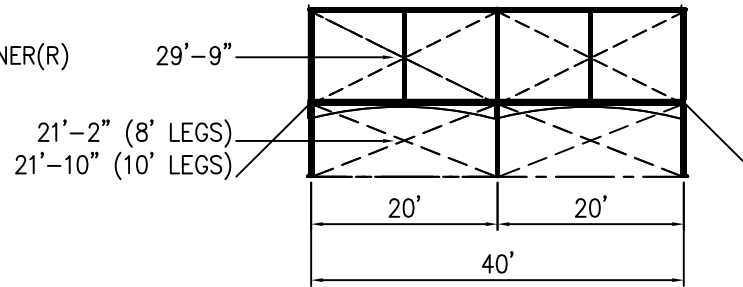

SIDE VIEW

40'x40' GABLE JUMBOTRAC

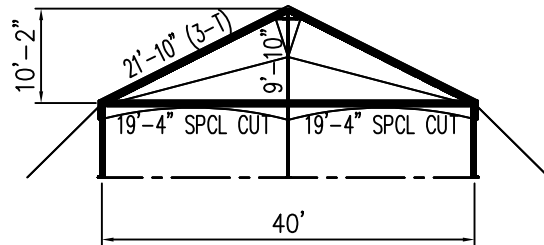

VIEW A-A

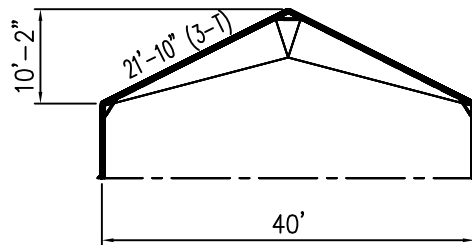

VIEW B-B

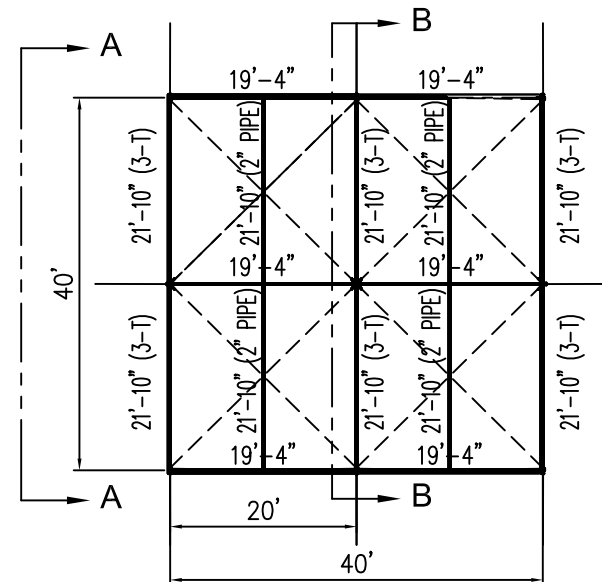

PLAN VIEW

ALL DATA AND INFORMATION CONTAINED IN OR DISCLOSED BY THIS DOCUMENT IS CONFIDENTIAL AND PROPRIETARY INFORMATION OF AZTEC TENTS AND ALL RIGHTS THEREIN ARE EXPRESSLY RESERVED. BY ACCEPTING THIS MATERIAL THE RECIPIENT AGREES THAT THIS MATERIAL AND INFORMATION CONTAINED THEREIN IS HELD IN CONFIDENCE AND IN TRUST AND WILL NOT BE COPIED, REPRODUCED WHOLE OR IN PART, NOR ITS CONTENTS REVEALED IN ANY MANNER TO OTHERS, EXCEPT TO MEET THE SPECIFIC PURPOSE FOR WHICH IT WAS DELIVERED.

AZTEC TENTS
 DESIGN & PRODUCTION
 2665 COLUMBIA ST. TORRANCE, CA. 90503
 (800) 228-3687 - FAX (310) 381-0722

JUMBOTRAC FRAME
 JUMBOTRAC/GABLE ENDS
 40'W X 40'L X 20'BAYS
 PART NUMBER: ZXXXXXX

| REVISION HISTORY | | | |
|------------------|------------------|-----|--------|
| REV. | DESCRIPTION | BY | DATE |
| 1 | CHANGE IN DETAIL | L.R | 4/7/17 |
| | | | |
| | | | |

CONFIDENTIAL

| | | | |
|-----------|--------|--------|----------|
| ENGINEER: | N/A | DATE: | 5/4/2016 |
| PAGE: | 1 OF 1 | DRAWN: | HUGO.R |

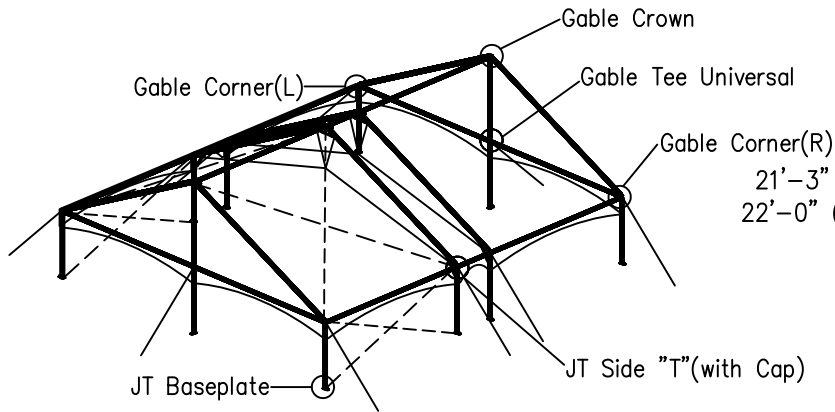

ISOMETRIC VIEW

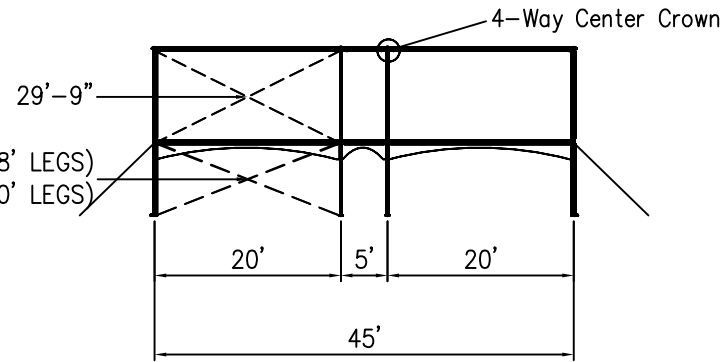

SIDE VIEW

40'x45' JUMBOTRAC GABLE FRAME TENT

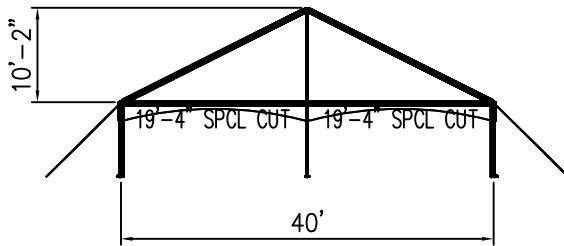

VIEW A-A

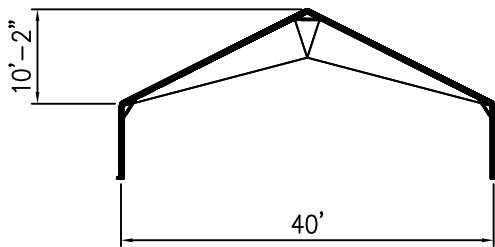

SECTION B-B

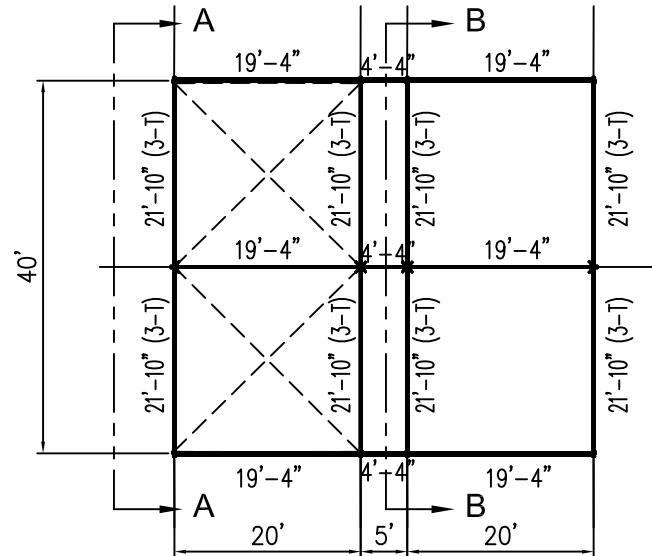

PLAN VIEW

ALL DATA AND INFORMATION CONTAINED IN OR DISCLOSED BY THIS DOCUMENT IS CONFIDENTIAL AND PROPRIETARY INFORMATION OF AZTEC TENTS AND ALL RIGHTS THEREIN ARE EXPRESSLY RESERVED. BY ACCEPTING THIS MATERIAL THE RECIPIENT AGREES THAT THIS MATERIAL AND INFORMATION CONTAINED THEREIN IS HELD IN CONFIDENCE AND IN TRUST AND WILL NOT BE COPIED, REPRODUCED WHOLE OR IN PART, NOR ITS CONTENTS REVEALED IN ANY MANNER TO OTHERS, EXCEPT TO MEET THE SPECIFIC PURPOSE FOR WHICH IT WAS DELIVERED.

AZTEC TENTS
 DESIGN & PRODUCTION
 2665 COLUMBIA ST. TORRANCE, CA. 90503
 (800) 228-3687 - FAX (310) 381-0722

GABLE FRAME
 CENTER CLEAR STRUCTURE/STANDARD
 40'W X 45'L
 PART NUMBER: ZXXXXXXX

| REVISION HISTORY | | | |
|------------------|-------------|-----|-------|
| REV. | DESCRIPTION | BY: | DATE: |
| | | | |
| | | | |
| | | | |

CONFIDENTIAL

| | | | |
|-----------|--------|--------|-----------|
| ENGINEER: | N/A | DATE: | 8/11/2016 |
| PAGE: | 1 OF 1 | DRAWN: | HUGO.R |

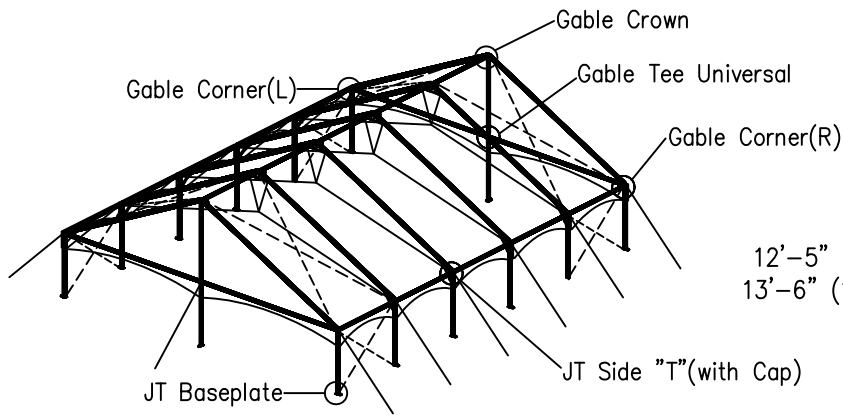

ISOMETRIC VIEW

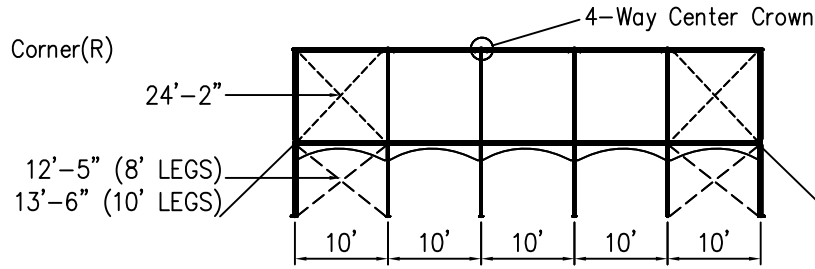

SIDE VIEW

40' x 50' JUMBOTRAC GABLE FRAME TENT

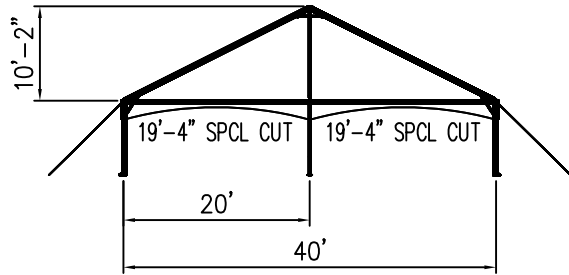

VIEW A-A

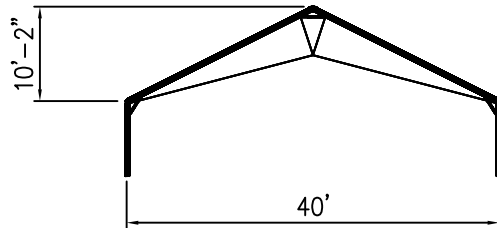

SECTION B-B

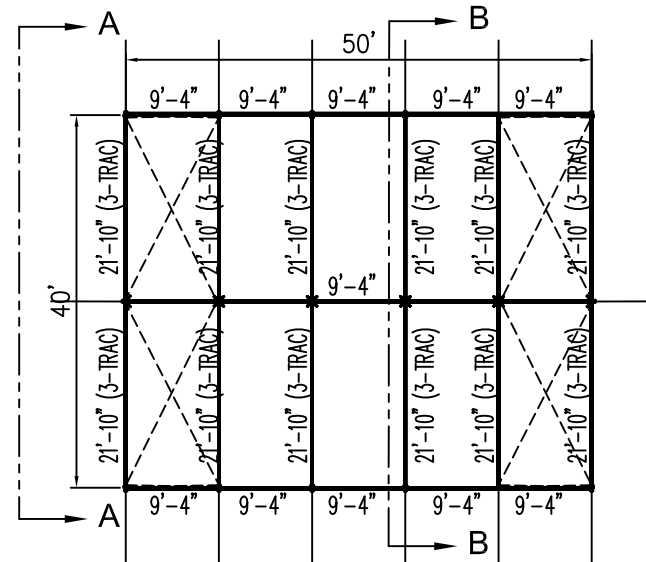

PLAN VIEW

ALL DATA AND INFORMATION CONTAINED IN OR DISCLOSED BY THIS DOCUMENT IS CONFIDENTIAL AND PROPRIETARY INFORMATION OF AZTEC TENTS AND ALL RIGHTS THEREIN ARE EXPRESSLY RESERVED. BY ACCEPTING THIS MATERIAL THE RECIPIENT AGREES THAT THIS MATERIAL AND INFORMATION CONTAINED THEREIN IS HELD IN CONFIDENCE AND IN TRUST AND WILL NOT BE COPIED, REPRODUCED WHOLE OR IN PART, NOR ITS CONTENTS REVEALED IN ANY MANNER TO OTHERS, EXCEPT TO MEET THE SPECIFIC PURPOSE FOR WHICH IT WAS DELIVERED.

AZTEC TENTS
 DESIGN & PRODUCTION
 2665 COLUMBIA ST. TORRANCE, CA. 90503
 (800) 228-3687 - FAX (310) 381-0722

GABLE FRAME
 CENTER CLEAR STRUCTURE/STANDARD
 40'W X 50'L
 PART NUMBER: ZXXXXXX

| REVISION HISTORY | | | |
|------------------|-------------|-----|-------|
| REV. | DESCRIPTION | BY: | DATE: |
| | | | |
| | | | |
| | | | |

CONFIDENTIAL

ENGINEER: N/A DATE: 7/20/2016
 PAGE: 1 OF 1 DRAWN: HUGO.R

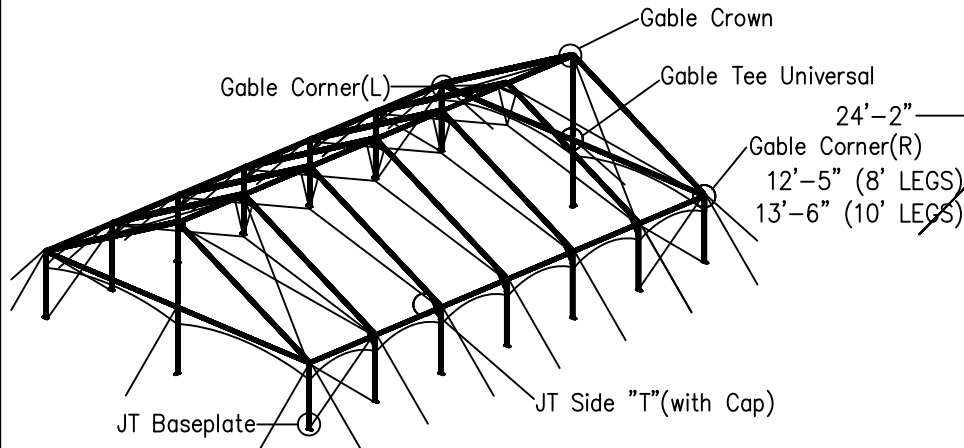

ISOMETRIC VIEW

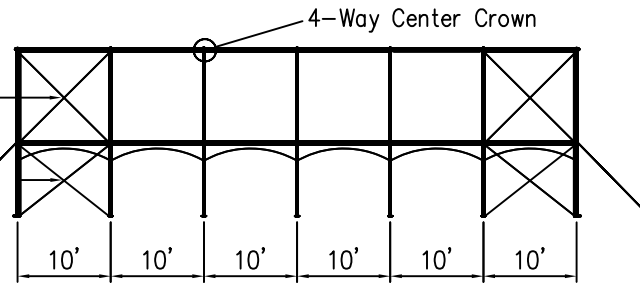

SIDE VIEW

40'x60' JUMBOTRAC GABLE FRAME TENT

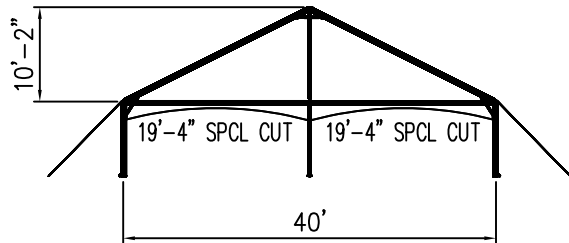

VIEW A-A

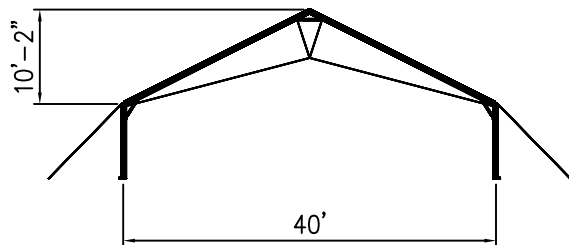

SECTION B-B

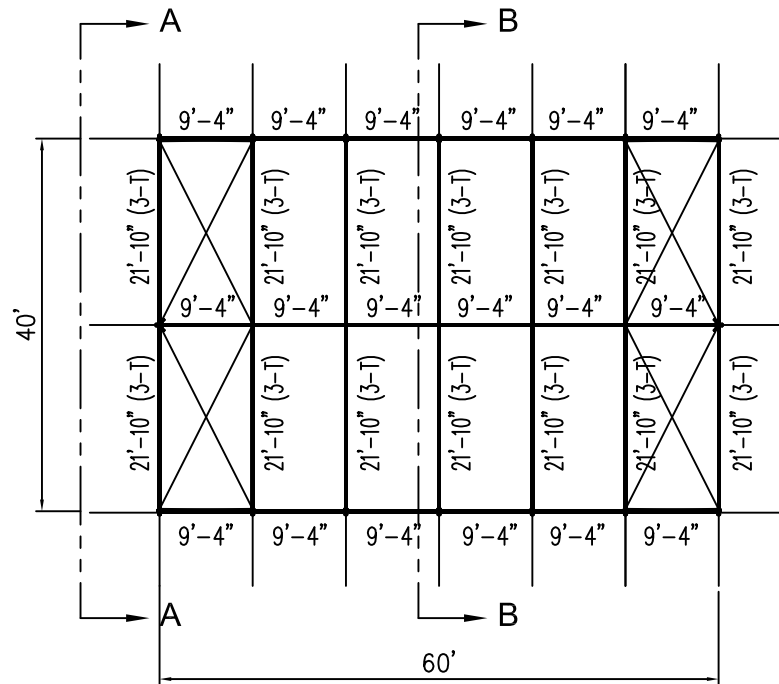

PLAN VIEW

ALL DATA AND INFORMATION CONTAINED IN OR DISCLOSED BY THIS DOCUMENT IS CONFIDENTIAL AND PROPRIETARY INFORMATION OF AZTEC TENTS AND ALL RIGHTS THEREIN ARE EXPRESSLY RESERVED. BY ACCEPTING THIS MATERIAL THE RECIPIENT AGREES THAT THIS MATERIAL AND INFORMATION CONTAINED THEREIN IS HELD IN CONFIDENCE AND IN TRUST AND WILL NOT BE COPIED, REPRODUCED WHOLE OR IN PART, NOR ITS CONTENTS REVEALED IN ANY MANNER TO OTHERS, EXCEPT TO MEET THE SPECIFIC PURPOSE FOR WHICH IT WAS DELIVERED.

AZTEC TENTS
 DESIGN & PRODUCTION
 2665 COLUMBIA ST. TORRANCE, CA. 90503
 (800) 228-3687 - FAX (310) 381-0722

GABLE FRAME
 CENTER CLEAR STRUCTURE/STANDARD
 40'W X 60'L
 PART NUMBER: ZXXXXXXX

| REVISION HISTORY | | | |
|------------------|-------------|-----|-------|
| REV. | DESCRIPTION | BY: | DATE: |
| N/A | N/A | N/A | N/A |
| N/A | N/A | N/A | N/A |
| N/A | N/A | N/A | N/A |
| N/A | N/A | N/A | N/A |
| N/A | N/A | N/A | N/A |

CONFIDENTIAL

ENGINEER: N/A DATE: 8/11/2016
 PAGE: 1 OF 1 DRAWN: HUGO.R

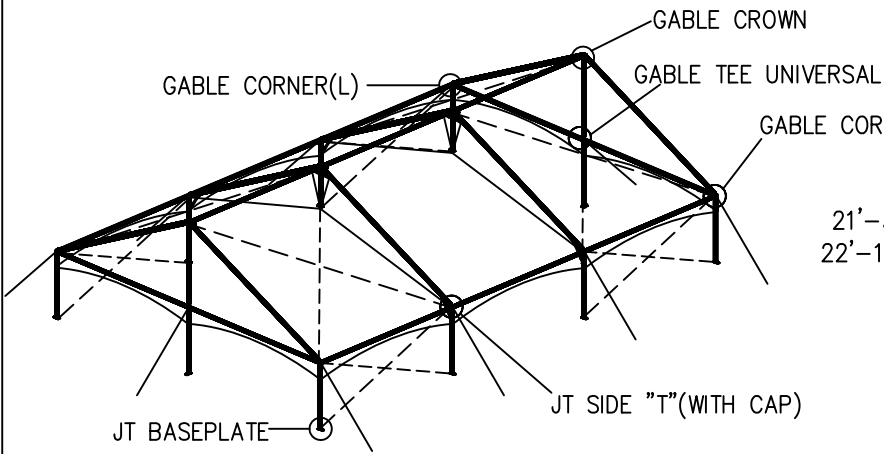

ISOMETRIC VIEW

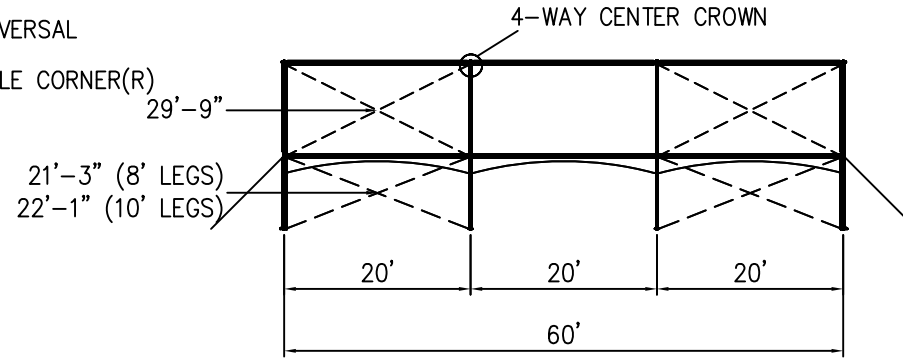

SIDE VIEW

40'x60' JUMBOTRAC GABLE FRAME TENT

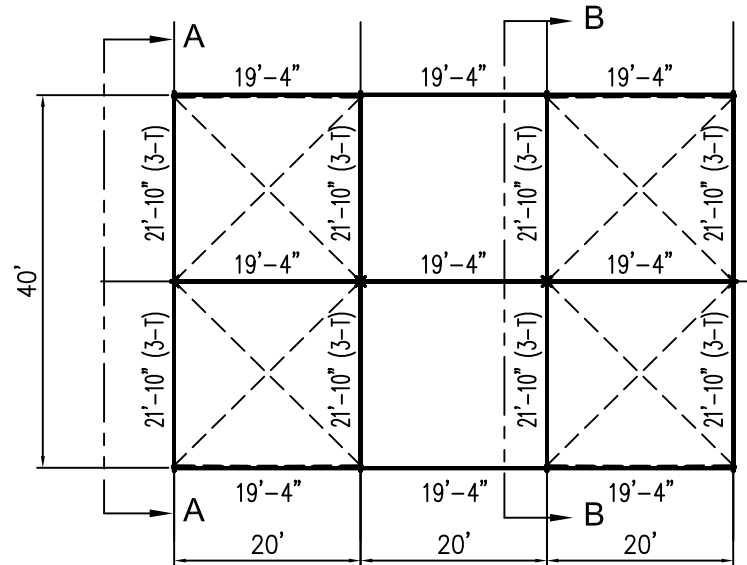
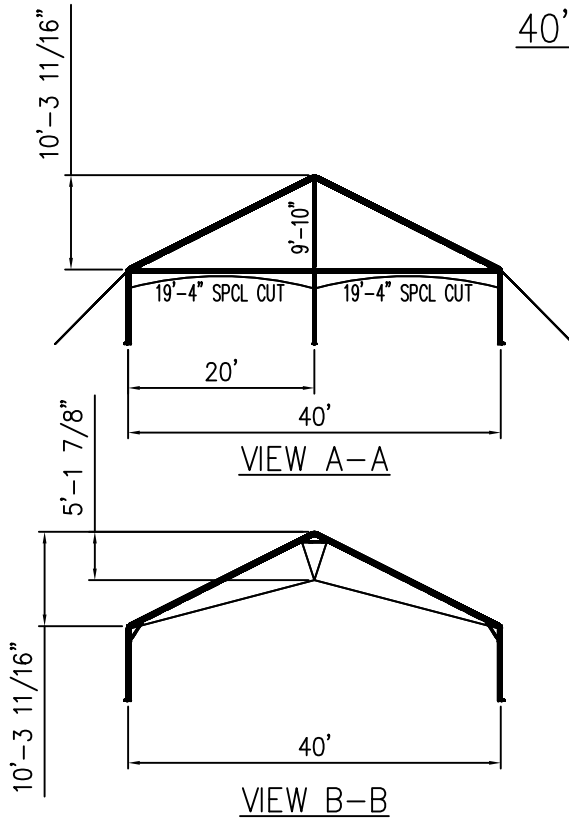

PLAN VIEW

ALL DATA AND INFORMATION CONTAINED IN OR DISCLOSED BY THIS DOCUMENT IS CONFIDENTIAL AND PROPRIETARY INFORMATION OF AZTEC TENTS AND ALL RIGHTS THEREIN ARE EXPRESSLY RESERVED. BY ACCEPTING THIS MATERIAL THE RECIPIENT AGREES THAT THIS MATERIAL AND INFORMATION CONTAINED THEREIN IS HELD IN CONFIDENCE AND IN TRUST AND WILL NOT BE COPIED, REPRODUCED WHOLE OR IN PART, NOR ITS CONTENTS REVEALED IN ANY MANNER TO OTHERS, EXCEPT TO MEET THE SPECIFIC PURPOSE FOR WHICH IT WAS DELIVERED.

AZTEC TENTS
 DESIGN & PRODUCTION
 2665 COLUMBIA ST. TORRANCE, CA. 90503
 (800) 228-3687 - FAX (310) 381-0722

GABLE FRAME
 CENTER CLEAR STRUCTURE/STANDARD
 40'W X 60'L
 PART NUMBER: ZXXXXXXX

| REVISION HISTORY | | | |
|------------------|-------------|-----|-------|
| REV. | DESCRIPTION | BY: | DATE: |
| | | | |
| | | | |
| | | | |

CONFIDENTIAL

ENGINEER: N/A DATE: 9/16/2016
 PAGE: 1 OF 1 DRAWN: HUGO.R

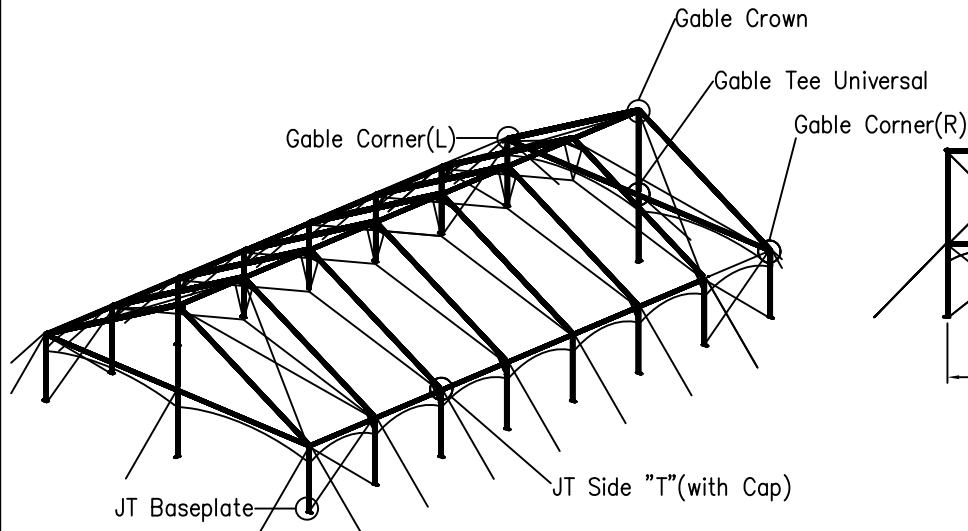

ISOMETRIC VIEW

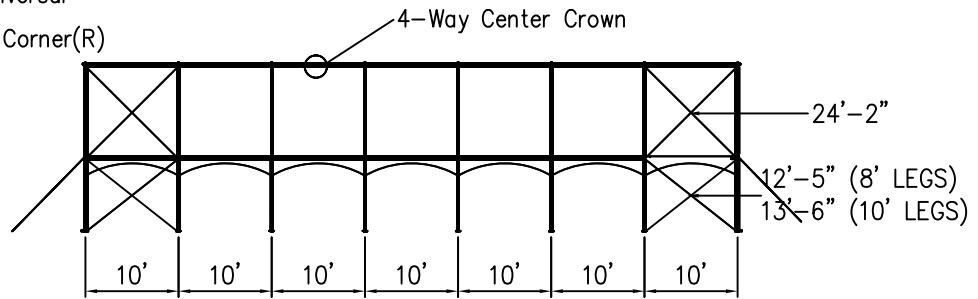

SIDE VIEW

40'x70' JUMBOTRAC GABLE FRAME TENT

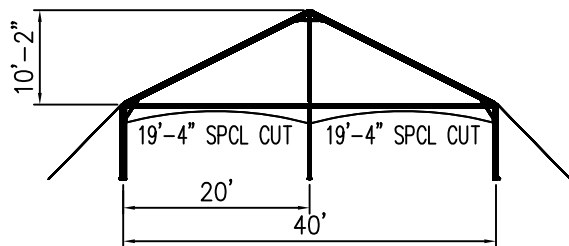

VIEW A-A

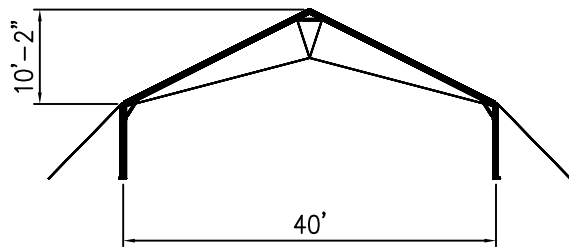

SECTION B-B

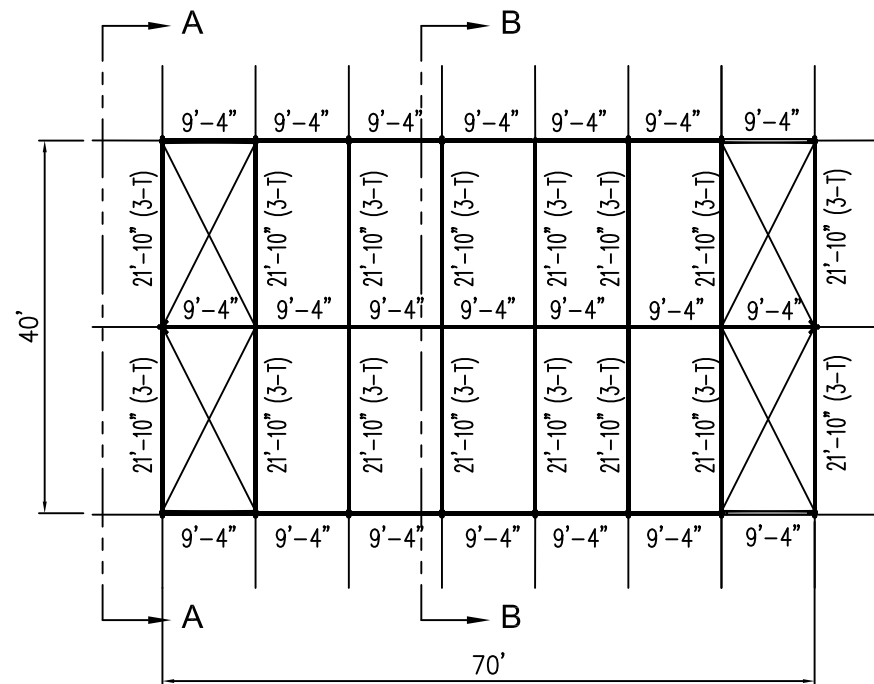

PLAN VIEW

ALL DATA AND INFORMATION CONTAINED IN OR DISCLOSED BY THIS DOCUMENT IS CONFIDENTIAL AND PROPRIETARY INFORMATION OF AZTEC TENTS AND ALL RIGHTS THEREIN ARE EXPRESSLY RESERVED. BY ACCEPTING THIS MATERIAL THE RECIPIENT AGREES THAT THIS MATERIAL AND INFORMATION CONTAINED THEREIN IS HELD IN CONFIDENCE AND IN TRUST AND WILL NOT BE COPIED, REPRODUCED WHOLE OR IN PART, NOR ITS CONTENTS REVEALED IN ANY MANNER TO OTHERS, EXCEPT TO MEET THE SPECIFIC PURPOSE FOR WHICH IT WAS DELIVERED.

AZTEC TENTS
 DESIGN & PRODUCTION
 2665 COLUMBIA ST. TORRANCE, CA. 90503
 (800) 228-3687 - FAX (310) 381-0722

GABLE FRAME
 CENTER CLEAR STRUCTURE/STANDARD
 40' X 70'
 PART NUMBER: ZXXXXXX

| REVISION HISTORY | | | |
|------------------|-------------|-----|-------|
| REV. | DESCRIPTION | BY: | DATE: |
| N/A | N/A | N/A | N/A |
| N/A | N/A | N/A | N/A |
| N/A | N/A | N/A | N/A |
| N/A | N/A | N/A | N/A |
| N/A | N/A | N/A | N/A |

CONFIDENTIAL

ENGINEER: N/A DATE: 8/11/2016
 PAGE: 1 OF 1 DRAWN: HUGO.R

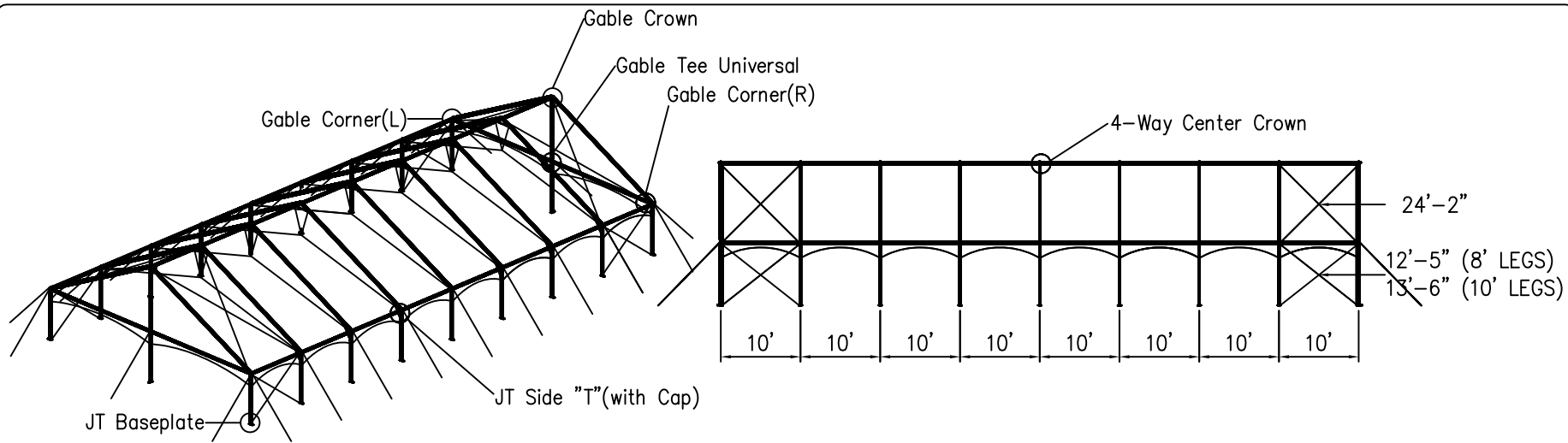

ISOMETRIC VIEW

SIDE VIEW

40'x80' JUMBOTRAC GABLE FRAME TENT

ALL DATA AND INFORMATION CONTAINED IN OR DISCLOSED BY THIS DOCUMENT IS CONFIDENTIAL AND PROPRIETARY INFORMATION OF AZTEC TENTS AND ALL RIGHTS THEREIN ARE EXPRESSLY RESERVED. BY ACCEPTING THIS MATERIAL THE RECIPIENT AGREES THAT THIS MATERIAL AND INFORMATION CONTAINED THEREIN IS HELD IN CONFIDENCE AND IN TRUST AND WILL NOT BE COPIED, REPRODUCED WHOLE OR IN PART, NOR ITS CONTENTS REVEALED IN ANY MANNER TO OTHERS, EXCEPT TO MEET THE SPECIFIC PURPOSE FOR WHICH IT WAS DELIVERED.

AZTEC TENTS
 DESIGN & PRODUCTION
 2665 COLUMBIA ST. TORRANCE, CA. 90503
 (800) 228-3687 - FAX (310) 381-0722

GABLE FRAME
 CENTER CLEAR STRUCTURE/STANDARD
 40' X 80'
 PART NUMBER: ZXXXXXXX

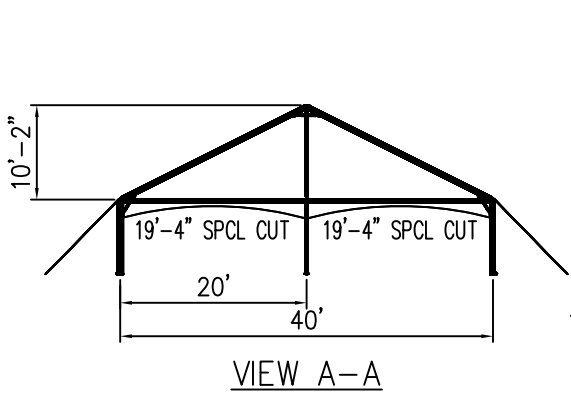

VIEW A-A

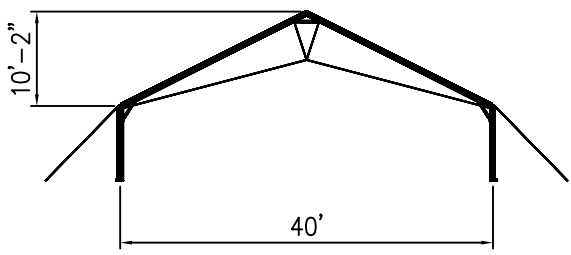

SECTION B-B

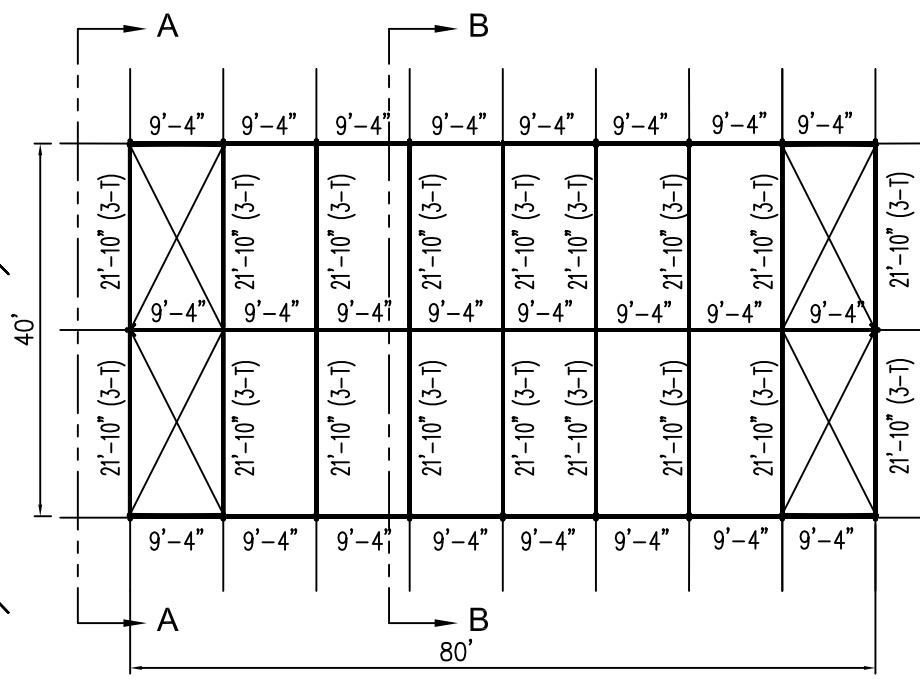

PLAN VIEW

| REVISION HISTORY | | | |
|------------------|-------------|-----|-------|
| REV. | DESCRIPTION | BY: | DATE: |
| N/A | N/A | N/A | N/A |
| N/A | N/A | N/A | N/A |
| N/A | N/A | N/A | N/A |
| N/A | N/A | N/A | N/A |
| N/A | N/A | N/A | N/A |

CONFIDENTIAL

ENGINEER: N/A DATE: 8/11/2016
 PAGE: 1 OF 1 DRAWN: HUGO.R

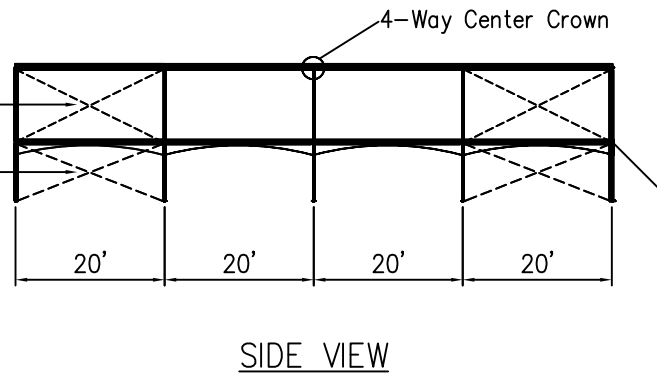
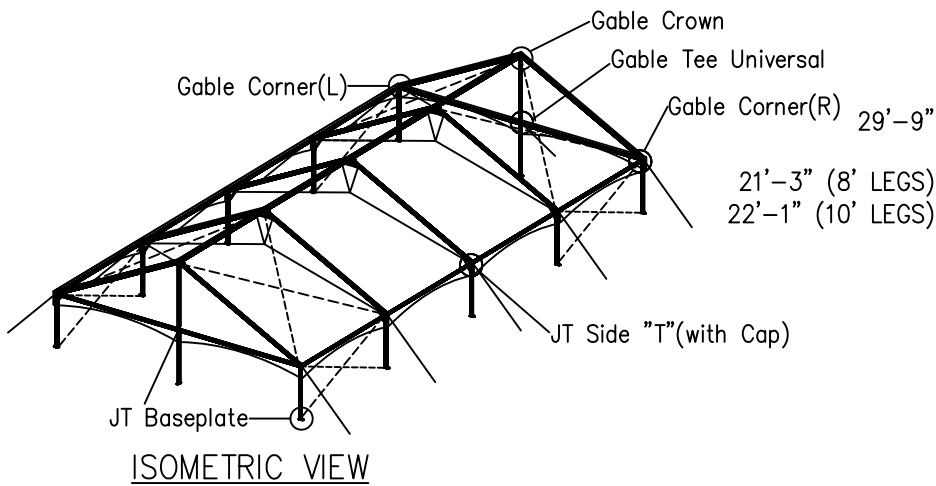

40'x80' JUMBOTRAC GABLE FRAME TENT

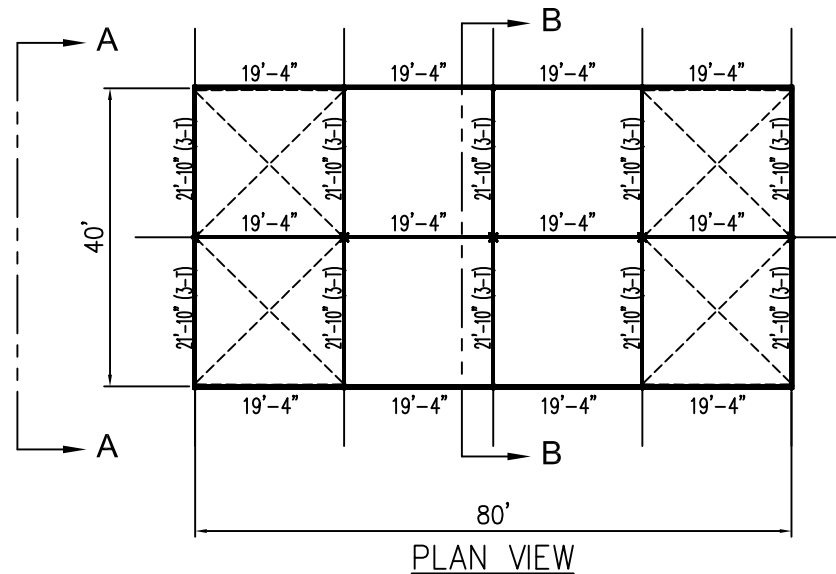
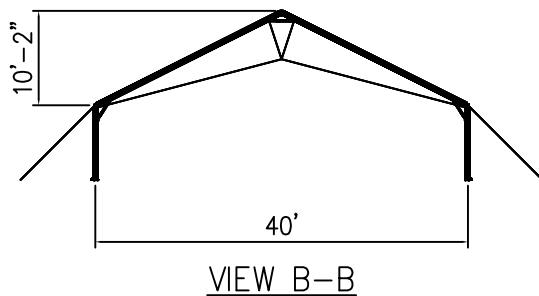
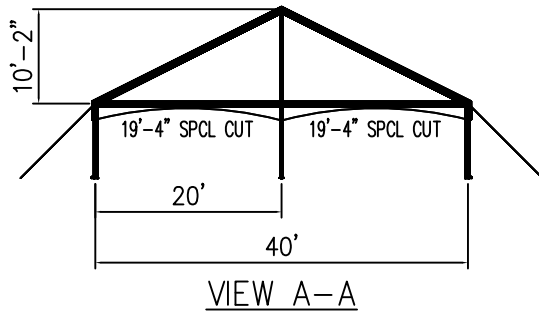

ALL DATA AND INFORMATION CONTAINED IN OR DISCLOSED BY THIS DOCUMENT IS CONFIDENTIAL AND PROPRIETARY INFORMATION OF AZTEC TENTS AND ALL RIGHTS THEREIN ARE EXPRESSLY RESERVED. BY ACCEPTING THIS MATERIAL THE RECIPIENT AGREES THAT THIS MATERIAL AND INFORMATION CONTAINED THEREIN IS HELD IN CONFIDENCE AND IN TRUST AND WILL NOT BE COPIED, REPRODUCED WHOLE OR IN PART, NOR ITS CONTENTS REVEALED IN ANY MANNER TO OTHERS, EXCEPT TO MEET THE SPECIFIC PURPOSE FOR WHICH IT WAS DELIVERED.

AZTEC TENTS
 DESIGN & PRODUCTION
 2665 COLUMBIA ST. TORRANCE, CA. 90503
 (800) 228-3687 - FAX (310) 381-0722

GABLE FRAME
 CENTER CLEAR STRUCTURE/STANDARD
 40'W X 80'L
 PART NUMBER:

| REVISION HISTORY | | | |
|------------------|-------------|-----|-------|
| REV. | DESCRIPTION | BY: | DATE: |
| | | | |
| | | | |
| | | | |

CONFIDENTIAL

| | | | |
|-----------|--------|--------|-----------|
| ENGINEER: | N/A | DATE: | 12/3/2015 |
| PAGE: | 1 OF 1 | DRAWN: | ELVIS |

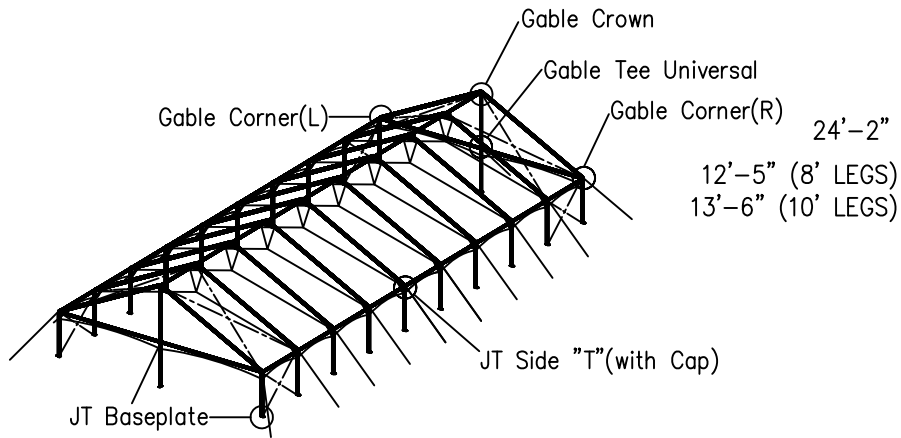

ISOMETRIC VIEW

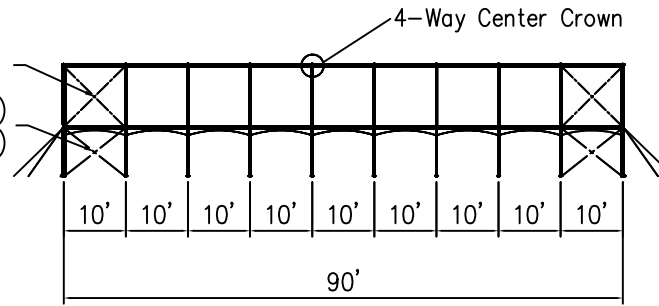

SIDE VIEW

40'x90' JUMBOTRAC GABLE FRAME TENT

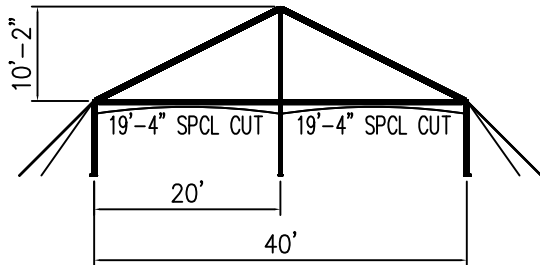

VIEW A-A

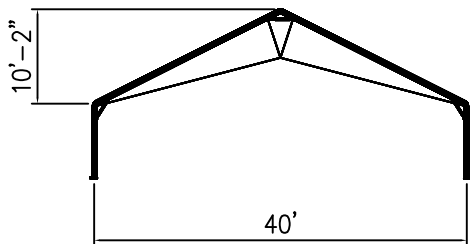

VIEW B-B

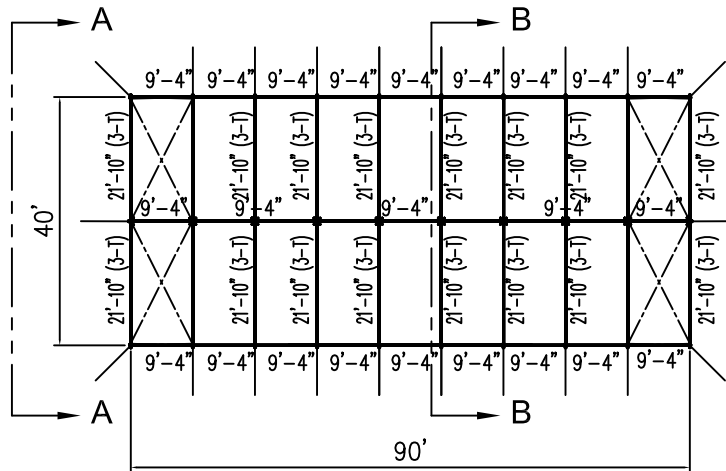

PLAN VIEW

ALL DATA AND INFORMATION CONTAINED IN OR DISCLOSED BY THIS DOCUMENT IS CONFIDENTIAL AND PROPRIETARY INFORMATION OF AZTEC TENTS AND ALL RIGHTS THEREIN ARE EXPRESSLY RESERVED. BY ACCEPTING THIS MATERIAL THE RECIPIENT AGREES THAT THIS MATERIAL AND INFORMATION CONTAINED THEREIN IS HELD IN CONFIDENCE AND IN TRUST AND WILL NOT BE COPIED, REPRODUCED WHOLE OR IN PART, NOR ITS CONTENTS REVEALED IN ANY MANNER TO OTHERS, EXCEPT TO MEET THE SPECIFIC PURPOSE FOR WHICH IT WAS DELIVERED.

AZTEC TENTS
 DESIGN & PRODUCTION
 2665 COLUMBIA ST. TORRANCE, CA. 90503
 (800) 228-3687 - FAX (310) 381-0722

GABLE FRAME
 CENTER CLEAR STRUCTURE/STANDARD
 40' W X 90'
 PART NUMBER: ZXXXXXX

| REVISION HISTORY | | | |
|------------------|-------------|-----|-------|
| REV. | DESCRIPTION | BY: | DATE: |
| N/A | N/A | N/A | N/A |
| N/A | N/A | N/A | N/A |
| N/A | N/A | N/A | N/A |
| N/A | N/A | N/A | N/A |
| N/A | N/A | N/A | N/A |

CONFIDENTIAL

ENGINEER: N/A DATE: 8/16/2016
 PAGE: 1 OF 1 DRAWN: HUGO.R