

INSTALL INSTRUCTIONS

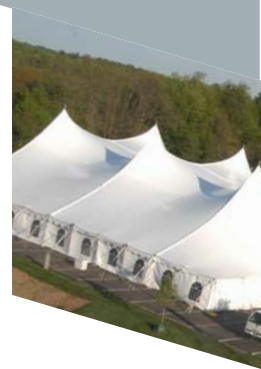

If YOU can IMAGINE it... WE can BUILD it

SERIES 2000

WARNING!

The safe installation and use of commercial tenting products can vary from site to site and during varying climactic conditions. Careful consideration should be paid to any installation during windy conditions and shall be monitored throughout the duration of the installation. Periodic maintenance and monitoring of the installation by the installer is required. Techniques other than those specified in this document may be required during these types of conditions.

Users and installers shall indemnify and hold harmless Aztec Tent for any claim resulting from the improper installation and/or maintenance of this unit.

Soil conditions also vary from site to site. The included anchoring package for this tent may need to be supplemented with alternate anchoring during windy conditions and in areas with questionable soil holding power. Full product engineering may be available.

NOTICE

This tent product is not intended to be used as a shelter from severe weather. Aztec assumes no liability for such use. An evacuation plan for the area covered within this tented space is imperative and shall be thoroughly posted for all users and potential occupants of the tent. Severe weather including electrical storm systems, moderate to severe wind, heavy rains, snow, or any condition that raises any doubt to the structural integrity of the tent are immediate signs that an evacuation is necessary. Severe bodily injury and/or death can occur.

The installation of electrical, plumbing, lighting, appliances and/or HVAC equipment are not covered within this manual. Users/Installers shall follow local code requirements for the installation of these items using certified personnel. Aztec Tents shall be indemnified and held harmless from any such use or injury resulting from its use.

IMPORTANT SAFETY INFORMATION

Proper personnel safety equipment should be worn at all times during the installation of any tenting products.

Hard Hat

Safety Glasses

Work Gloves

Long Pants

Steel Toe Boots

OSHA Approved Harness and restraint system (for off ground activities)

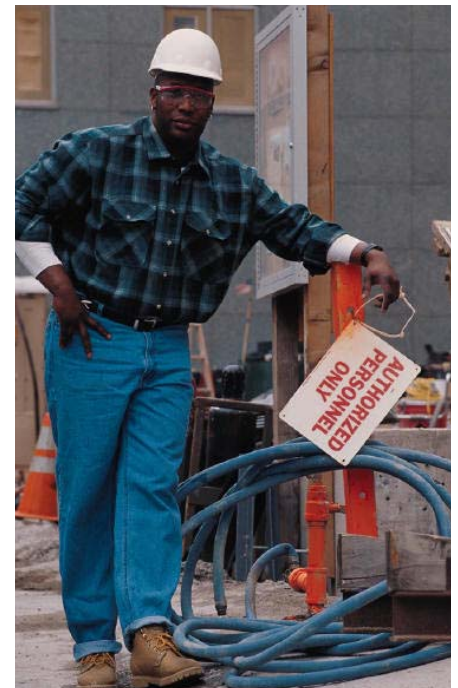

Thank you for your recent purchase from Aztec Tents. The following procedures will help you through your installation. If you ever run into problems with the installation of your Aztec Tent give one of our sales/service professionals a call. A complete listing of sales, service, and operational support is always available on our website at www.aztectents.com.

Contents

Install Instructions	3-8
Standard Diagrams	9-15
Anchoring Detail	16
Replacement Parts	17

Questions? Call us.

Aztec Tents

2665 Columbia Street
Torrance, CA 90503 USA
Direct (310) 347-3010
Toll Free (800) 228-3687
Fax (310) 381-0722

Installation Instructions

Step 1:

Square the tent area. Use the below squaring diagram to determine the diagonal or "C" Dimension your tent installation. To calculate your own squaring dimension for your width/length combination use the formula $A^2+B^2=C^2$.

		WIDTH- "A"						
		20'	30'	40'	50'	60'	80'	100'
LENGTH- "B"	20	28'3"	36'1"	44'9"	53'10"	63'3"	82'6"	102'
	30	36'1"	42'5"	50'	58'4"	67'1"	85'5"	104'5"
	40	44'9"	50'	56'7"	64'	72'1"	89'5"	107'8"
	50	53'10"	58'4"	64'	70'9"	78'1"	94'4"	111'10"
	60	63'3"	67'1"	72'1"	78'1"	84'10"	100'	116'7"
	70	72'10"	76'2"	80'7"	86'	92'2"	106'4"	122'1"
	80	82'6"	85'5"	89'5"	94'4"	100'	113'2"	128'1"
	90	92'2"	94'10"	98'6"	102'11"	108'2"	120'5"	134'6"
	100	102'	104'5"	107'8"	111'10"	116'7"	128'1"	141'5"
	120	121'8"	123'8"	126'6"	130'	134'2"	144'3"	156'2"
	130	131'6"	133'5"	136'	139'3"	143'2"	152'8"	164'
	140	141'5"	143'2"	145'7"	148'8"	152'4"	161'3"	172'
	150	151'4"	153'	155'3"	158'1"	161'7"	170'	180'3"
	160	161'3"	162'9"	164'11"	167'7"	170'11"	178'11"	188'8"
	170	171'2"	172'8"	174'8"	177'2"	180'3"	187'11"	197'3"
	180	181'1"	182'6"	184'5"	186'10"	189'9"	197'	205'11"
190	191'1"	192'4"	194'2"	196'6"	199'3"	206'2"	214'9"	
200	201'	202'3"	204'	206'2"	208'10"	215'5"	223'7"	

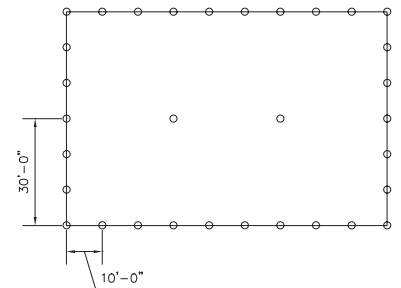
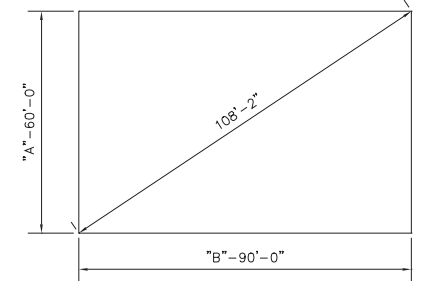
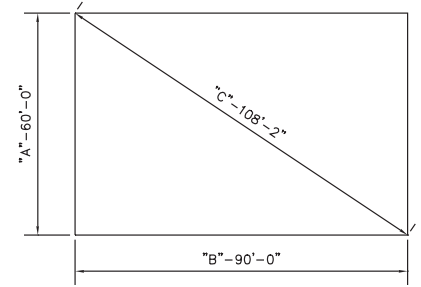

Step 2:

Mark on the ground with chalk or spray paint the location of the leg and center poles. These locations are identified on the drawing to the right. All legs are spaced 10' on center around the perimeter of the tent. Refer to the diagrams included with this manual for the pole locations for the various sizes.

Step 3:

Mark on the ground the location of each staking bar. The dimensions shown indicate the center of each bar. Each bar is placed equal distance away from each leg as the height of the leg. Note: refer to the included diagrams for proper anchoring recommendations.



Step 4:

Drive the anchoring stakes. Place the staking ratchet under the center hole of the staking bar and insert the 1" x 42" double headed stake through both holes. Drive the stake with a sledge hammer, air hammer, or gas powered hammer completely into the ground until it makes contact with the staking bar. Continue driving the outer two stakes through the staking bar into the ground. Continue with all stakes.



The final anchored product will look like the picture shown to the right.



Step 5:

Layout a ground cloth over the ground in the tent area. This will protect the tent top fabric. Position all of the centerpoles on top of the ground cloth so that the pin of the centerpole lays directly above the mark you made on the ground for the centerpole location. The centerpoles should all lay in the same direction so that the bottom points toward the end of the tent. Begin laying out the tent fabric per the layout diagram on pages 21-23.



Step 6:

Install the 4" round ring located at the top of each tent fabric piece over the top of the centerpole. You may use a small piece of rope to tie the four rings to the centerpole top to prevent them from sliding off during installation and lifting of the centerpoles in step 17.



Step 7:

Begin lacing the tent sections together. See to illustration to the right for proper lacing technique.

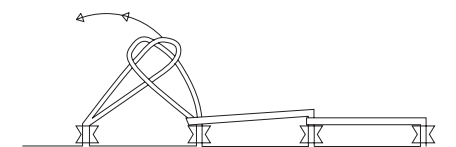

Step 8:

Proper lacing technique shown to the right, using both hands to push the lace of the under panel through the grommet of the upper panel and pulling down to the next set of grommet and lace.



Step 9:

When you come to the end of the lace line the lace is terminated with a double knot as shown to the right.



Step 10:

Now seal the rain flap over the lace connection. Be sure to lay the velcro flap flat and smoothly join the velcro connection so that there are not bumps and that the velcro has full strength to join to the other section.



Step 11:

Connect snaps along perimeter webbing and (on twin pole models) connect the hooks and rings at the center of each middle section.



Step 12:

Begin installing the legs of the tent. First insert the pin of the corner leg pole through the ring on the corner of the tent. Attach three (3) web guys to the leader rings on the corner connection and apply enough tension with the ratchet to make the leg almost vertical.

Step 13:

Continue down the length of the tent installing legs and lightly tensioning the web guys. Continue with the other long side of the tent, starting at the corner and working down the tent.



Step 14:

Proper tensioning technique shown with socket wrench (not included) to apply enough tension to the leg pole to keep it from falling over.



Step 15:

Photo showing all of the leg poles installed and moderately tensioned.



Step 16:

Starting with the first centerpole on the end of the tent slide a 1" x 42" stake through the hole approximately 36" up from the bottom of the centerpole and set stake on the forks of a forklift as shown. Laborers will need to access the top of the centerpole by pushing up the fabric and walking toward the top of the centerpole. Using manpower the top of the centerpole is lifted vertically as the forklift gently moves forward. Once the pole is supported by the lift and the tension of the fabric is holding it off the ground the laborers should move away from the centerpole as the lift continues to slowly move forward.



CAUTION: The top of the centerpole is surrounded by an excess of fabric when it low to the ground. Be very careful that the fabric on the outside of the tent does not catch on the centerpole pin. A spotter is highly recommended to solely watch the pin and fabric from the outside and make any adjustments necessary to free the caught fabric.



Step 17:

Use the lift to position the bottom of the centerpole directly on the mark on the ground that you previously made. As you raise the first centerpole the next centerpole will lift slightly off the ground from tension of the tent fabric. Be sure as the adjoining centerpoles begin to raise they do not fall out of the rings.



Photo to the right shows “spotter” watching and assisting the positioning of the centerpoles from the outside. Be certain to wear proper harness and restraint system.



Step 18:

As the centerpoles are raised you might need to loosen some of the perimeter web guys to avoid overly straining the top fabric during the installation of the centerpoles. To release tension on the ratchet depress the gold colored toggle on the top of the ratchet mechanism with your boot or by gently tapping it with a stake.



Step 19:

Once all the centerpoles are installed you can begin to straighten all of the legs and tensioning all of the ratchet straps. Start with the four (4) corner legs first, make sure they are positioned on the ground mark and then re-tension the web guys so that the leg is plumb. Continue working down both sides of the tent to straighten the legs and tensioning to plumb.

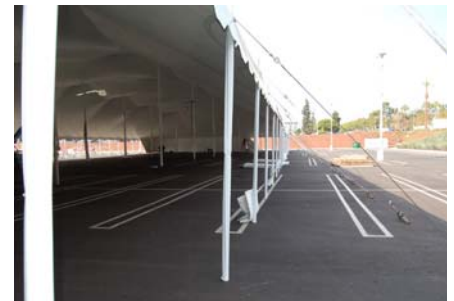

Step 20:

Photo of the fully tensioned Series 2000 Tension Tent.



WARNING: The safe installation and use of commercial tenting products can vary from site to site and during varying climactic conditions. Careful consideration should be paid to any installation during windy conditions. Techniques other than those specified above may be required during these types of conditions.

Soil conditions also vary from site to site. The included anchoring package for this tent may need to be supplemented with alternate anchoring during windy conditions and in areas with questionable soil holding power. Full product engineering is available, but not included, by the manufacturer including structural engineering and site specific soil engineering.

Questions pertaining to the proper procedure for the installation of this and any tent product manufactured by AztecTents should be directed to our design staff at (800) 228-3687.

SERIES 2000 / POLE TENT 40' W x 60' L x 8' LEGS		ENGINEER CM	CHECKED 06/02/06	DATE 06/02/06	REV	0
STANDARD		PART DESCRIPTION		CODE	SIZE	DRAWING NUMBER
AZTEC		490 ALASKA AVE. TORRANCE, CA. 90503 (800) 228-3687 - FAX (310) 381-0722		AZ-40608-S2000		

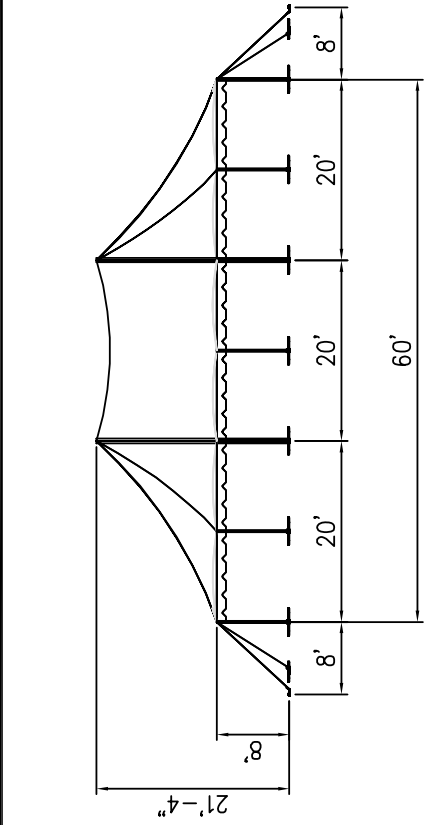

SIDE ELEVATION

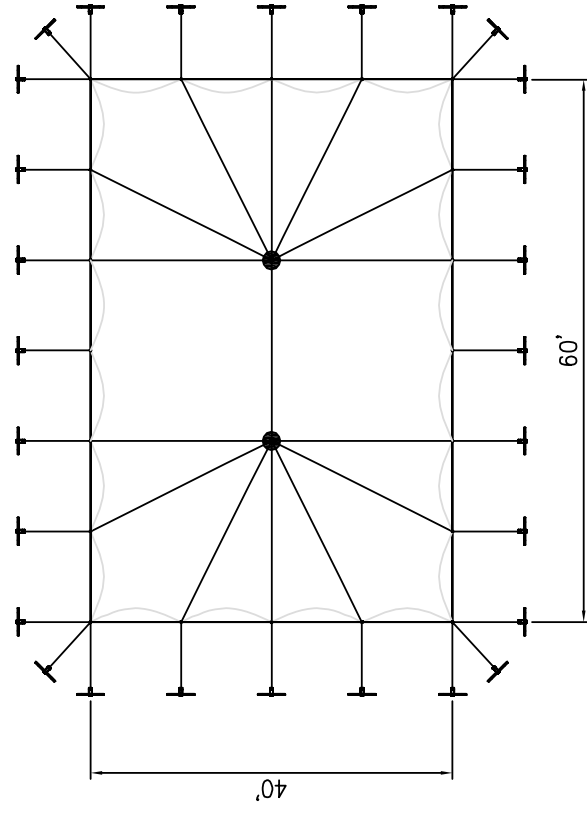

PLAN ELEVATION

● = CENTER POLES NOT TO SCALE

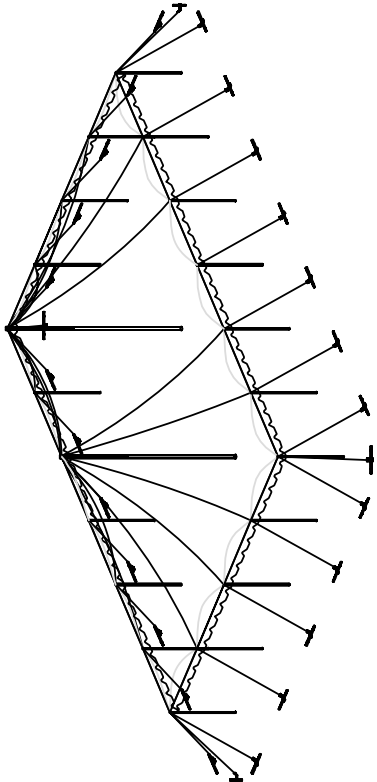

ISOMETRIC ELEVATION

SERIES 2000 TENT
40' x 60' x 8'

- (2) 40' x 20' ENDS
- (1) 40' x 20' MIDDLE
- (2) CENTER POLE
- (20) SIDE POLE
- (28) WEB WINCH
- (28) STAKE BARS
- (84) STAKES

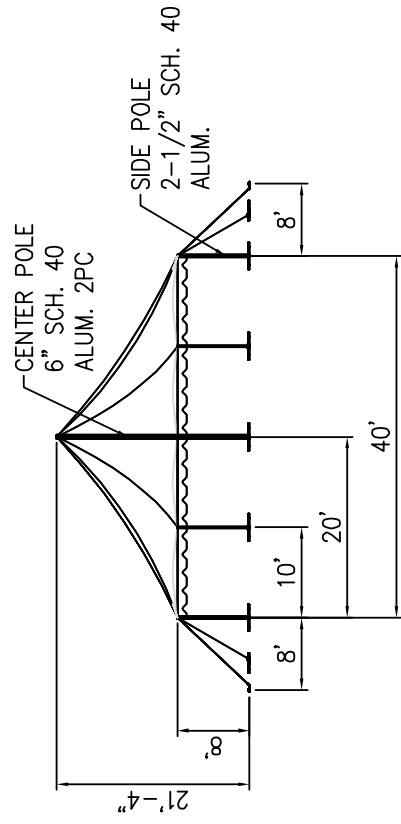

FRONT ELEVATION

SERIES 2000 SINGLE POLE 50'x70'x10'		053006 1235	CHECKED	-	DATE 05/30/06
ENGINEER		CM	DATE	05/30/06	
DRAWN		KT	REV		
PART DESCRIPTION		CODE	SIZE	DRAWING NUMBER	
SERIES 2000 / POLE TENT			50'W x 70'L x 10' LEGS	AZ507010-S2000	
STANDARD					

ALL DATA AND INFORMATION CONTAINED IN OR DISCLOSED BY THIS DOCUMENT IS CONFIDENTIAL AND PROPRIETARY INFORMATION OF AZTEC TENTS AND ALL RIGHTS THEREIN ARE EXPRESSLY RESERVED. BY ACCEPTING THIS MATERIAL THE USER AGREES THAT THIS MATERIAL AND INFORMATION CONTAINED HEREIN IS HELD IN CONFIDENCE AND IN PART, AND WILL NOT BE COPIED, REPRODUCED WHOLE OR IN PART, NOR ITS CONTENTS REVEALED IN ANY MANNER TO OTHERS, EXCEPT TO MEET THE SPECIFIC PURPOSE FOR WHICH IT WAS DELIVERED.

AZTEC
 2665 COLUMBIA ST. TORRANCE, CA. 90503
 (800) 228-3687 - FAX (310) 381-0722

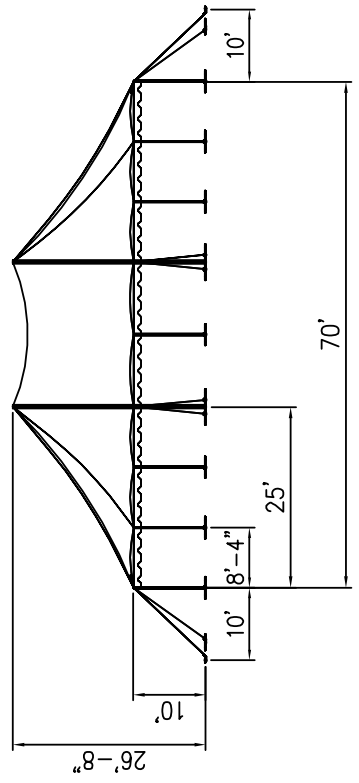

SIDE ELEVATION

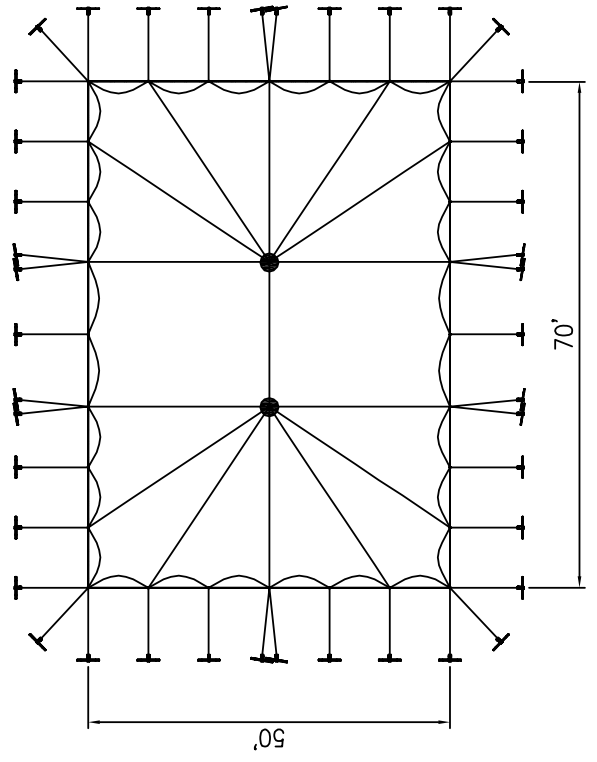

PLAN ELEVATION

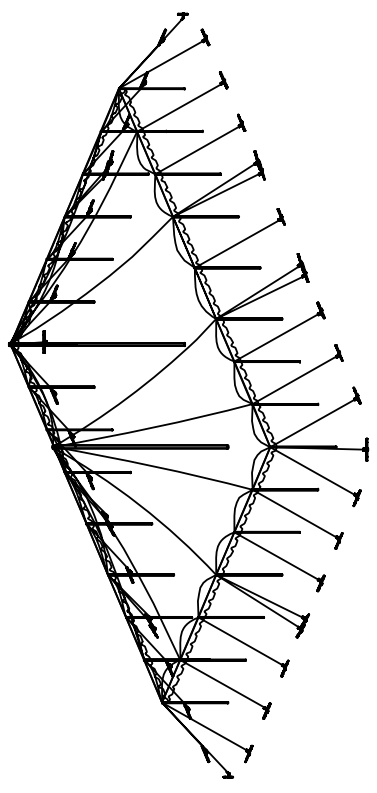

ISOMETRIC ELEVATION

SERIES 2000 TENT
50' x 70' x 10'

- (2) 50' x 25' ENDS
- (1) 50' x 20' MIDDLE
- (2) CENTER POLE
- (28) SIDE POLE
- (42) WEB WINCH
- (42) STAKE BARS
- (126) STAKES

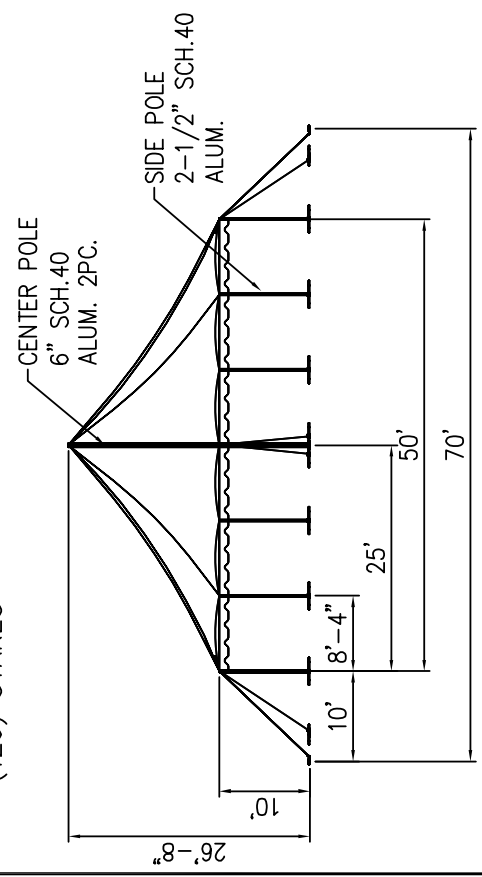

FRONT ELEVATION

SERIES 2000 / POLE TENT 60' W x 120' L x 10' LEGS		DRAWING NUMBER		REV	
AZTECT		ENGINEER CM		CHECKED	
490 ALASKA AVE. TORRANCE, CA. 90503 (800) 228-3687 - FAX (310) 381-0722		DRAWN KT		DATE 05/11/06	
STANDARD		PART DESCRIPTION		CODE	
AZ6012010-S2000		SIZE		REV	

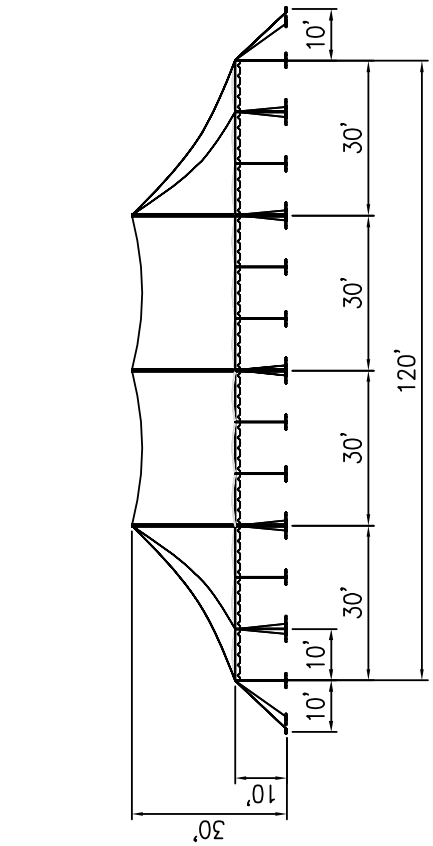

SIDE ELEVATION

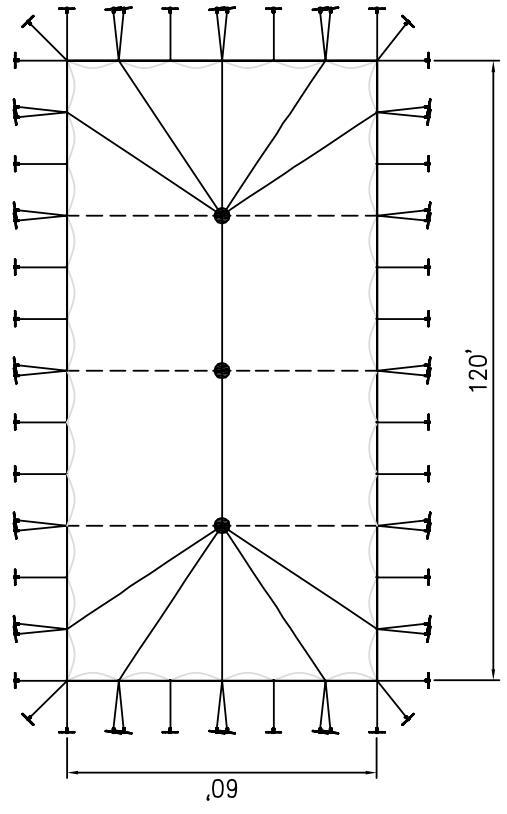

PLAN ELEVATION

● = CENTER POLES NOT TO SCALE

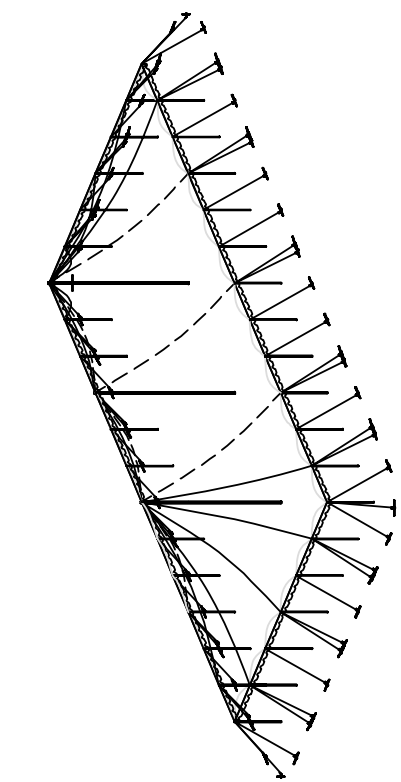

ISOMETRIC ELEVATION

**SERIES 2000 TENT
60' x 120' x 10'**

- (2) 60' x 30' ENDS
- (2) 60' x 30' MIDDLE
- (3) CENTER POLE
- (36) SIDE POLE
- (60) WEB WINCH
- (60) STAKE BARS
- (180) STAKES

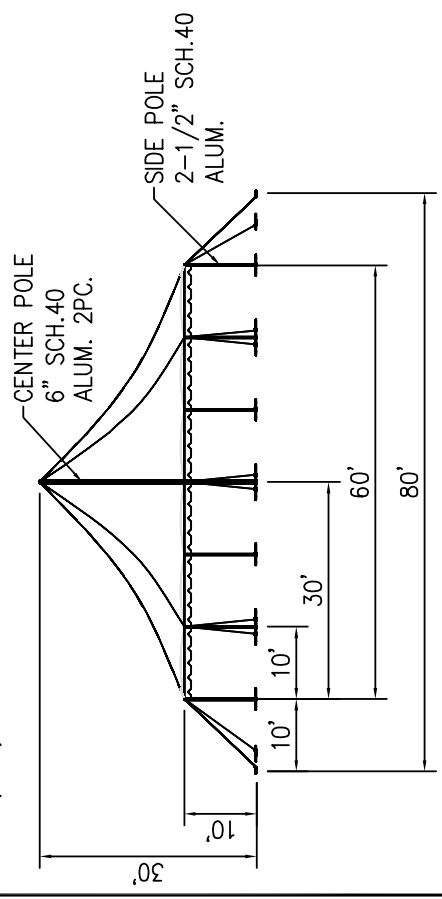

FRONT ELEVATION

ALL DATA AND INFORMATION CONTAINED IN OR DISCLOSED BY THIS DOCUMENT IS CONFIDENTIAL AND PROPRIETARY INFORMATION OF AZTECT TENTS AND ALL RIGHTS THEREIN ARE EXPRESSLY RESERVED. BY ACCEPTING THIS MATERIAL THE RECIPIENT AGREES THAT THIS MATERIAL AND INFORMATION CONTAINED THEREIN IS HELD IN CONFIDENCE AND IN TRUST AND WILL NOT BE COPIED, REPRODUCED WHOLE OR IN PART, NOR ITS CONTENTS REVEALED IN ANY MANNER TO OTHERS. EXCEPT TO MEET THE SPECIFIC PURPOSE FOR WHICH IT WAS DELIVERED.

SERIES 2000 \SINGLEPOLE\60x120x10 051106 1450

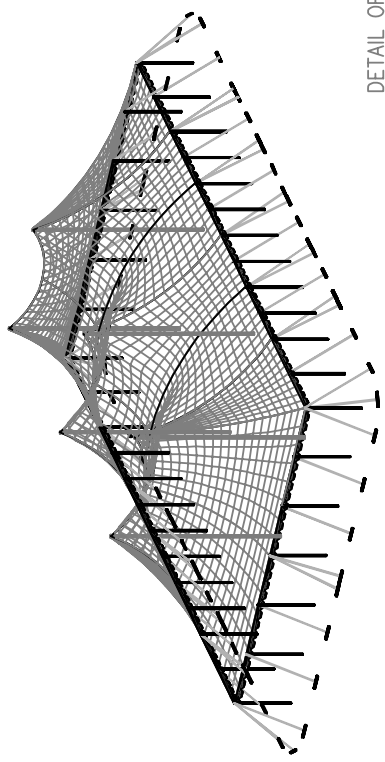

ISOMETRIC ELEVATION

SERIES 2000 TENT
60' x 100' TWIN POLE

- (2) 60' x 20' ENDS
- (2) 60' x 30' MIDDLE
- (6) 6" SCH.40 2PC. CENTER POLE (7'L 27' / 8'L 28' / 10'L 30')
- (36) 2 1/2" SCH. 40 SIDE POLE (7'L / 8'L / 10'L)
- (56) WEB WINCH
- (56) STAKE BARS
- (168) STAKES

FOR ALL SR2000 TENTS

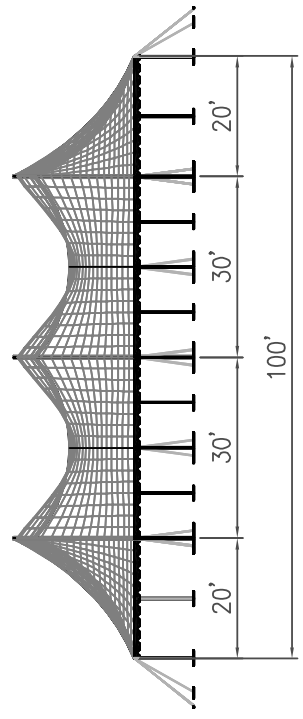
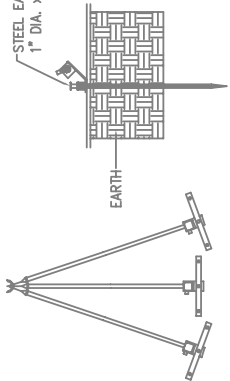

SIDE ELEVATION

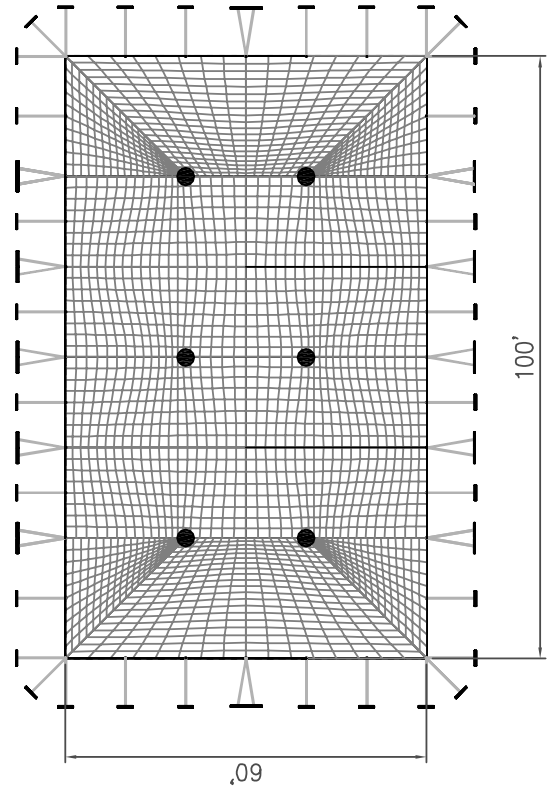

PLAN ELEVATION

● = CENTER POLES NOT TO SCALE

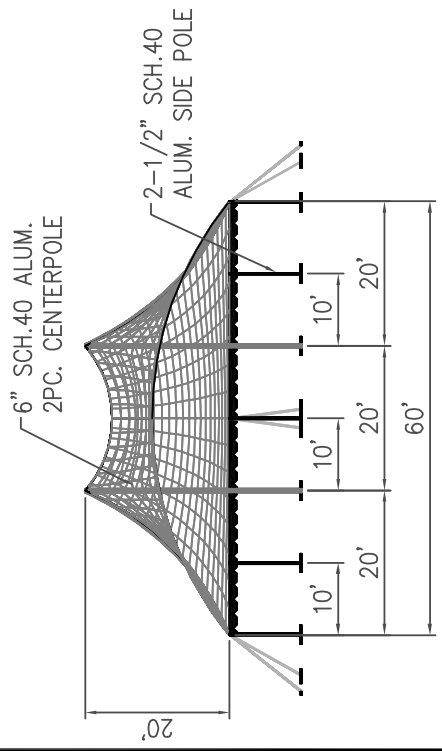

FRONT ELEVATION

		ENGINEER CM DRAWN KT DATE 04/10/07	CHECKED - 042110 1620 SERIES 2000 SINGLE POLE 60x100x30
STANZARD		PART DESCRIPTION 60'W x 100'L x 30' MIDDLES	ALL DATA AND INFORMATION CONTAINED IN OR DISCLOSED BY THIS DOCUMENT IS CONFIDENTIAL AND PROPRIETARY. THE RECIPIENT AGREES THAT THIS MATERIAL AND INFORMATION ARE EXPRESSLY RESERVED. BY ACCEPTING THIS MATERIAL AND INFORMATION OF AZTEC TENTS AND ALL RIGHTS THEREIN CONTAINED HEREIN IS HELD IN CONFIDENCE AND IN TRUST FOR THE RECIPIENT'S USE ONLY. NO PART OF THIS DOCUMENT OR ITS CONTENTS REVEALED IN ANY MANNER TO OTHERS, NOR WILL NOT BE COPIED, REPRODUCED WHOLE OR IN PART, EXCEPT TO MEET THE SPECIFIC PURPOSE FOR WHICH IT WAS DELIVERED.
REV DRAWING NUMBER AZ60100-S2000 3	CODE SIZE S2000	PART DESCRIPTION 60'W x 100'L x 30' MIDDLES	2665 COLUMBIA ST. TORRANCE, CA. 90503 (909) 228-3687 - FAX (310) 381-0722

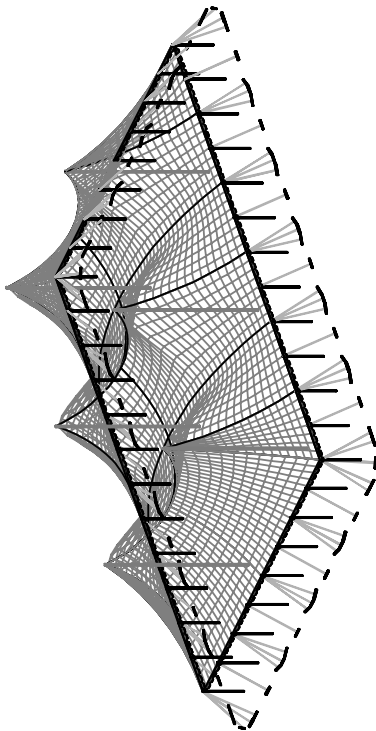

ISOMETRIC ELEVATION

SERIES 2000 TENT
80' x 120' x 10'

- (2) 80' x 20' ENDS
- (2) 80' x 40' MIDDLE
- (6) CENTER POLE
- (40) SIDE POLE
- (88) WEB WINCH
- (88) STAKE BARS
- (264) STAKES

DETAIL OF STAKE BAR ASSEMBLY

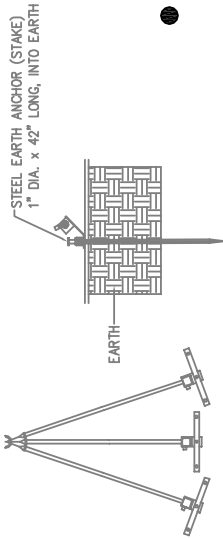

FOR ALL SR2000 TENTS

● = CENTER POLES NOT TO SCALE

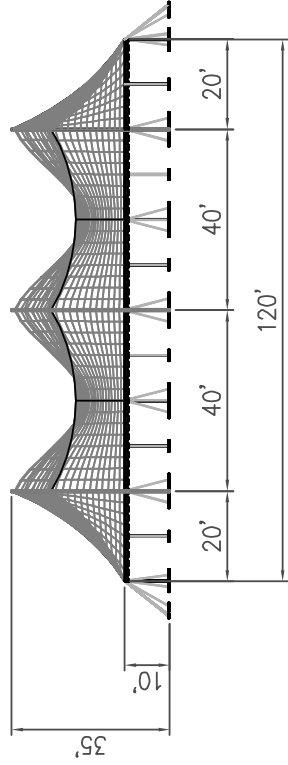

SIDE ELEVATION

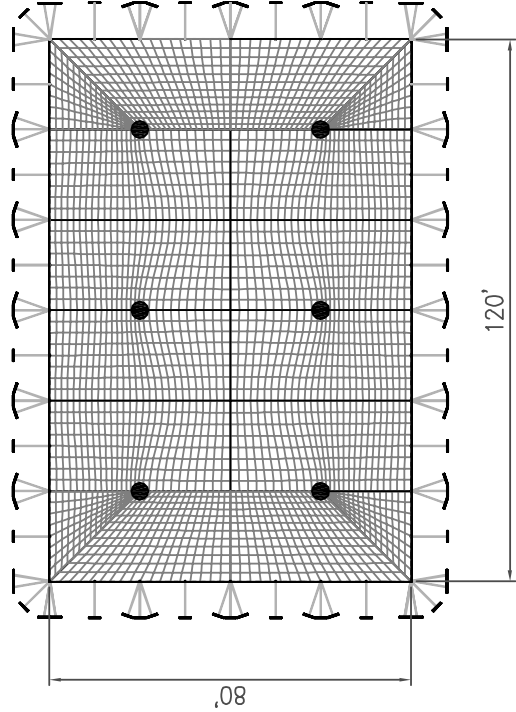

PLAN ELEVATION

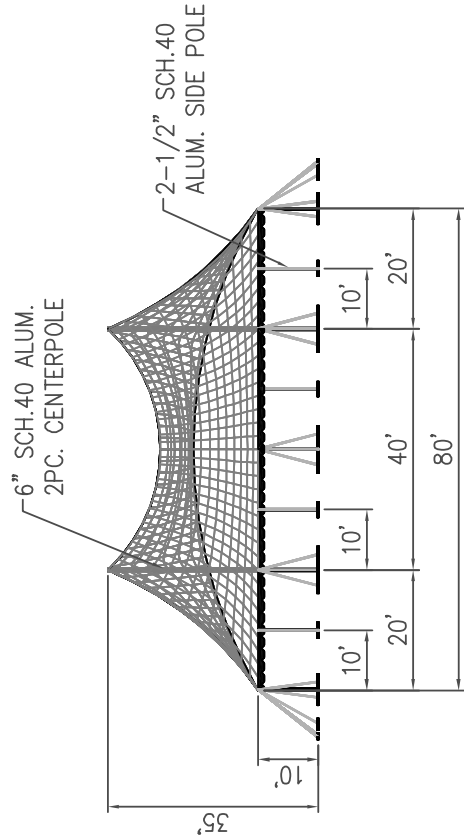

FRONT ELEVATION

SERIES 2000 / POLETENT 80'W x 120'L x 10' LEGS		ENGINEER CM	CHECKED -	DATE 11/30/06	SERIES 2000 \TWINPOLE\80x120x10 062508 1420
PART DESCRIPTION		DRAWN KT	AZTEC 2665 COLUMBIA ST. TORRANCE, CA. 90503 (800) 228-3687 - FAX (310) 381-0722		ALL DATA AND INFORMATION CONTAINED IN OR DISCLOSED BY THIS DOCUMENT IS CONFIDENTIAL AND PROPRIETARY. INFORMATION OF AZTEC TENTS AND ALL RIGHTS THEREIN ARE EXPRESSLY RESERVED. BY ACCEPTING THIS MATERIAL THE RECIPIENT AGREES THAT THIS MATERIAL AND INFORMATION CONTAINED THEREIN IS HELD IN CONFIDENCE AND IN TRUST AND WILL NOT BE COPIED, REPRODUCED WHOLE OR IN PART, EXCEPT TO MEET THE SPECIFIC PURPOSE FOR WHICH IT WAS DELIVERED.
SIZE	CODE	DRAWING NUMBER			
AZ-8012010-S2000	REV	1			

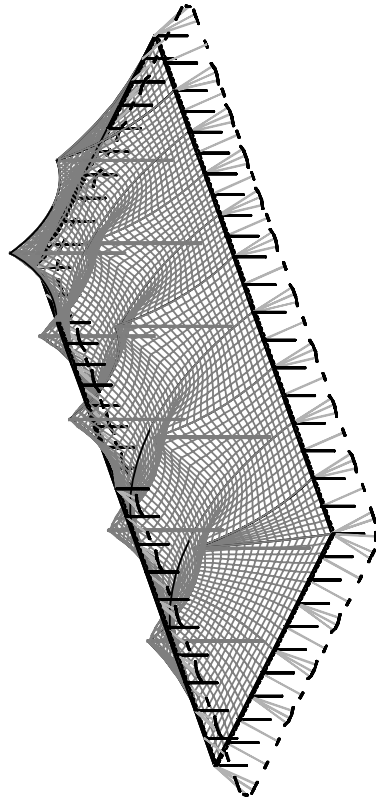

ISOMETRIC ELEVATION

SERIES 2000 TENT
100' x 180' x 10'

- (2) 100' x 20' ENDS
- (2) 100' x 30' MIDDLE
- (2) 100' x 40' MIDDLE
- (10) CENTER POLE
- (60) SIDE POLE
- (124) WEB WINCH
- (124) STAKE BARS
- (372) STAKES

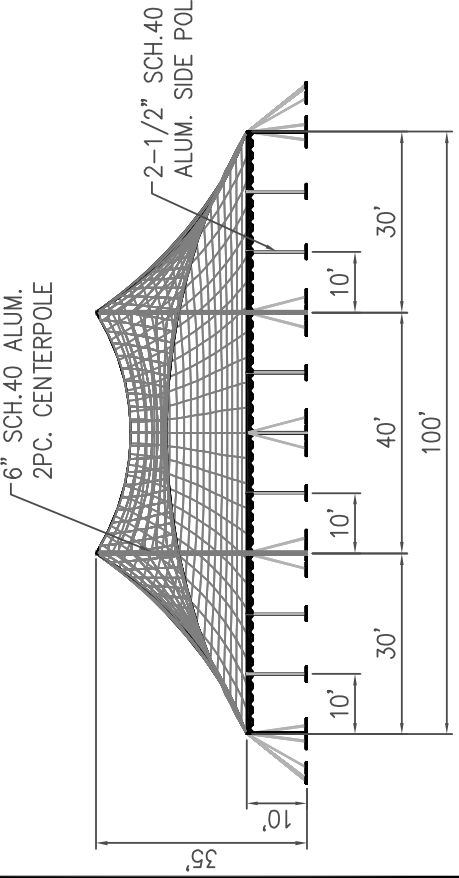

FRONT ELEVATION

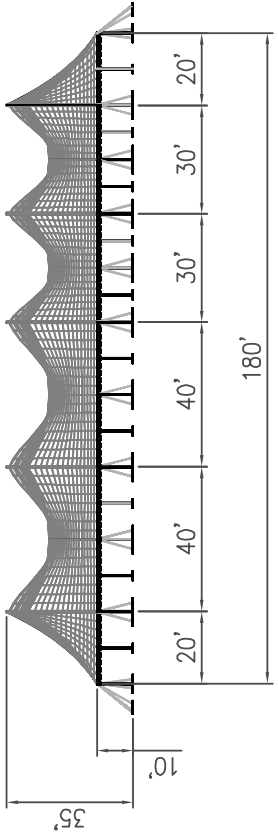

SIDE ELEVATION

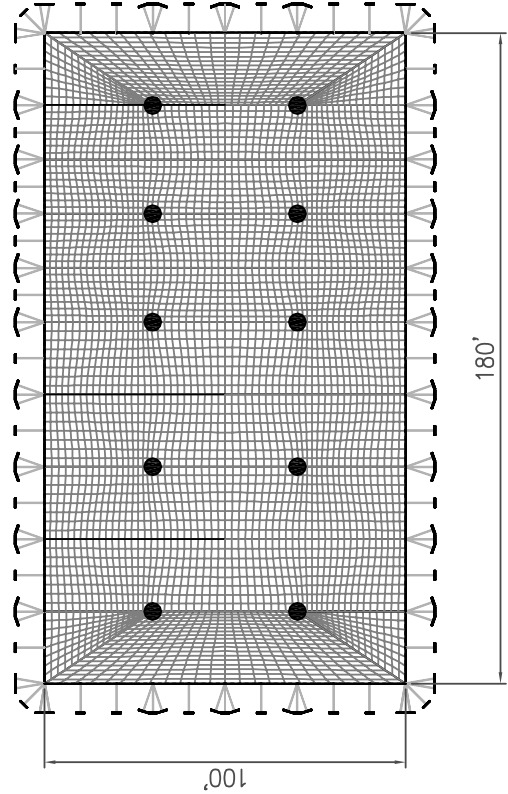

PLAN ELEVATION

● = CENTER POLES NOT TO SCALE

SERIES 2000 / POLE TENT 100' W x 180' L x 10' LEGS		DRAWN CM		DATE 04/12/07	ENGINEER ZTEC	490 ALASKA AVE. TORRANCE, CA. 90503 (800) 228-3687 - FAX (310) 381-0722	ALL DATA AND INFORMATION CONTAINED IN OR DISCLOSED BY THIS DOCUMENT IS CONFIDENTIAL AND PROPRIETARY INFORMATION OF AZTEC TENTS AND ALL RIGHTS THEREIN ARE EXPRESSLY RESERVED. BY ACCEPTING THIS MATERIAL THE RECIPIENT AGREES THAT THIS MATERIAL AND INFORMATION CONTAINED HEREIN IS HELD IN CONFIDENCE AND IN TRUST. AND WILL NOT BE COPIED, REPRODUCED WHOLE OR IN PART, NOR ITS CONTENTS REVEALED IN ANY MANNER TO OTHERS. EXCEPT TO MEET THE SPECIFIC PURPOSE FOR WHICH IT WAS DELIVERED.
REV	DRAWING NUMBER	CODE	SIZE	PART DESCRIPTION	ENGINEER	CHECKED	SERIES 2000\SINGLEPOLE\100x180x10 041207 1150
0	AZ-10018010-S2000						

AZ-120180-S2000 1		DRAWING NUMBER		REV	
AZ-120180-S2000 1		SIZE		CODE	
SERIES 2000 TWIN POLE / STANDARD		PART DESCRIPTION		DRAWN	
120'W x 180'L x 40' MIDDLES		KT		CM	
490 ALASKA AVE. TORRANCE, CA 90503		DATE 12/23/05		CHECKED	
(800) 228-5687 - FAX (310) 381-0722		-		072808 1430	
		ENGINEER (800) 228-5687 - FAX (310) 381-0722		ALL DATA AND INFORMATION CONTAINED IN OR DISCLOSED BY THIS DOCUMENT IS CONFIDENTIAL AND PROPRIETARY INFORMATION OF AZTEC TENTS AND ALL RIGHTS THEREIN ARE EXPRESSLY RESERVED BY ACCEPTING THIS MATERIAL THE RECIPIENT AGREES THAT THIS MATERIAL AND INFORMATION CONTAINED THEREIN IS HELD IN CONFIDENCE AND IN TRUST, AND WILL NOT BE COPIED, REPRODUCED WHOLE OR IN PART, NOR ITS CONTENTS REVEALED IN ANY MANNER TO OTHERS, EXCEPT TO MEET THE SPECIFIC PURPOSE FOR WHICH IT WAS DELIVERED.	

STANDARD

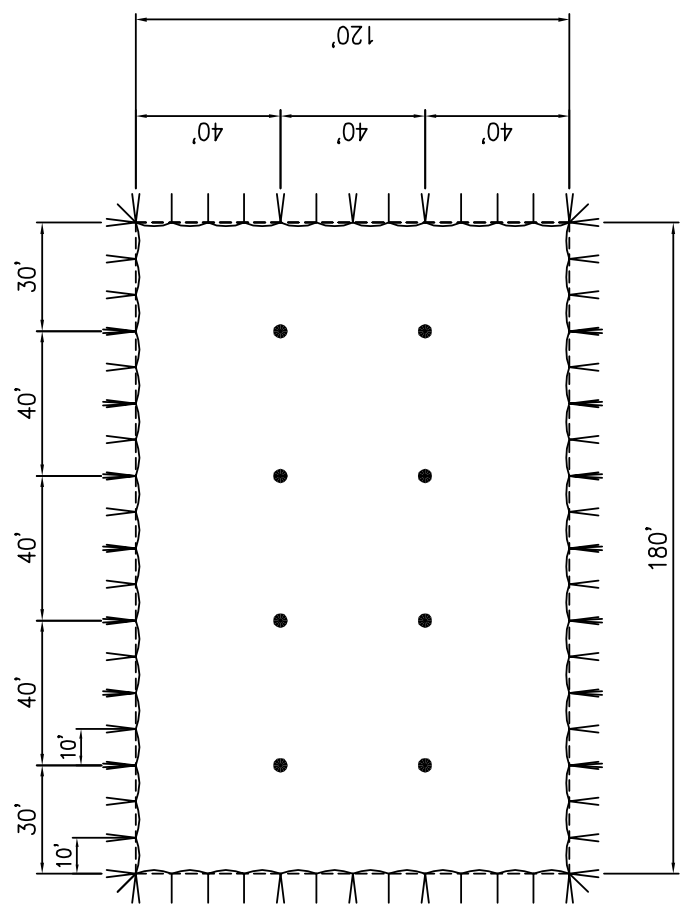
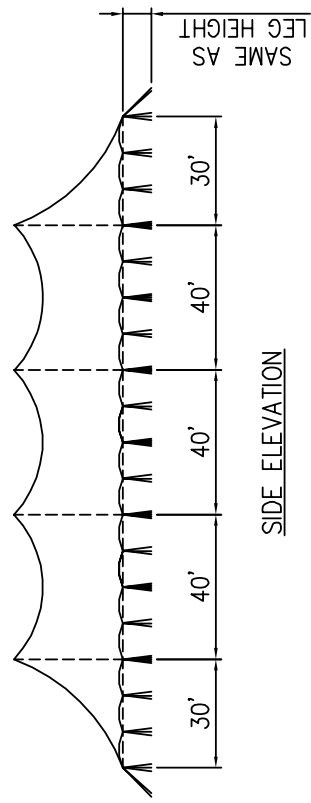
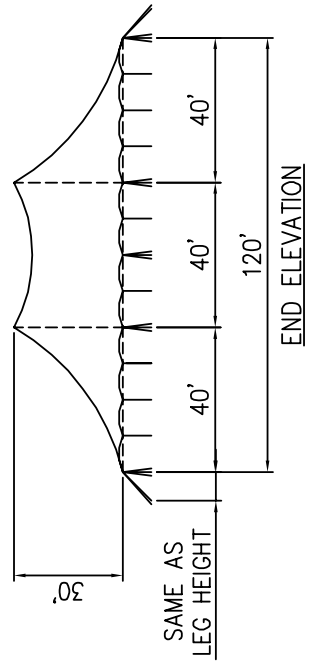

SR 2000 TWIN POLE
120' x 180'

- (2) 30' ENDS (3PC)
- (3) 40' MIDDLES (3PC)
- (8) 8" SCH.40 ALUM. 2PC. CENTER POLE (7'L 37' / 8'L 38' / 10' 40')
- (60) 2-1/2" SCH. 40 SIDE POLE (7'L / 8'L / 10'L)

60-80-100 LEGENDSTAKE DET 070505 1235

ALL DATA AND INFORMATION CONTAINED IN OR DISCLOSED BY THIS DOCUMENT IS CONFIDENTIAL AND PROPRIETARY INFORMATION OF AZTEC TENT AND EVENT INC. AND ALL RIGHTS THEREIN ARE EXPRESSLY RESERVED. BY ACCEPTING THIS MATERIAL, THE RECEPTOR AGREES THAT THIS MATERIAL AND INFORMATION CONTAINED THEREIN IS HELD IN CONFIDENCE AND IN TRUST AND WILL NOT BE COPIED, REPRODUCED WHOLE OR IN PART, NOR ITS CONTENTS REVEALED IN ANY MANNER TO OTHERS, EXCEPT TO FULFILL THE SPECIFIC PURPOSE FOR WHICH IT WAS DELIVERED.

ENGINEER CM
 540 HAWAII AVE. TORRANCE, CA, 90503
 (800) 258-7368 - (310) 328-5060 - FAX (310) 328-5356

DRAWN KT
 DATE 07/05/05

STANDARD

STAKE BAR ASSEMBLY DETAILS

PART DESCRIPTION CODE SIZE DRAWING NUMBER REV

AZ-POLETTENT-DETAILS 0

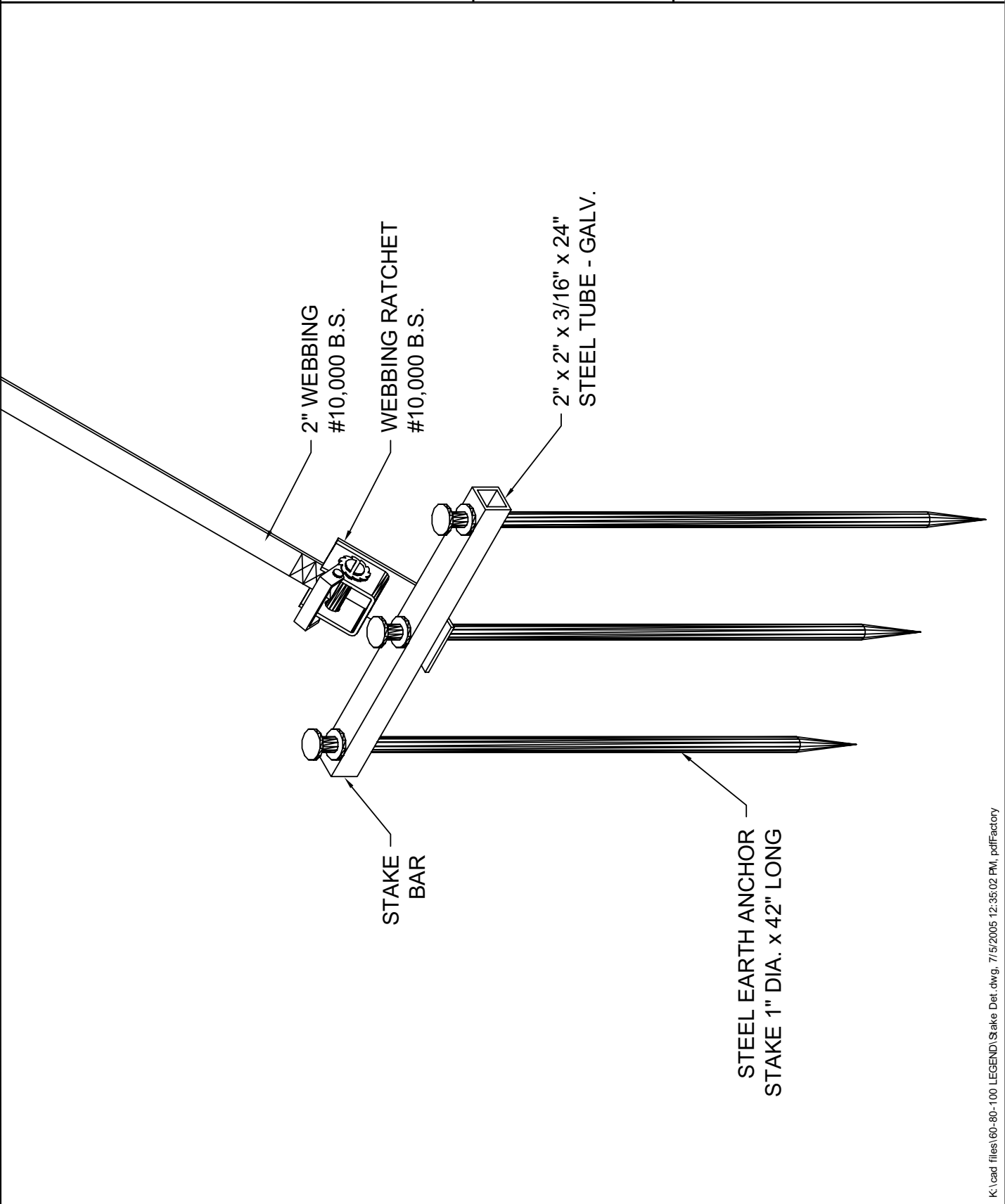

K:\cad files\60-80-100 LEGEND\Stake Det.dwg, 7/5/2005 12:35:02 PM, pdfFactory

Parts Listing

Item	Item No.
*40x20 End Series 2000 SP UW	Z318Z00010B/O
*40x20 Mid Series 2000 SP UW	Z318Z00020B/O
*50x25 End Series 2000 SP UW	Z318Z00030B/O
*50x20 Mid Series 2000 SP UW	Z318Z00040B/O
*60x30 End Series 2000 SP UW	Z318Z00050B/O
*60x20 Mid Series 2000 SP UW	Z318Z00060B/O
*60x30 Mid Series 2000 SP UW	Z318Z00070B/O
*60x20 End S2000 TPLA UW	Z318Z00080B/O
*60x20 End S2000 TPGR UW	Z318Z00090B/O
*60x30 Mid S2000 TP UW	Z318Z00100B/O
*60x40 Mid S2000 TP UW	Z318Z00110B/O
*80x20 End S2000 TPLA UW	Z318Z00120B/O
*80x20 End S2000 TPGR UW	Z318Z00130B/O
*1/2 80x30 Mid S2000 TPLA UW	Z318Z00140B/O
*1/2 80x30 Mid S2000 TPGR UW	Z318Z00150B/O
*1/2 80x40 Mid S2000 TPLA UW	Z318Z00160B/O
*1/2 80x40 Mid S2000 TPGR UW	Z318Z00170B/O
*100x20 End S2000 TPLA UW	Z318Z00180B/O
*100x20 End S2000 TPGR UW	Z318Z00190B/O
*1/2 100x30 Mid S2000 TPLA UW	Z318Z00200B/O
*1/2 100x30 Mid S2000 TPGR UW	Z318Z00210B/O
*1/2 100x40 Mid S2000 TPLA UW	Z318Z00220B/O
*1/2 100x40 Mid S2000 TPGR UW	Z318Z00230B/O
*120x30 End S2000 TPLA UW	Z318Z00240B/O
*120x30 End S2000 TPGR UW	Z318Z00250B/O
*1/2 120x40 Mid S2000 TPLA UW	Z318Z00260B/O
*1/2 120x40 Mid S2000 TPGR UW	Z318Z00270B/O
2.5" SCH40 1pc Alum SP x 7'0"	Z3912.5SCH40X07
2.5" SCH40 1pc Alum SP x 8'0"	Z3912.5SCH40X08
2.5" SCH40 1pc Alum SP x 10'0"	Z3912.5SCH40X10
6" SCH40 1pc S2000 CPx20'4"	Z3946SCH40X2004
6" SCH40 1pc S2000 CPx21'4"	Z3946SCH40X2104
6" SCH40 2pc S2000 CPx23'4"	Z3946SCH40X2304
6" SCH40 2pc S2000 CPx23'8"	Z3946SCH40X2308
6" SCH40 2pc S2000 CPx24'8"	Z3946SCH40X2408
6" SCH40 2pc S2000 CPx26'8"	Z3946SCH40X2608
6" SCH40 2pc S2000 CPx27'0"	Z3946SCH40X27
6" SCH40 2pc S2000 CPx28'0"	Z3946SCH40X28
6" SCH40 2pc S2000 CPx30'0"	Z3946SCH40X30
6" SCH40 2pc S2000 CPx32'0"	Z3946SCH40X32
6" SCH40 2pc S2000 CPx33'0"	Z3946SCH40X33
6" SCH40 2pc S2000 CPx35'0"	Z3946SCH40X35
8" SCH40 2pc S2000 CPx37'0"	Z3948SCH40X37
8" SCH40 2pc S2000 CPx38'0"	Z3948SCH40X38
8" SCH40 2pc S2000 CPx40'0"	Z3948SCH40X40
24" Stake Bar	Z39900300
Tens. Ratchet W/Plate (Only)	Z39900320
2" Web Guy x 20' (Only)	Z39900330
Rolling Skid Plate w/tire Only	Z39900350
Rolling Skid Plate - Base Only	Z39900360
Legend CP Bonnet	Z39900370
5/8" Polydac CP Jumper	Z39900430
5/8" Polydac Leg Jumper	Z39900460



If YOU can IMAGINE it... WE can BUILD it

www.aztectents.com

Aztec Tents
2665 Columbia Street
Torrance, CA 90503
Toll Free (800) 228-3687
Fax (310) 381-0722