

PRODUCT MANUAL



If YOU can IMAGINE it... WE can BUILD it

FESTIVAL®

WARNING

This tent product is not intended to be used as a shelter from severe weather. Evacuate immediately if threatening weather occurs (or is forecasted) or any condition arises concerning the safe use of this product. Threatening weather includes electrical storm systems, moderate to high wind (excess of 38mph), heavy rains, snow, or any condition that raises any doubt to the structural integrity of the tent

CAUTION

The installation of electrical, plumbing, lighting, appliances and/or HVAC equipment are not covered within this manual. Users/Installers shall follow local code requirements for the installation of these items using certified personnel. AztecTents shall be indemnified and held harmless from any such use or injury resulting from its use.

Important Safety Information

Proper personnel safety equipment should be worn at all times during the installation of any tenting products.

Hard Hat

Safety Glasses

Work Gloves

Long Pants

Steel Toe Boots

OSHA Approved Harness and restraint system (for off ground activities)



Thank you for your recent purchase from Aztec Tents. The following procedures will help you through your installation. If you ever run into problems with the installation of your Aztec Tent give one of our sales/service professionals a call. Other product specific information, contact information, diagrams, and other operational support is available on our web site at www.aztectent.com.

Contents

General Care & Guidelines	
General Fabric Care & Maintenance	4
General Hardware Care & Maintenance	5
Fabric Flame Retardant Information	5
Anchoring	5
Pre-Installation Guidelines	6
General Installation Guidelines	6
Post Installation Guidelines- Maintenance	6
Safety & Evacuation Planning	7
General Take Down/Removal Guidelines	7
Special Care for Unsupported Clear Fabric	7
Other Resources	8
Tools Required for Installation	8
Optional Items & Accessories Available	8
Installation Procedure	
10x/15x/20x	9-11
30x	12-16
40x	17-22
Diagrams	23-26
Parts Images	27-28
Engineering Specifications	29-30
Components	31

Questions? Call us.

Aztec Tents

2665 Columbia Street
Torrance, CA 90503 USA
Direct (310) 347-3010
Toll Free (800) 228-3687
Fax (310) 381-0722

General Fabric Care & Maintenance

The vinyl fabric developed for this tent system requires specific attention during installation, cleaning, and storage to maintain its maximum life span. Please follow the following care and maintenance guidelines provided for this product.

GROUND CLOTHS:The usage of ground covering material under the tent during installation and dismantle will protect the tent fabric from soiling and from minor surface abrasions. A ground cloth can also help keep the tent top dry if the ground surface (i.e. dirt, grass, etc.) is wet during the installation or dismantle.

MILDEW TREATMENT:The fabric is pretreated with mildew inhibitors that help prevent the growth and spreading of mildew and fungus. Although treated, proper care should be given to prevent potential growth. If you see mildew wipe it away immediately with a clean towel and diluted soap solution. Never fold your fabric for storage if the fabric is even slightly wet. Mold/Mildew spores in the air and on the ground will come in contact with the fabric while installed. To grow, all the mildew needs is moisture and some source of food (often found in dirt that might be on the tent). Your best bet is to keep your fabric clean and dry to prevent mildew growth.

FABRIC CLEANING:The best way to clean the vinyl tent fabric is with a soft towel or soft bristled brush immersed in a diluted solution of warm water and our tent cleaning solution. A diluted and mixed solution of a tablespoon of traditional dish soap with a gallon of warm water will also work, but extra caution should be placed on insuring that this cleaning solution is thoroughly rinsed from the fabric, especially with clear vinyls (See special notes on working with clear vinyls).

You will need a large, smooth, flat space slightly larger than the section of fabric. This space should be covered with a ground protecting layer to avoid damaging the tent membrane when moving in the washing area. Small impediments, sharp objects and rough surfaces all have the potential to damage the membrane you are trying to clean.

Follow the instructions for the proper dilution ratio of your cleaning product. Apply the diluted solution directly to the fabric using 1) a towel immersed in the solution, or 2) a spray bottle or larger pressurized spraying apparatus to evenly cover the fabric with the solution. Let this sit on the fabric for about one minute to allow the mixture to penetrate the fabric. Using a soft towel or soft bristled polypropylene brush (some can be mounted to a long handle to allow you to stand while working), gently work the cleaner into the fabric using only mild pressure. While harder bristled brushes can work, they will end up microscopically scratching the fabric, potentially permanently damaging the fabric and making it harder to clean the next time. The process of hand cleaning the fabric will allow you to apply only enough diluted solution to get the fabric clean. This will help limit the amount of water placed on the fabric to expedite drying time. Never allow the tent cleaner to dry on the fabric. For this reason, larger tents might be better to clean in sections. Once the cleaning is complete be sure to rinse away any cleaning solution completely from the tent membrane.

Full immersion of the fabric in water is not recommended. The use of commercial front loading or top loading washing machines is not recommended and will void the warranty of the fabric. These machines cause an excessive amount of stress to the fabric and can force water into the fabric causing increased occurrences of mildew growth and shorten the life of the fabric. As with any cleaning, the fabric should be hung to dry completely before folding and storage. Cleaners that include chlorine bleach, and/or any petroleum based solvents will degrade the fabric, discolor the fabric and shorten its life span.

If you have a difficult stain that cannot be removed with traditional cleaning, please consult with your sales person before trying any other chemicals that might end up damaging the material further. Do not use other chemicals or cleaners unless instructed by your sales professional.

FABRIC DRYING:The best way to dry the vinyl tent fabric is to hang-dry in a low humidity environment. Circulating air around the surface of the hanging fabric with the use of fans will also speed the drying process and improve drying time in more humid environments. Please also assure that subassemblies and other components within the tent system are dry before folding. These subassemblies can be reinforcements, lace lines, webbing, rope, thread, and/or any other part that is permanently affixed to the main tent membrane. The use of commercial drying equipment and any drying using heat will void the warranty of the fabric. **DO NOT STORE YOUR FABRIC WET.** Fabric folded and stored wet will mildew.

TENSIONING: Do not over tension your tent fabric during installation, use, or removal. Over tensioning can cause permanent damage to the tent membrane. The most obvious sign of over tensioning would be stress wrinkles at the tension points. Be sure to confirm that your frame/pole components match the tent design. In cases where the ground is not level, over tensioning is possible by trying to force the tent to dimension.

STORAGE RECOMMENDATIONS:The fabric for the tent system shall be stored dry in a cool, dry place in the protective storage bags included with your purchase. Other types of bags are acceptable as long as they can protect the fabric from the environmental elements of the storage area.

INSPECTION: Prior to each use, each component of the tent system needs to be thoroughly inspected to assure its structural stability has not been compromised. Fabric components that are ripped, torn, frayed, or damaged shall be immediately replaced and not used. Structural components of the fabric membrane are the most critical including but not limited to the main fabric membrane, structural reinforcements and webbing, web termination plates/rings/fasteners, and connection points from fabric panel to fabric panel or connection points between the fabric panel and the hardware support system.

General Hardware Care & Maintenance

The hardware components developed for this tent system requires specific attention during installation, cleaning, and storage to maintain its maximum life span. Please follow the following care and maintenance guidelines provided for this product.

OXIDATION:The hardware components for this tent system have been supplied to you with specialty coatings to help limit oxidation. With usage, these coatings will need to be maintained in order to limit oxidation and for the product reach its full intended lifespan. With plated or powder coated steel components, any rust should be removed immediately with a stiff wire brush and sprayed with either a galvanizing spray or durable paint to seal the steel from the elements. Anodized aluminum components will get scratched over time and these scratched areas can develop a thin black oxidation common with mill finish aluminum. This black oxidation can cause staining to any fabric components that come in contact with the pole/component. Your best preventative measure will be to avoid scratching of the anodized coating by avoiding any sharp edges that might be come in contact with the aluminum member.

HARDWARE CLEANING: It is very important to keep your hardware components clean and free of dirt, oxidation, and other chemicals especially if those hardware components come into contact with any fabric components during installation, use, or take-down of your product. Any dirt, oxidation, or chemical on the surface of the hardware member can transfer the contaminant to the fabric causing permanent staining, or permanent damage to the fabric membrane. If hardware components are found to be soiled, wipe down immediately to remove the foreign matter.

STORAGE RECOMMENDATIONS:The hardware for the tent system shall be stored dry in a cool, dry place. Anodized aluminum component can be stored outside, but should be covered to prevent foreign matter from collecting on the components that might stain or damage the fabric membrane during installation or use. Any/all steel components shall be stored indoors in a dry/low humidity environment.

INSPECTION: Prior to and after each use, each component of the tent system needs to be thoroughly inspected to assure its structural stability has not been compromised. Hardware components that are bent, cracked, frayed, or damaged shall be immediately replaced and not used. Specific attention should be paid toward any devices used for anchoring including ratchets, ropes, cables, and web straps.

Fabric Flame Retardancy

All vinyl fabric used in the production of our tents, walls, and accessories are certified flame retardant per per NFPA 701, Canadian CAN-ULC-S109-03, British Standard BS 7837:1996, and are registered with the California State Fire Marshal. These vinyl products are produced so that they are inherently flame retardant, and thus will never require additional applications of flame retardant chemicals.

Every section of fabric produced by Aztec Tents contains a label identifying its flame resistance characteristics and date produced. This label matches a hard copy of the flame certificate that is mailed to you after receipt of your goods.

If at any time you need to be issued a duplicate flame certificate, you can request one from our customer service representatives. Please be sure to have the invoice number and date of production available when requesting duplicate flame certificates.

Anchoring

All anchoring locations must be laid out accurately as described in the manual and diagrams contained within (in advance of laying out the fabric) to a tolerance of +/- 4" in any direction (right or left, forward or back, up or down, etc.) All column base locations must be laid out to a tolerance of +/- 3" in any direction for any standard supported tents and within a tolerance of +/- .5" for any product utilizing keder channels.

A wide variety of ground anchoring devices are commonly used. Soil conditions and resulting ground anchor holding capacities vary from site to site, and can vary within a particular site. The Owner and/or Installer of the tent is fully responsible for assuring that the selection and installation of the anchoring devices is adequate to resist the pull out loads specified in the product manual.

Reduced anchor performance can occur under wet soil conditions and needs to be accounted for. Care should be taken that water is not allowed to drain or collect near anchors.

Anchoring device holding capacity can be developed using a single large device, or by using multiple smaller devices.

Ensure that the anchors installed are adequate to resist the pull out loads shown. Actual testing of some individual anchors to 75% of the anchor pull-out load is recommended.

Additional installation and anchoring information entitled "The IFAI Procedural Handbook For The Safe Installation And Maintenance Of Tentage" is published by the Tent Rental Division of the Industrial Fabric Association International (IFAI).

Pre-Installation Guidelines

Correct field installation of this tent system requires diligence and considerable skill and expertise which can be obtained only through the proper field training and experience of a professional rental tent supervised installation crew. This is instrumental to obtaining the optimal structural behavior of the tent.

- Obtain any required permits or inspections needed by local codes and regulations.
- Clear the site to prepare for the planned activity.
- Check for sub grade utilities before installing any anchoring devices.
- Check for any overhead obstructions that might interfere with the tent installation. Do not install any tent within 50' of any overhead utilities, power lines, or other obstructions. Installation under or within close proximity to trees should be avoided.
- Locate the public circulation routes with clearance from anchors around the exterior of the site. Identify clearly.
- Use drop cloths to prevent soiling or damaging the fabric membrane.
- Pad and tape objects with sharp projections which will remain on site under the tent.
- Cover any sharp edges on anchoring devices with protective material

General Installation Guidelines

Each component of the tent should be inspected at the beginning of installation for visual signs of damage by the installer. All damaged materials should be repaired or replaced immediately.

The weather should be carefully considered by the Owner and/or the Installer before raising the tent since the hardware and fabric cannot transmit design wind loads or shed rainwater loads (potential ponding) when it is not fully anchored, installed, and/or tensioned. It is recommended that installation or removal of the fabric members be performed when the wind speed is less than 15 mph. The decision to raise or lower the fabric of the tent should be the responsibility of the experienced rental tent installation supervisor based upon conservative life safety considerations and judgement.

Adequate and appropriate installation and maintenance procedures are necessary to achieve and sustain full design load capability for the tent. The Owner and/or Installer are fully responsible for assuring that the tent is properly installed and maintained.

Certification of this tent structure is valid only with the use of AztecTent supplied and assured components or those which meet or exceed the requirements of the design throughout the installation of this structure, with the exception of the anchoring devices which must be determined by the installation engineer.

Post Installation Guidelines/ Maintenance

Each component of the tent should be inspected at the end of installation for visual signs of damage by the installer. Additionally, an inspection should be performed after any severe weather/wind events that might have affected the overall integrity of the design. All damaged materials should be repaired or replaced immediately.

A variety of material and weather factors can result in fabric stretch, web belt stretch, rope stretch, mast base settling, changes to design geometry, etc. Changes to the design geometry of the tent and consequently the structural performance characteristics of the tent, can occur while the tent is in service and not attended by the professional installer. It is recommended that a maintenance agreement be arranged between the Client/User of the tent and the Installer involving periodic inspections and adjustments.

If rainwater ponding occurs at any point on the fabric, evacuate the tent, remove the water, and adjust the tie back rope/web prestress tension and/or fabric tensioning over the frame back to its design geometry to achieve positive drainage.

It is understood and expected that some damage to the fabric membrane and/or non structural components may occur in conditions below the overall design wind velocity rating of the tent system. This damage may result in components requiring repair or replacement as necessary.

Safety & Evacuation Planning

It is the responsibility of the Owner and/or the Installer to warn the User and or Occupants of the tent system that this product is not intended to be used as a shelter from severe weather. Aztec assumes no liability for such use. An evacuation and communication plan for the area covered within this tented space is imperative and shall be thoroughly communicated to all users and potential occupants of the tent. Severe weather including electrical storm systems, moderate to severe wind, heavy rains, snow, or any condition that raises any doubt to the structural integrity of the tent are immediate signs that an evacuation is necessary. Severe bodily injury and/or death can occur. A best practices document published by the American Rental Association covering this topic can be downloaded at: http://aztectent.com/webfm_send/151

Common signs that warrant the immediate evacuation of this tent:

- Any movement, displacement, or failure of any of the anchoring devices or support hardware.
- Any component failure in part or whole
- Any tear or puncture in the fabric membrane
- Any forecasted moderate to severe weather condition
- Any collection or accumulation of snow or ice on the tent
- Strong winds causing movement and/shifting of the tent or tent support structure
- Strong winds causing small branches to be ripped from trees
- Any lightning or electrical storms
- Hail or frozen precipitation any larger than pea size
- Any fire or smoke within close proximity of the tent
- Any small amount of gas, exhaust, or other odor from any combustible material

In the event of forecasted severe weather, hurricane, or other such early warning, it is recommended to immediately evacuate the tent and time permitting take down the tent and remove from the site.

General Take Down/ Removal Guidelines

The weather should be carefully considered by the Owner and/or the Installer before lowering the tent since the hardware and fabric cannot transmit design wind loads or shed rainwater loads (potential ponding) when it is not fully anchored, installed, and/or tensioned. It is recommended that installation or removal of the fabric members be performed when the wind speed is less than 15 mph. The decision to raise or lower the fabric of the tent should be the responsibility of the experienced rental tent installation supervisor based upon conservative life safety considerations and judgement.

Unless otherwise noted in the procedures that follow, the removal of this tent system shall follow the same procedures outlined but in the reverse order.

Once unassembled, each component of the system should be inspected for any signs of visual damage by the installer. All damaged materials should be marked or identified so that repair or replacement of these materials can occur prior to the next use of the product.

Special Care For Unsupported Clear Fabric

The clear fabric used in window style sidewalls, clear sidewalls, and clear tent tops needs to be managed differently than standard tent fabric. Polyester scrim is what gives standard tent fabric its strength, stability and durability. Laminated tent fabric enjoys the benefit of encasing this woven layer of rip-stop polyester between the layers of colored vinyl film. Clear vinyl does not enjoy those benefits. Because of this, clear vinyl has a very low tolerance to ultra violet ray exposure, wind, airborne particulate matter, hot or cold temperatures, elasticity due to wind and rain and handling. Any or all of these factors will cause clear fabric to under perform when compared to traditional tent fabric.

Special attention should be paid to the cleaning of these items. Use only the softest towels when cleaning the clear membrane to avoid scratching the highly polished surface, and wipe dry to avoid water spots. Use standard diluted tent cleaning solution. **DO NOT USE OTHER CHEMICALS.**

Exposure to ultra violet rays for an extended amount of time as will occur with time over the life of the product, will cause the fabric to appear milky or opaque. Putting away and storing damp or wet clear vinyl will result in an amber hue in the clear film. Steady wind can whip clear vinyl back and forth and cause surface or through cracks in the fabric. Heat in excess of Eighty-five degrees can cause clear vinyl to change shape, bubble, shrink or stretch. Although our clear vinyl has a cold crack rating of minus fifteen degrees Fahrenheit, that rating is for a static environment. Any introduction of wind or manipulation by handling will cause failure (cracking like glass) at nominal temperatures above freezing. Airborne particulate matter will abrade the surface and cause the finish to become less translucent.

Clear tent tops are also very susceptible to water ponding as they are highly elastic. If rain is forecasted during the use of these products it is recommended to take additional precautions and more frequent inspections throughout the duration of the rainfall to inspect for potential ponding on the roof fabric. If rainwater ponding occurs at any point on the fabric, evacuate the tent, remove the water, and adjust the tie back rope/web prestress tension and/or fabric tensioning over the frame back to its design geometry to achieve positive drainage.

Other Resources

American Rental Association- www.ararental.org

Tent Rental Division of The Industrial Fabric Association International- www.tentexperts.org

Tools Required for Installation

Sledge Hammer	For driving anchoring stakes
Canopy Jacks	For lifting Frame
Drop Cloths	For protecting fabric membrane
Festival Fabric Tool	For pulling corner of vinyl over frame
8' Ladder	General installation tool
Utility Knife	General installation tool
Tape Measure	General installation tool
Marking Paint/Chalk	Used to mark anchoring locations and tent boundaries

Optional Items & Accessories Available

Side Wall Panels	To enclose walls of tent
Raingutters	To collect and divert water away from connecting tent entrances
Decorative Liners	To add decorative look and hide most rafter framework
Double Valance	Makes installation of traditional sidewall and gutters easier
Canopy Doors	To add easily accessible means of egress to and from the tent
Additional Anchors	Additional anchors used to secure the tent system
Colored Flags	Many colors available to customize your event and/or inventory
Graphics	Small logos or full digital print available

Installation Procedure:

10'x/15'x/20'x

Step 1:

Lay out the parts of the tent in place so they are easy to access. See the specific diagram for your size of tent in the pages following the instructions. Connect the perimeter pipes to the corner fittings and use the pins to secure the connection. The perimeter pipe is 9'4" long for the 10x10, 14'4" long for the 15x15, and 19'4" for the 20x20 Festival Frame Tent.

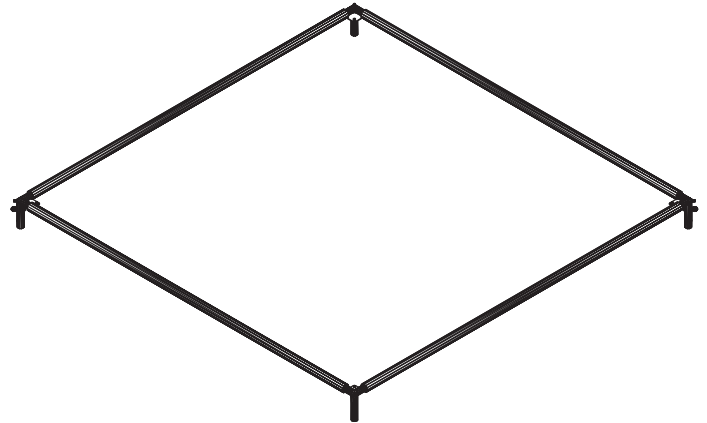

Step 2:

Connect the cables to stretch across to the opposite corner fitting. Start at position one with the cable connected and stretch the cable to corner 2 marked on the diagram to the right. Follow by attaching the other cross cable to corner #3 and pull toward corner #4

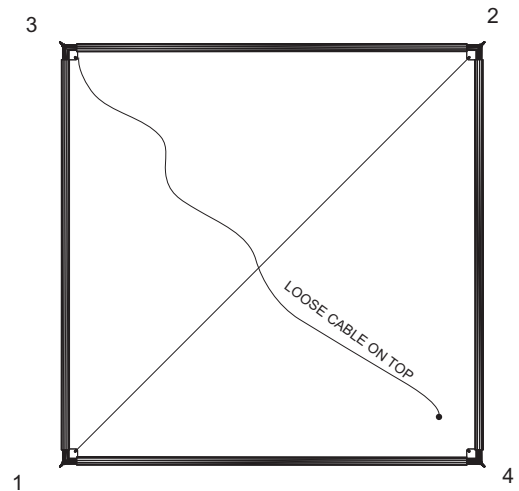

Step 3:

As the cables are made to very exact specifications you will need to lift corner #4 off the ground approximately 24". By lifting this corner you will close the gap and distance between corners 3 and 4 allowing the cable to slip over the support nub on the fitting. When you lower the frame back to the ground the cables will become very tight.



Step 4:

Cover the ground and the cables with a ground cloth. Unfold the tent top and pull over the frame. Each corner of the tent fabric has a thick webbing loop that needs to be pulled tight over the nub on the exterior of the corner fitting.

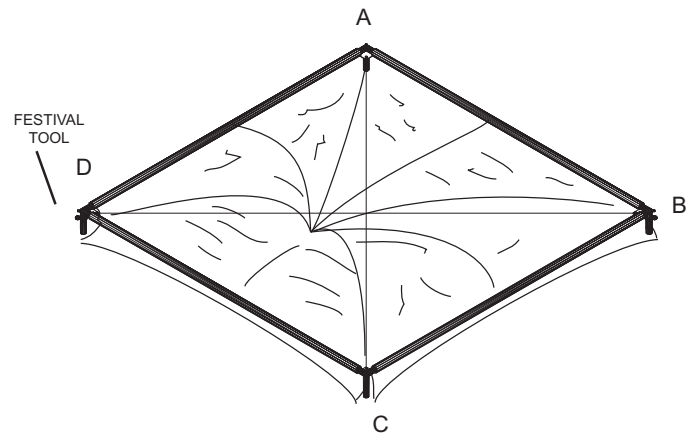

Step 5:

Raise half the tent and install and pin the leg to the corner fittings and connect and pin the baseplate to the bottom of each leg. Before lifting the tent, you may want to anchor the tent to the ground if windy conditions are present. Now that you can gain access under the tent top, slide the pin of the mast through the crown at the peak of the fabric and place the roller wheel on the bottom of the mast on the top cable. Now is the best time to slide the flag on the mast while it is still accessible.

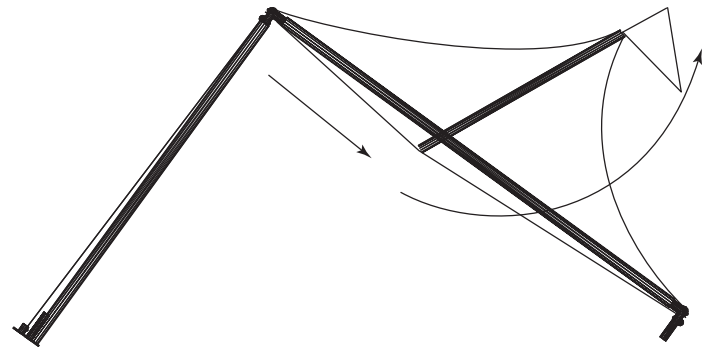

Step 6:

Push the bottom of the mast toward the point where the two cables cross. Once the mast is vertical push the bottom cable down so it snaps into the groove on the bottom mast connection.

Connect the Bottom Mast Caps to the bottom of the mast to secure it.

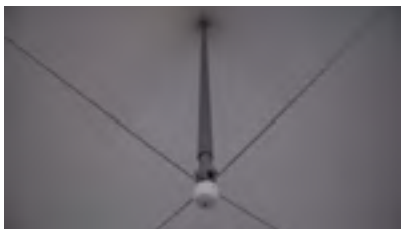

Lift the other side of the tent and install and pin to the corner fittings and baseplate connectors.

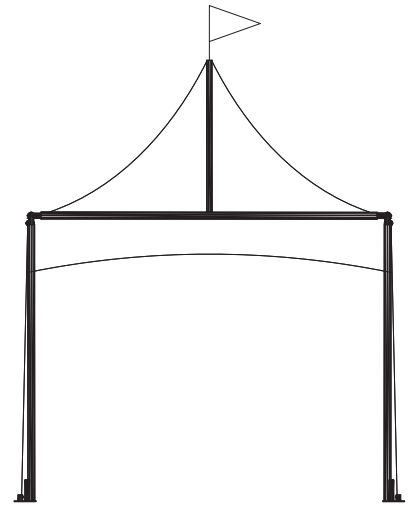

Step 8:

Using the included rope tensioners (10x-15x) connect the spring snap to the ring on the valance tensioning rope. The rope tensioner is designed for use for 7', 8' and 10' legs and therefore a loop needs to be tied at the opposite end to just reach the baseplate. For 20x Festival tops you will use the included ratchet tensioner. Once the tensioner is connected and the loop/ O-ring is over the nub on the Qwik Base Plate you can apply even tension to tighten the valance tensioning system. The 20x Festival tops will also include a midspan tension strap that should be installed with a midspan tensioner at the midpoint of each eave.



Step 9:

For the highest performance in windy conditions you should anchor the baseplates as well as with tie downs installed at a 45 degree angle.

NOTICE

The anchoring devices included with the purchase of this tent will not be suitable for every application or ground condition. It is the installers responsibility to confirm that the anchoring devices used will support the recommended resistance load requirements specified in the appendix of this manual. Additional or different types of anchors may be needed depending on ground conditions.

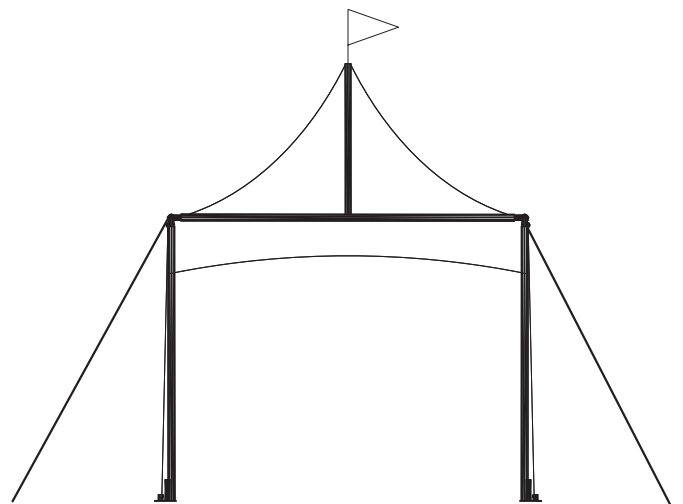

Installation Procedure:

30'x

Step 1:

Assemble (first) square of the "Aerial Mast Sub Frame" which consists of (4) 14'-4" Jumbo Tubes, (2) Festival Intermediate Fittings, (2) Festival Cross Tees, (2) Diagonal Cables and (10) Festival Pins. Assemble and Pin the four sides. Attach diagonal cables. Lift the last corner of the square assembly to enable attachment of cable over last hook. Lay frame down flat on the ground. Assemble (second) square of the "Aerial Mast Sub Frame" to the first square above which adds (3) Jumbo Tubes, (2) Festival Intermediates, (2) Cables and (6) Festival Pins. Assemble and Pin the three additional sides forming (second) square. Attach diagonal cables. Lift last corner (this must be one of two added / untensioned corners) of Square Two assembly to enable attachment of cable over last hook. Lay this added frame down flat on the ground.

Important Note: The bottom diagonal cables must be oriented parallel on all frames with multiple masts.

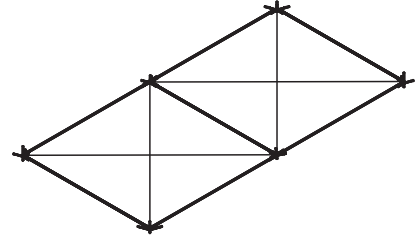

Step 2:

Lift along one of the long sides of the "Aerial Mast Sub Frame" by tipping the "Aerial Mast Sub Frame" up on it's other long side. Place and Pin the Assembly Legs (4'6" pipe) onto the Fitting stubs provided under the Festival Cross Tees and the Festival Intermediates. Lift along the opposite long side by tipping the "Aerial Mast Sub Frame" up on Assembly Legs to place remaining Assembly Legs.

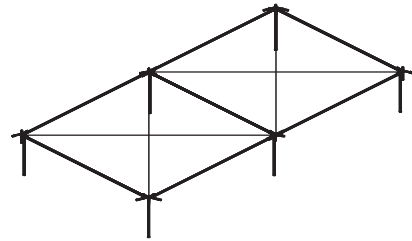

Step 3:

Layout the perimeter fittings around the tent including corner fittings and Jumbo Special Tee Fittings. Starting from one corner of the sub frame connect and pin the three 10'6" hip brace pipes into place. Also connect and pin these pipes to the corner fitting and the Jumbo Special Tee Fittings.

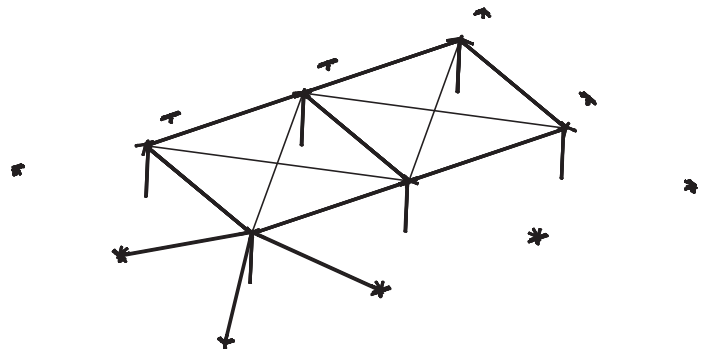

Step 4:

Continue working around the frame from this corner connecting all of the 10'6" brace piping that connects the upper "sub frame" to the perimeter framing. At this time also loop the 30' Cross Cable over the lateral arm of the Jumbo Special Tee Fitting and stretch the cable across the tent to the opposing Jumbo Special Tee Fitting and once again loop over the lateral arm of the opposing Jumbo Special Tee Fitting. Once installed this cable will restrain the frame from spreading past its intended 30' width.

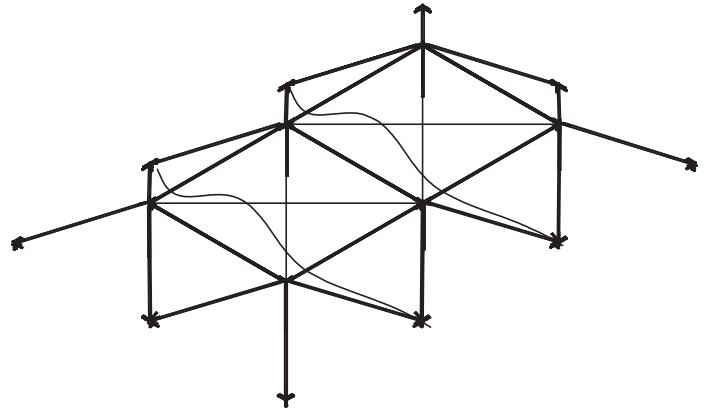

Step 5:

To successfully connect the 30' Cross Cable you will most likely need to lift the frame slightly in the center to relieve the downward pressure of the frame. Once a slight amount of lift is put on the center of the frame the cable will slip over the opposing Jumbo Special Tee Fitting.

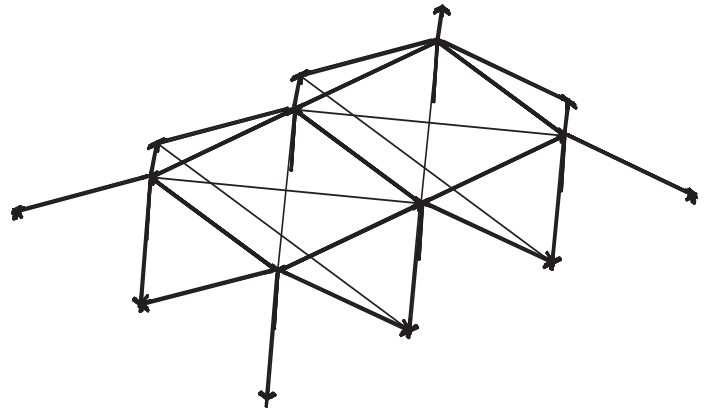

Step 6:

Start at one Jumbo Special Tee Fitting and begin to assemble the perimeter portion of the frame. Ideally, start from the center of each side and work your way connecting and pinning the 14'4" perimeter pipes until you reach the corner.

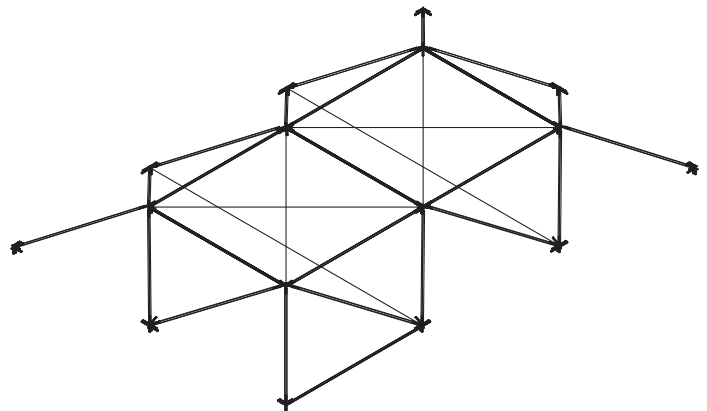

Step 7:

Once your perimeter framing is installed up to the corners, you should un-pin the Corner Fitting connection to the 10'6" Hip brace and slide the Corner Fitting back slightly so you are able to slide on both adjacent 14'4" perimeter pipes and the 10'6" Hip Brace pipe. Once all three pipes are slid over the fitting, you will be easily able to install the pins.

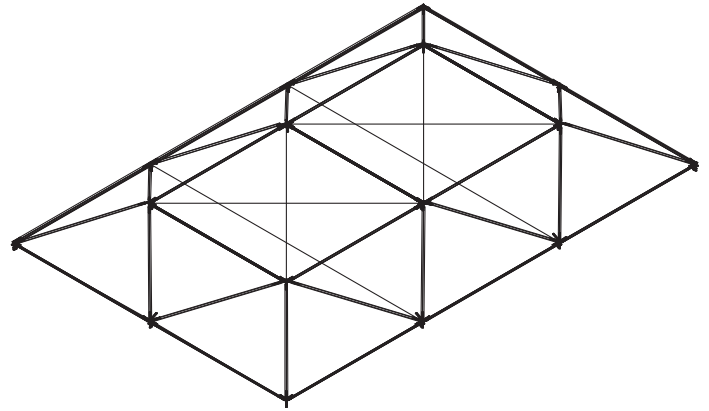

Step 8:

Lay out a ground cloth at this time to prevent damage to the tent top as you unfold it. **Dragging the top fabric on the ground, or pulling hard over frame parts can damage, tear, burn, and scratch the fabric. Be very careful with your fabric.

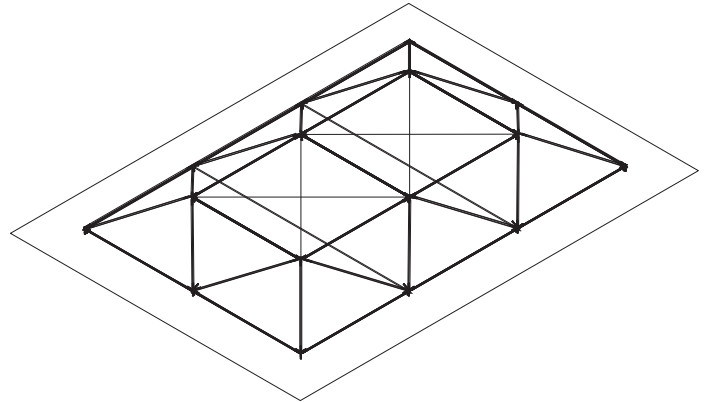

Step 9:

Unfold the tent sections on the drop cloth and carefully pull them over the frame. The Festival tops are available in both 1pc "Fixed" sizes and multiple sectioned expandable sections. If you are using a 1pc "Fixed" top you will want to pull the fabric tight over the frame and secure the festival corner loops over the corner fittings using the festival tool. For expandable top users, please continue to step 10.

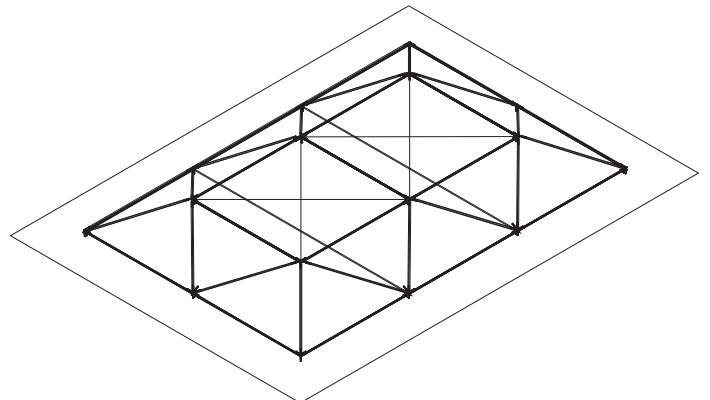

Step 10:

Expandable sections connect to each other with a lace/grommet connection and a Velcro weather flap. Position the multiple sections over the frame. Starting at the peak of the tent, position the two adjoining peak mast fittings together and position the lace side of the connection on the bottom. Pass the lace webbing through the #2 grommet of the connecting section and pull toward the next grommet. Pass the next lace webbing through the next grommet and also pass through the previous lace loop and pull toward the next grommet. Continue lacing the sections until you reach the last lace/grommet where you will need to tie off the lace webbing to itself with a double overhand knot. As you work your way down the lace line be sure to connect the Velcro weather flap to the adjoining section. Repeat with all other lace lines.



Step 11:

Position your tent jacks next to each perimeter fitting along one side of the tent. Once tent jack (sold separately) must be used at each leg to avoid overstressing the frame members. Connect the jacks securely to each perimeter fitting and begin lifting the frame. At this time you need to remove the 4'6" Assembly Legs **At no time should a tent jack be left unmanned. The user must remain in control of the jack to keep from tipping over.

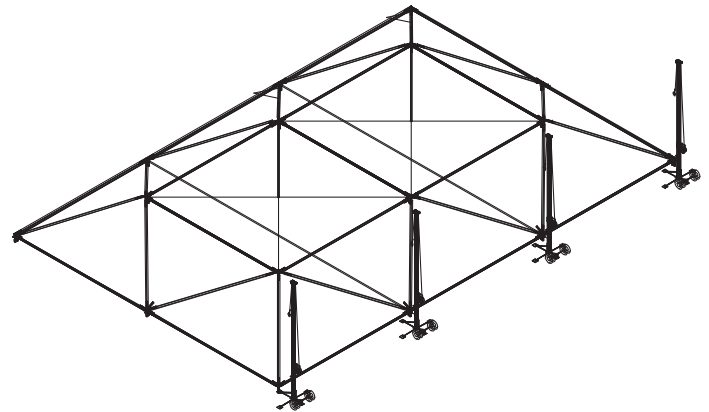

Step 12:

Once the frame is lifted just past the height of the legs you will be able to have a separate crew member slide the leg poles over the fittings and pin into place. Also be sure to install and pin the baseplates at this time. The stake hole and hook should be positioned on the outside of the tent. Lower the frame to sit on the ground. Now that you can gain access under the tent top, slide the pin of the mast through the crown at the peak of the fabric and place the roller wheel (on the bottom of the mast) on the top cable. Push the bottom of the mast toward the point where the two cables cross. Once the mast is vertical push the bottom cable down so it snaps into the groove on the bottom mast connection. Now is the best time to slide the flag on the mast while it is still accessible.

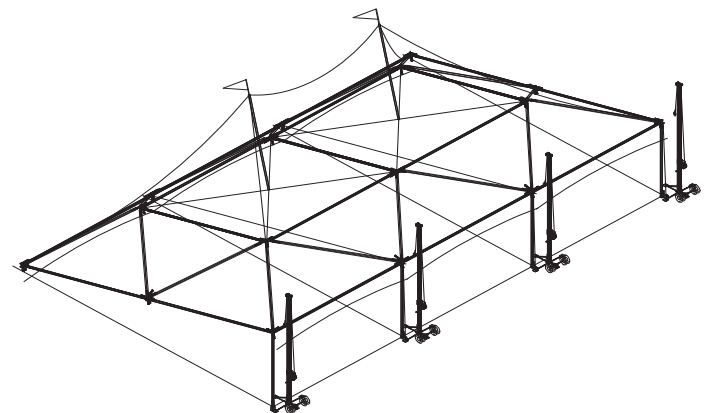

Connect the Bottom Mast Caps to the bottom of the mast to secure it. Continue with other masts.

Step 13:

Reposition the tent jacks to the opposite side of the tent. Secure the jacks to the perimeter fittings and raise the opposite side of the tent just past the height of the leg allowing you to install and pin the leg to the perimeter fitting and the baseplate. At this time also install and pin the legs on the 30' end of the tent.

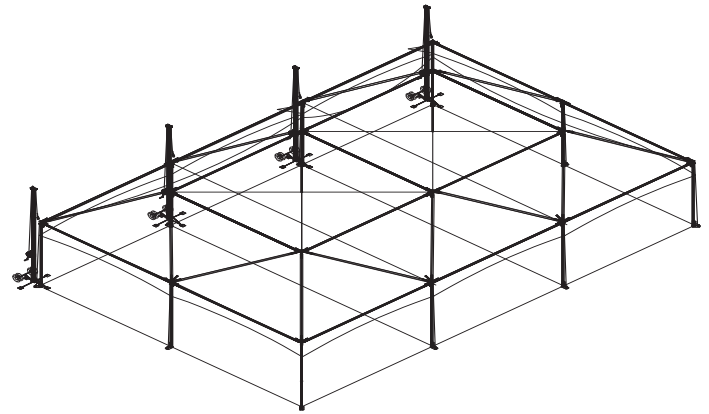

Step 14:

Anchor the tent with the included stakes and 1" In-Line Ratchets. The ratchets should be snapped to the eyebolt at each of the perimeter fittings and preferably the stakes shall be driven through the pear-shaped ring on the In-Line Ratchet. The stakes should be driven straight into the ground at a distance equal to the height of the leg. Once the stakes are driven, engage the ratchets and apply significant tension to the straps.

NOTICE

The anchoring devices included with the purchase of this tent will not be suitable for every application or ground condition. It is the installers responsibility to confirm that the anchoring devices used will support the recommended resistance load requirements specified in the appendix of this manual. Additional or different types of anchors may be needed depending on ground conditions.

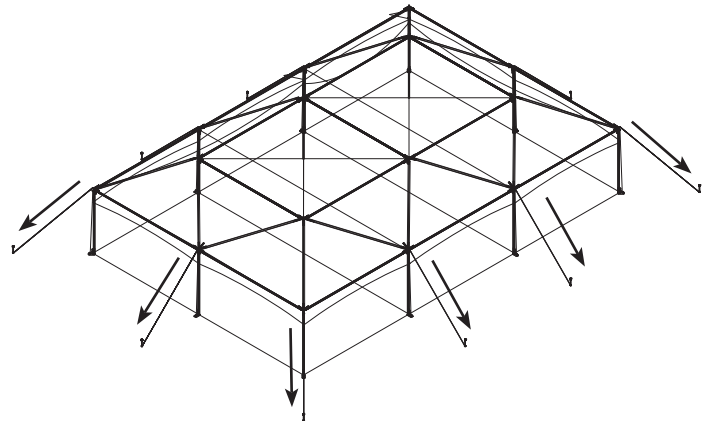

Step 15:

Using the included ratchet tensioners (included in bag with tent tops) connect the 1" narrow hook to the ring on the valance tensioning rope. The ratchet tensioner is designed for use for 8' and 10' legs. Once the spring snap is connected and the loop is over the nub on the Base Plate you can apply even tension to tighten the valance tensioning system.

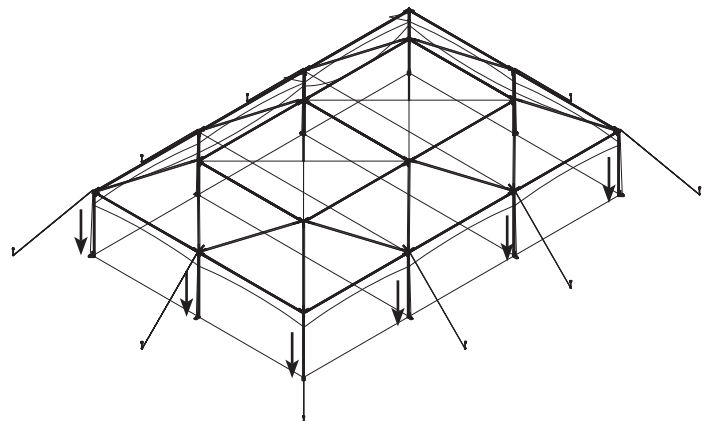

Installation Procedure:

40'x

Step 1:

Assemble (first) square of the "Aerial Mast Sub Frame" which consists of (4) 19'-4" Jumbo Tubes, (2) Festival Intermediate Fittings, (2) Festival CrossTees, (2) Diagonal Cables and (10) Festival Pins. Assemble and Pin the four sides. Attach diagonal cables. Lift the last corner of the square assembly to enable attachment of cable over last hook. Lay frame down flat on the ground. Assemble (second) square of the "Aerial Mast Sub Frame" to the first square above which adds (3) Jumbo Tubes, (2) Festival Intermediates, (2) Cables and (6) Festival Pins. Assemble and Pin the three additional sides forming (second) square. Attach diagonal cables. Lift last corner (this must be one of two added / un-tensioned corners) of Square Two assembly to enable attachment of cable over last hook. Lay this added frame down flat on the ground.

Important Note: The bottom diagonal cables must be oriented parallel on all frames with multiple masts.

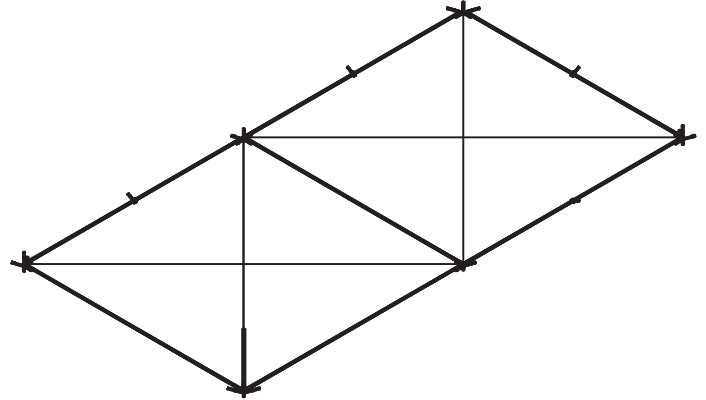

Step 2:

Lift along one of the long sides of the "Aerial Mast Sub Frame" by tipping the "Aerial Mast Sub Frame" up on it's other long side. Place and Pin the Assembly Legs (6'0" pipe) onto the fitting stubs provided under the Festival CrossTees and the Festival Intermediates. Lift along the opposite long side by tipping the "Aerial Mast Sub Frame" up on Assembly Legs to place remaining Assembly Legs.

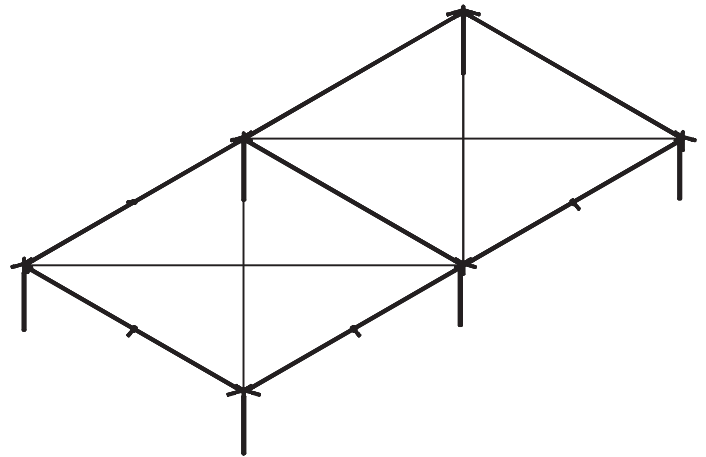

Step 3:

Layout the perimeter fittings around the tent including corner fittings and Jumbo Special Tee Fittings. Starting on the upper sub frame connect and bolt the Jumbo Slide Rafter Fittings at the midpoint of each 19'-4" Jumbo Pipes and connect and pin the 10'-6" brace pipes into place. Also connect and pin these pipes to the Jumbo Special Tee Fittings located on the perimeter.

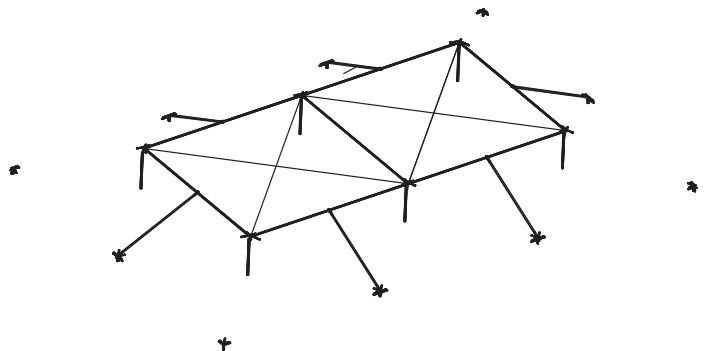

Step 4:
Begin connecting and pinning all of the 14'4" Jumbo pipes around the tent. Always connect and pin to the upper sub frame first and then connect and pin to the perimeter fitting.

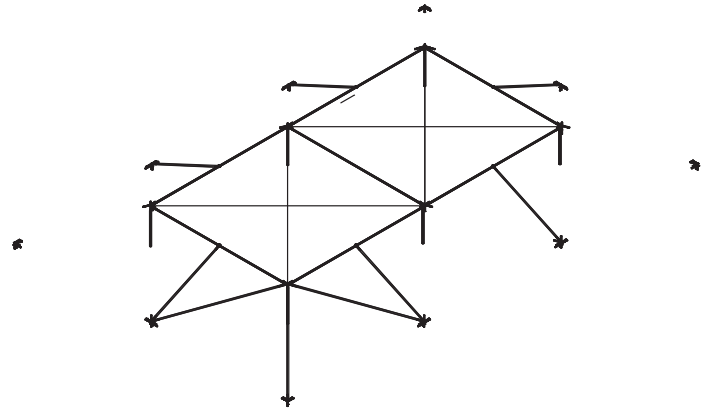

Step 5:
Continue connecting and pinning all of the remaining 14'4" Jumbo support pipes.

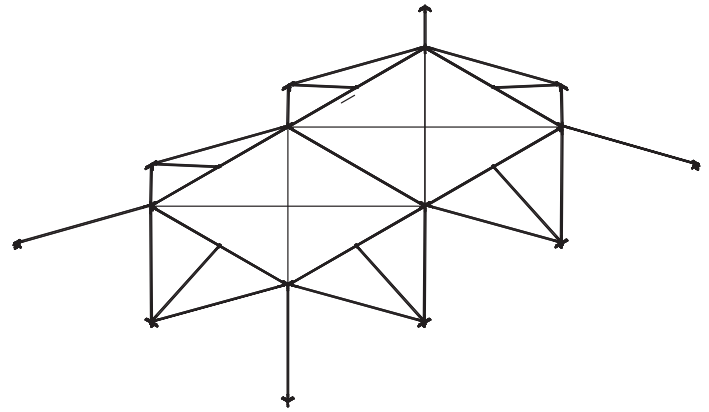

Step 6:
At this time also loop the 40' Cross Cable over the lateral arm of the Jumbo Special Tee Fitting and stretch the cable across the tent to the opposing Jumbo Special Tee Fitting and once again loop over the lateral arm of the opposing Jumbo Special Tee Fitting. Once installed this cable will restrain the frame from spreading past its intended 40' width.

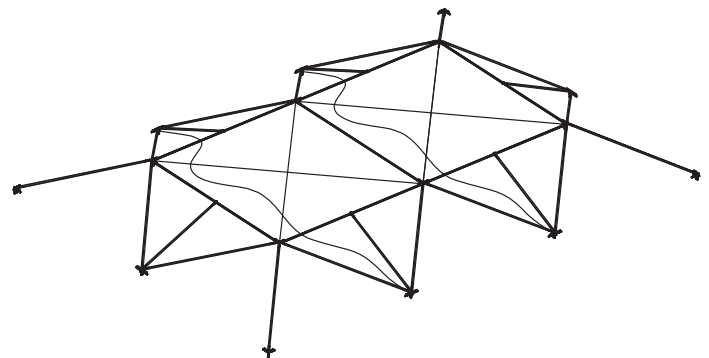

Step 7:

Start at one Jumbo Special Tee Fitting and begin to assemble the perimeter portion of the frame. Ideally, start from the center of each side and work your way connecting and pinning the 19'4" perimeter pipes until you reach the corner.

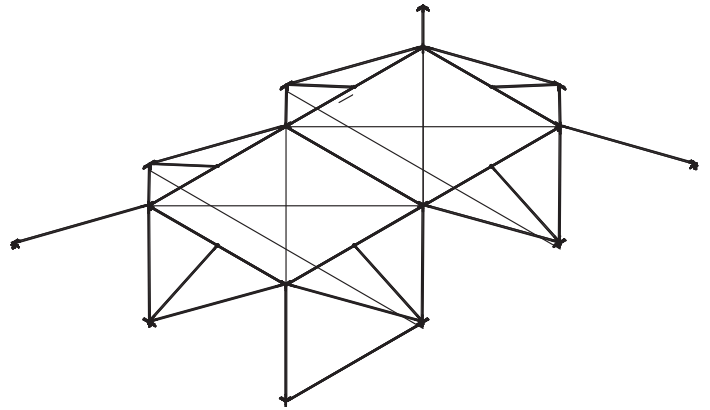

Step 8:

Once your perimeter framing is installed up to the corners, you should un-pin the Corner Fitting connection to the 14'4" Hip brace and slide the Corner Fitting back slightly so you are able to slide on both adjacent 19'4" perimeter pipes and the 14'4" Hip Brace pipe. Once all three pipes are slid over the fitting, you will be easily able to install the pins. Also now install the 40x Festival Jumbo Truss Cable. This cable is only used when you have multiple sub frame extensions (ex. in 40x60's and larger). Attach cables to the Festival Intermediate fittings, install riser pipe and pin to Festival Jumbo Cross Tee and tighten turnbuckle.

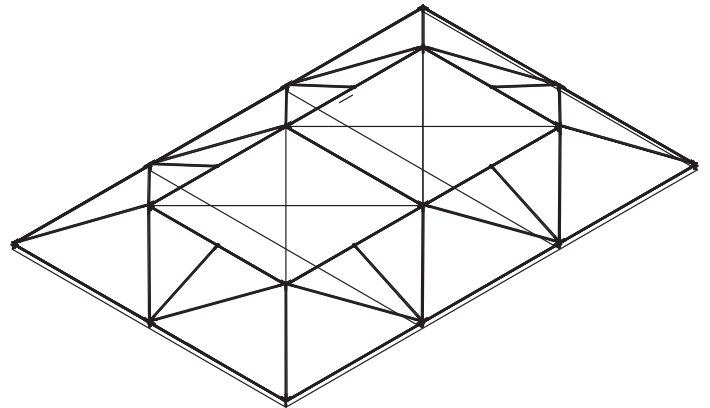

Step 9:

Lay out a ground cloth at this time to prevent damage to the tent top as you unfold it.

****Dragging the top fabric on the ground, or pulling hard over frame parts can damage, tear, burn, and scratch the fabric. Be very careful with your fabric.**

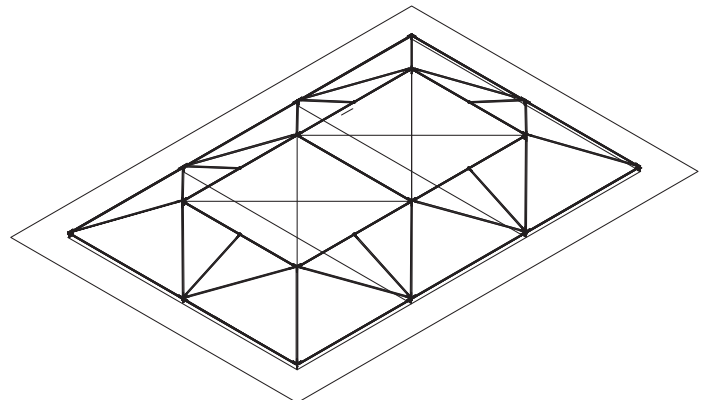

Step 10:

Unfold the tent sections on the drop cloth and carefully pull them over the frame. The Festival tops are available in both 1pc "Fixed" sizes and multiple sectioned expandable sections. If you are using a 1pc "Fixed" top you will want to pull the fabric tight over the frame and secure the festival corner loops over the corner fittings using the Festival tool. For expandable top users, please continue to step 10.

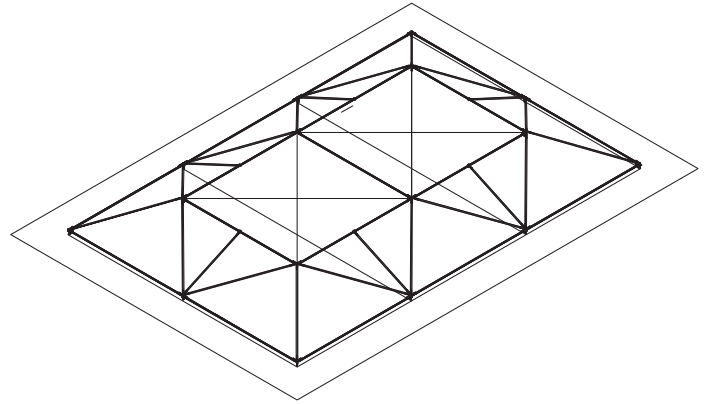

Step 11:

Expandable sections connect to each other with a lace/grommet connection and a Velcro weather flap. Position the multiple sections over the frame. Starting at the peak of the tent, position the two adjoining peak mast fittings together and position the lace side of the connection on the bottom. Pass the lace webbing through the #2 grommet of the connecting section and pull toward the next grommet. Pass the next lace webbing through the next grommet and also pass through the previous lace loop and pull toward the next grommet. Continue lacing the sections until you reach the last lace/grommet where you will need to tie-off the lace webbing to itself with a double overhand knot. As you work your way down the lace line be sure to connect the Velcro weather flap to the adjoining section. Repeat with all other lace lines.



Step 11:

Position your tent jacks next to each perimeter fitting along one side of the tent. Once tent jack (sold separately) must be used at each leg to avoid overstressing the frame members. Connect the jacks securely to each perimeter fitting and begin lifting the frame. At this time you need to remove the 6'0" Assembly Legs

****At no time should a tent jack be left unmanned. The user must remain in control of the jack to keep from tipping over. If windy conditions exist, it is suggested that the frame be anchored to the ground before lifted.**

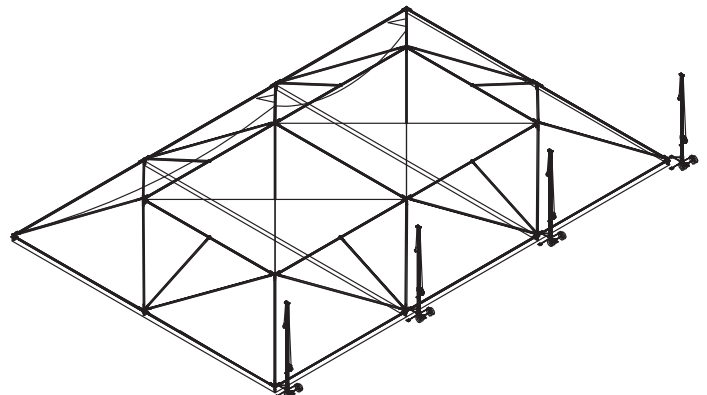

Step 12:

Once the frame is lifted just past the height of the legs you will be able to have a separate crew member slide the leg poles over the fittings and pin into place. Also be sure to install and pin the baseplates at this time. The stake hole and hook should be positioned on the outside of the tent. Lower the frame to sit on the ground.

Now that you can gain access under the tent top, slide the pin of the mast through the crown at the peak of the fabric and place the roller wheel (on the bottom of the mast) on the top cable. Push the bottom of the mast toward the point where the two cables cross. Once the mast is vertical push the bottom cable down so it snaps into the groove on the bottom mast connection. Now is the best time to slide the flag on the mast while it is still accessible.

Connect the Bottom Mast Caps to the bottom of the mast to secure it. Continue with other masts.

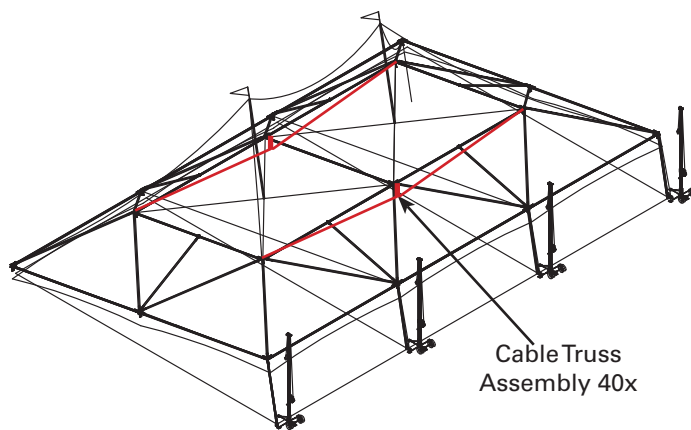

Step 13:

Reposition the tent jacks to the opposite side of the tent. Secure the jacks to the perimeter fittings and raise the opposite side of the tent just past the height of the leg allowing you to install and pin the leg to the perimeter fitting and the baseplate. At this time also install and pin the legs on the 30' end of the tent.

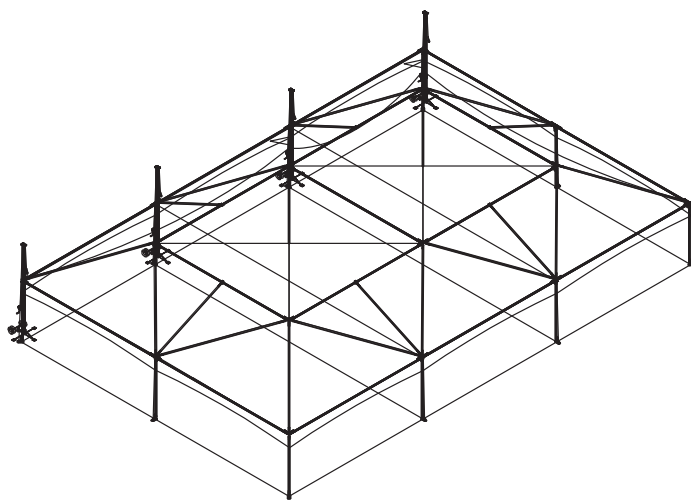

Step 14:

Anchor the tent with the included stakes and 2" In-Line Ratchets. The ratchets should be snapped to the eyebolt at each of the perimeter fittings and preferably the stakes shall be driven through the pear-shaped ring on the In-Line Ratchet. The stakes should be driven straight into the ground at a distance equal to the height of the leg. Once the stakes are driven, engage the ratchets and apply significant tension to the straps.

NOTICE

The anchoring devices included with the purchase of this tent will not be suitable for every application or ground condition. It is the installers responsibility to confirm that the anchoring devices used will support the recommended resistance load requirements specified in the appendix of this manual. Additional or different types of anchors may be needed depending on ground conditions.

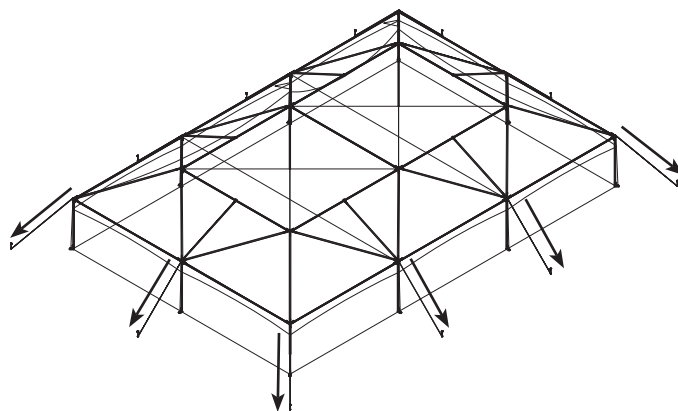

Step 15:

Using the included ratchet tensioners (included in bag with tent tops) connect the 1" narrow hook to the ring on the valance tensioning rope. The ratchet tensioner is designed for use for 8' and 10' legs. Once the spring snap is connected and the loop is over the nub on the Base Plate you can apply even tension to tighten the valance tensioning system. Also install the midspan tensioners at the midpoint of the perimeter pipes to the straps located on the underside of the fabric top.

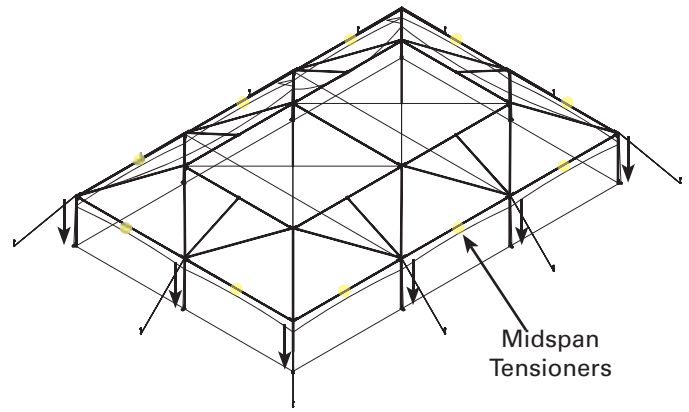

10' WIDE FESTIVAL CONFIGURATION

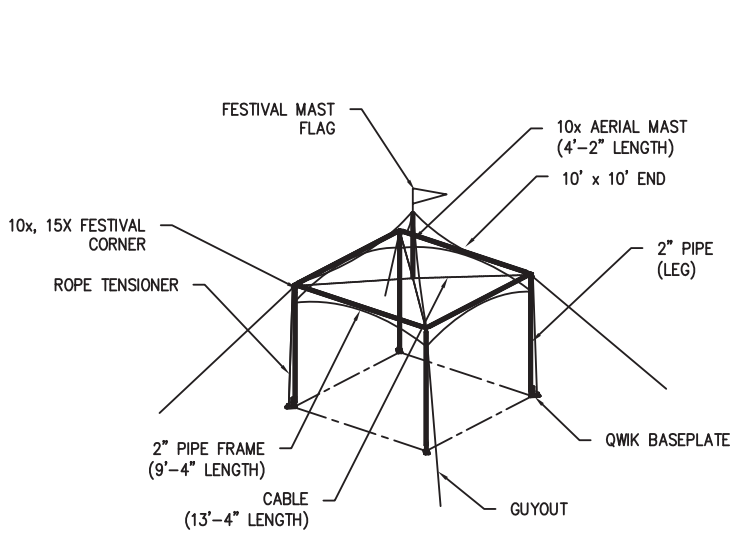

10x10 1PC. FESTIVAL

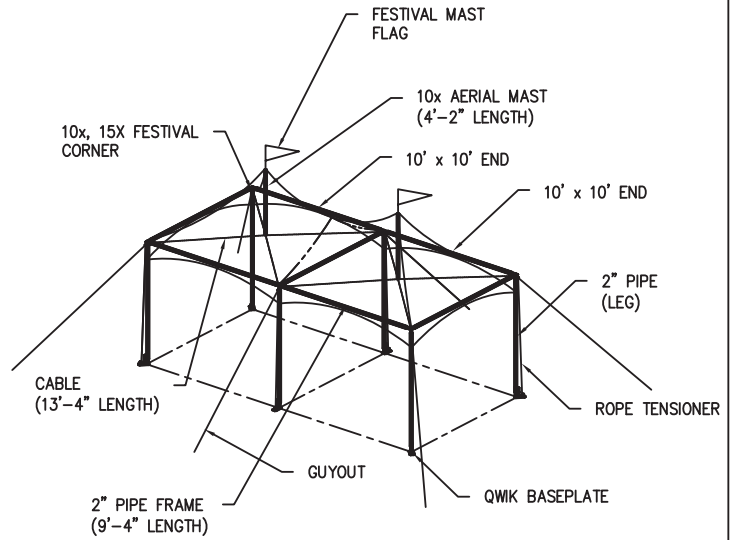

10x20 1PC. FESTIVAL

USE DESIRED MIDDLES TO REACH REQUIRED LENGTH

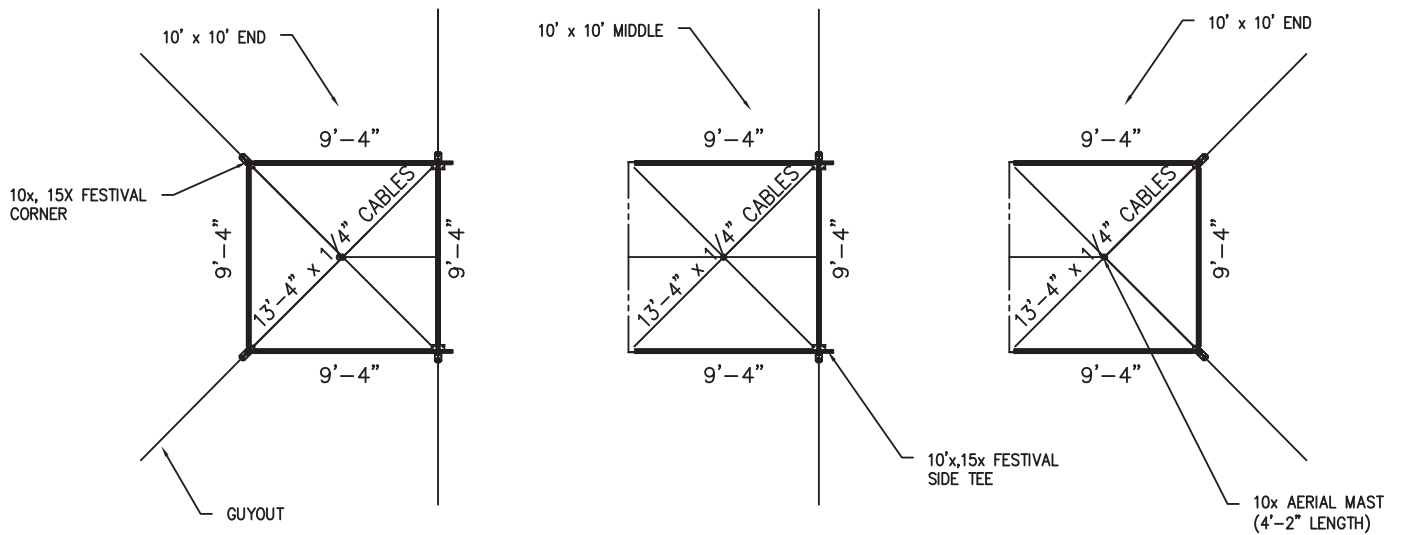

10x30 EXPANDABLE FESTIVAL

REVISION HISTORY			
REV.	DESCRIPTION	BY:	DATE:

SALES

ENGINEER:	N/A	DATE:	6/2/2017
PAGE:	1 OF 1	DRAWN:	ELVIS

FESTIVAL FRAME TENT
10'W FESTIVAL CONFIGURATION
PART NUMBER:

DESIGN & PRODUCTION
 2665 COLUMBIA ST. TORRANCE, CA. 90503
 (800) 228-3687 - FAX (310) 381-0722

ALL DATA AND INFORMATION CONTAINED IN OR DISCLOSED BY THIS DOCUMENT IS CONFIDENTIAL AND PROPRIETARY INFORMATION OF AZTEC TENTS AND ALL RIGHTS THEREIN ARE EXPRESSLY RESERVED. BY ACCEPTING THIS MATERIAL THE RECIPIENT AGREES THAT THIS MATERIAL AND INFORMATION CONTAINED THEREIN IS HELD IN CONFIDENCE AND IN TRUST AND WILL NOT BE COPIED, REPRODUCED WHOLE OR IN PART, NOR ITS CONTENTS REVEALED IN ANY MANNER TO OTHERS, EXCEPT TO MEET THE SPECIFIC PURPOSE FOR WHICH IT WAS DELIVERED.

20' WIDE FESTIVAL CONFIGURATION

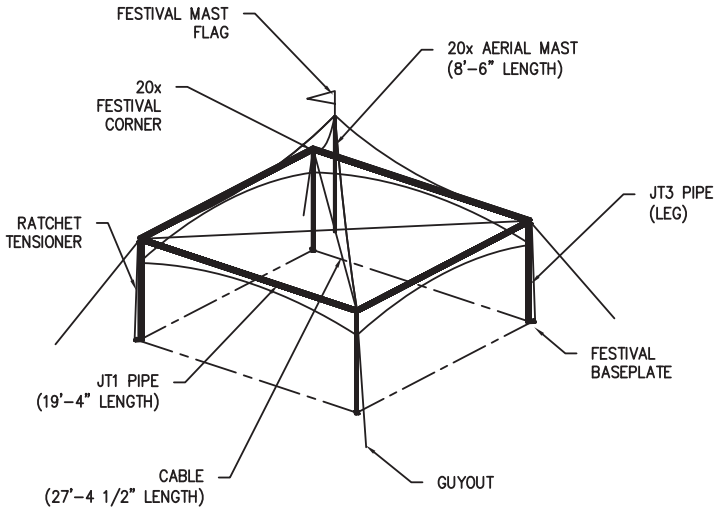

20x20 1PC. FESTIVAL

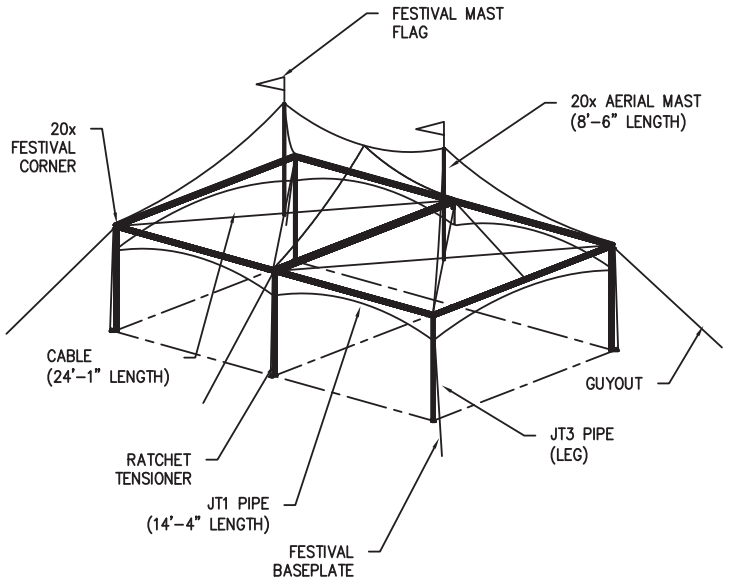

20x30 1PC. FESTIVAL

USE DESIRED MIDDLES TO REACH REQUIRED LENGTH

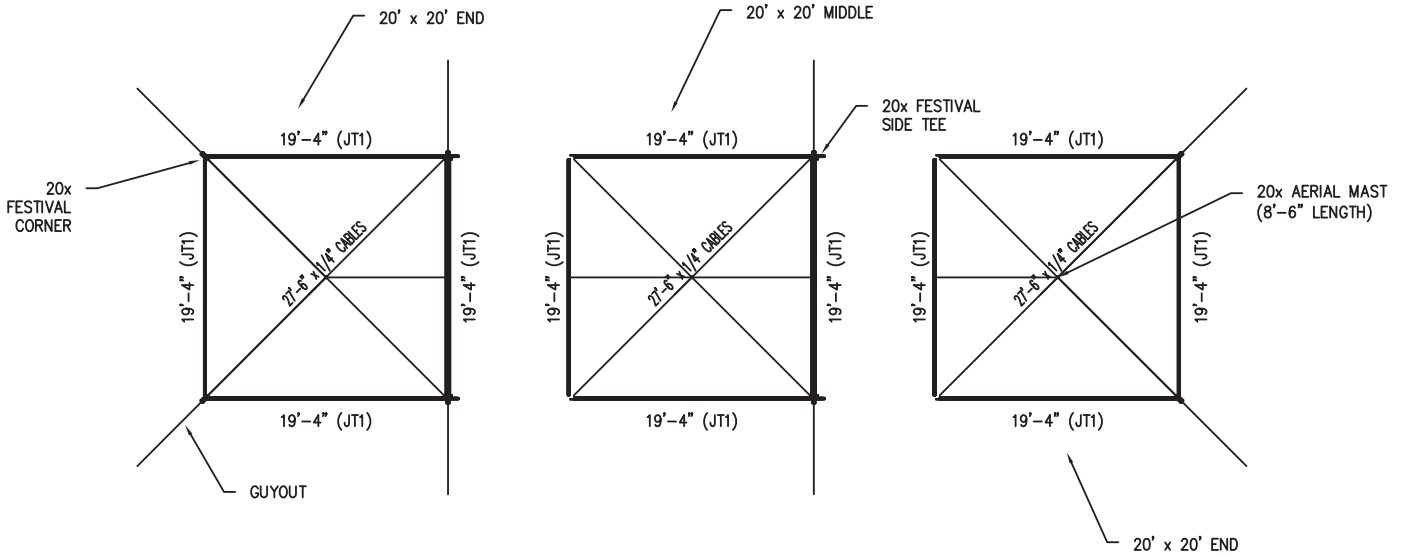

20x60 EXPANDABLE FESTIVAL

REVISION HISTORY			
REV.	DESCRIPTION	BY	DATE

SALES

ENGINEER: N/A DATE: 8/3/2017
 PAGE: 1 OF 1 DRAWN: ELVIS

FESTIVAL FRAME TENT
 20'W FESTIVAL CONFIGURATION
 PART NUMBER:

AZTEC TENTS
 DESIGN & PRODUCTION
 2665 COLUMBIA ST. TORRANCE, CA. 90503
 (800) 228-3687 - FAX (310) 381-0722

ALL DATA AND INFORMATION CONTAINED IN OR DISCLOSED BY THIS DOCUMENT IS CONFIDENTIAL AND PROPRIETARY INFORMATION OF AZTEC TENTS AND ALL RIGHTS THEREIN ARE EXPRESSLY RESERVED. BY ACCEPTING THIS MATERIAL THE RECIPIENT AGREES THAT THIS MATERIAL AND INFORMATION CONTAINED THEREIN IS HELD IN CONFIDENCE AND IN TRUST AND WILL NOT BE COPIED, REPRODUCED WHOLE OR IN PART, NOR ITS CONTENTS REVEALED IN ANY MANNER TO OTHERS, EXCEPT TO MEET THE SPECIFIC PURPOSE FOR WHICH IT WAS DELIVERED.

30' WIDE FESTIVAL CONFIGURATION

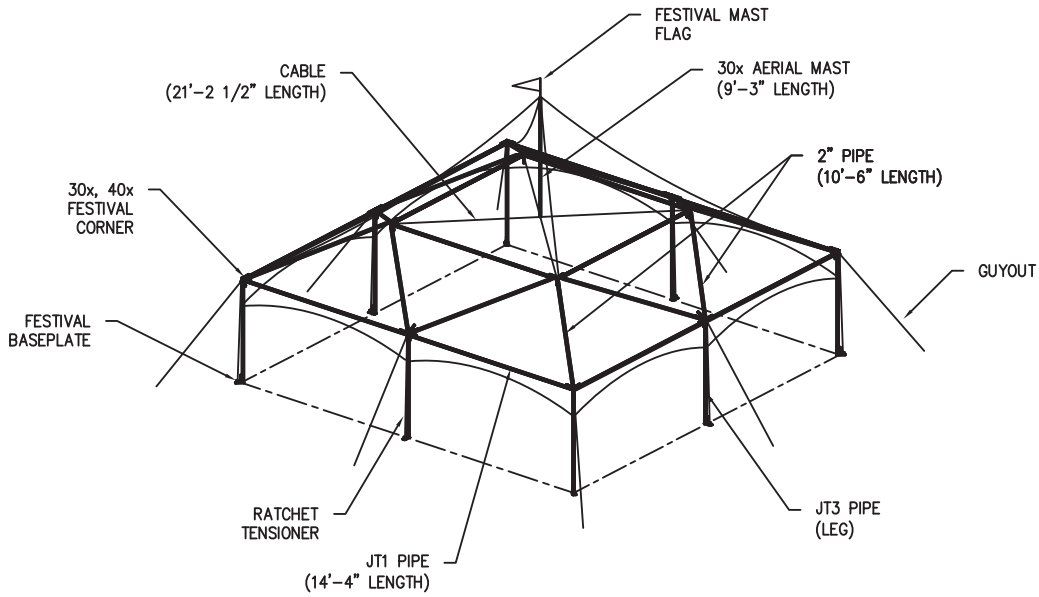

30x30 1PC. FESTIVAL

USE DESIRED MIDDLES TO REACH REQUIRED LENGTH

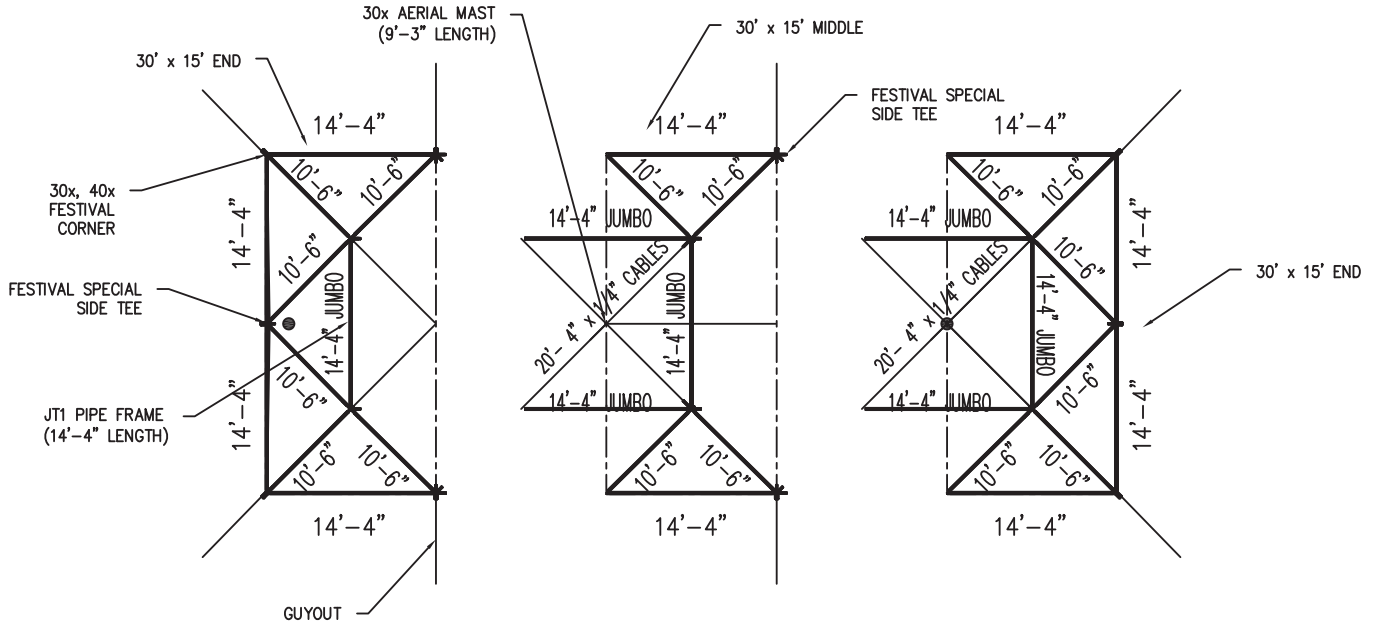

30x45 EXPANDABLE FESTIVAL

REVISION HISTORY			
REV.	DESCRIPTION	BY:	DATE:

SALES	
ENGINEER: N/A	DATE: 8/3/2017
PAGE: 1 OF 1	DRAWN: ELVIS

FESTIVAL FRAME TENT
30'W FESTIVAL CONFIGURATION
PART NUMBER:

DESIGN & PRODUCTION
 2665 COLUMBIA ST. TORRANCE, CA. 90503
 (800) 228-3687 - FAX (310) 381-0722

ALL DATA AND INFORMATION CONTAINED IN OR DISCLOSED BY THIS DOCUMENT IS CONFIDENTIAL AND PROPRIETARY INFORMATION OF AZTEC TENTS AND ALL RIGHTS THEREIN ARE EXPRESSLY RESERVED. BY ACCEPTING THIS MATERIAL THE RECIPIENT AGREES THAT THIS MATERIAL AND INFORMATION CONTAINED THEREIN IS HELD IN CONFIDENCE AND IN TRUST AND WILL NOT BE COPIED, REPRODUCED WHOLE OR IN PART, NOR ITS CONTENTS REVEALED IN ANY MANNER TO OTHERS, EXCEPT TO MEET THE SPECIFIC PURPOSE FOR WHICH IT WAS DELIVERED.

40' WIDE FESTIVAL CONFIGURATION

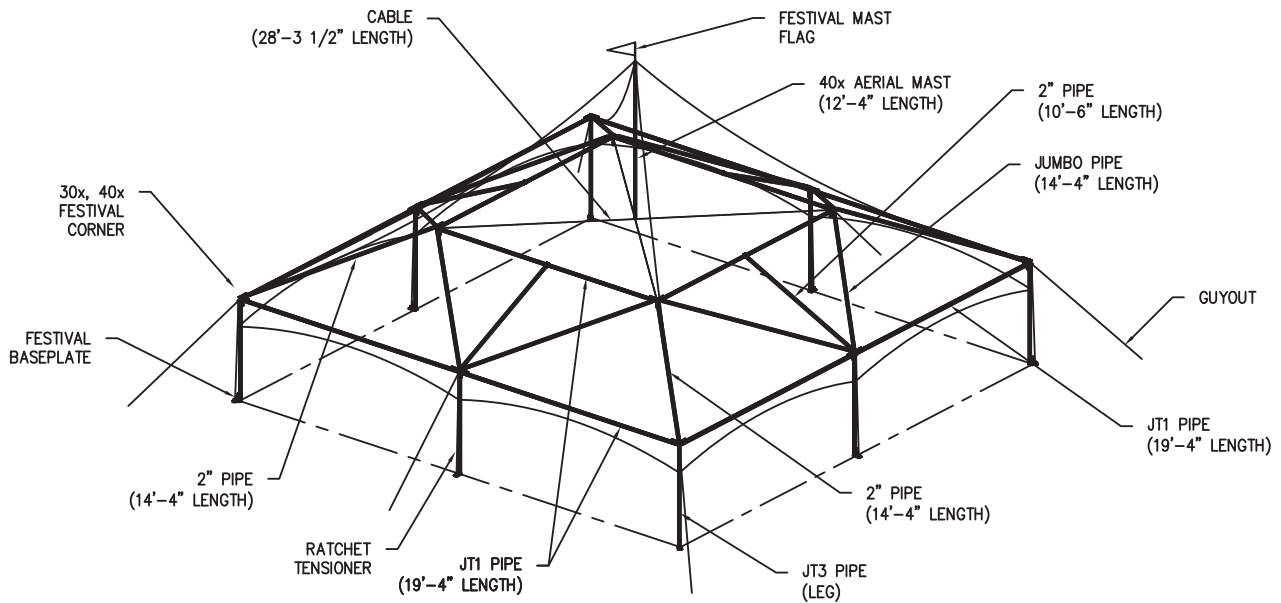

40x40 1PC. FESTIVAL

USE DESIRED MIDDLES TO REACH REQUIRED LENGTH

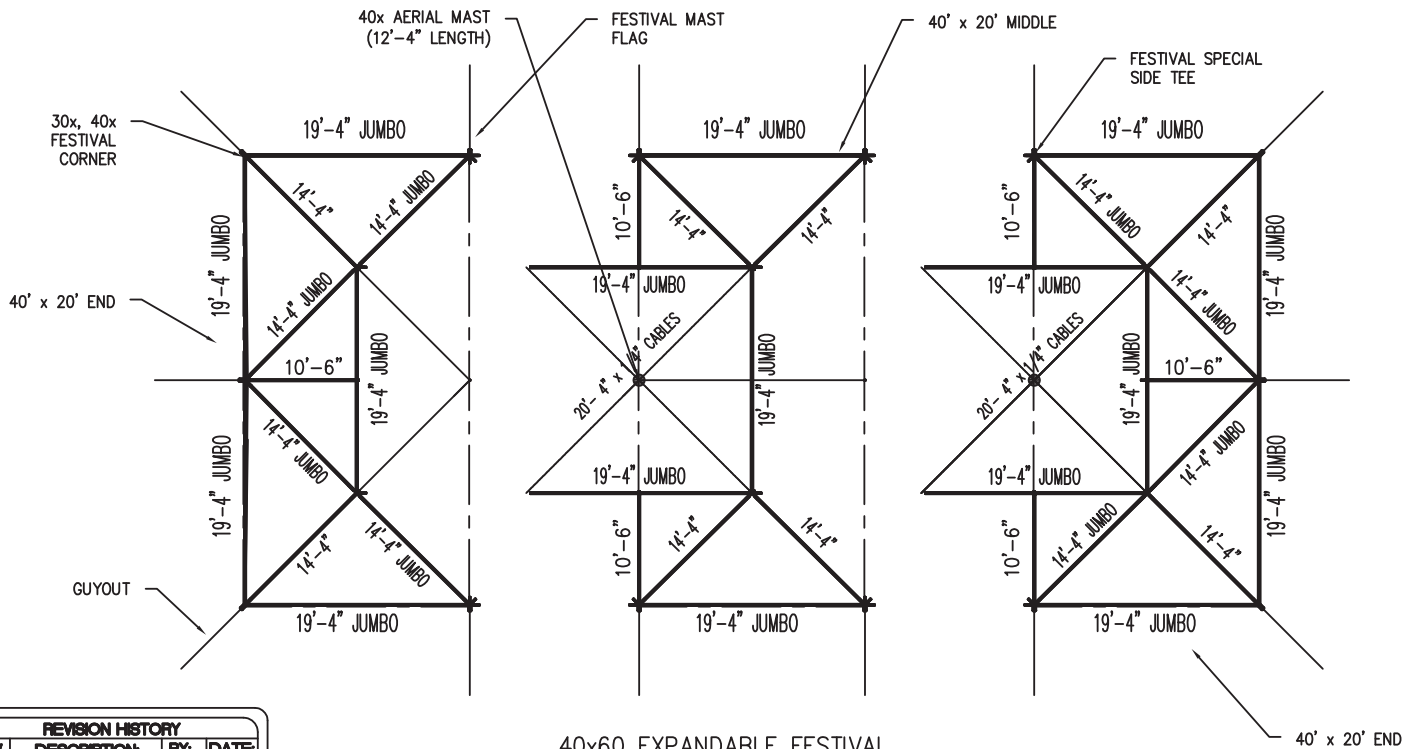

40x60 EXPANDABLE FESTIVAL

REVISION HISTORY			
REV.	DESCRIPTION	BY:	DATE:

SALES	
ENGINEER: N/A	DATE: 8/4/2017
PAGE: 1 OF 1	DRAWN: ELVIS

FESTIVAL FRAME TENT
40'W FESTIVAL CONFIGURATION
PART NUMBER:

DESIGN & PRODUCTION
 2665 COLUMBIA ST. TORRANCE, CA. 90503
 (800) 228-3687 - FAX (310) 381-0722

ALL DATA AND INFORMATION CONTAINED IN OR DISCLOSED BY THIS DOCUMENT IS CONFIDENTIAL AND PROPRIETARY INFORMATION OF AZTEC TENTS AND ALL RIGHTS THEREIN ARE EXPRESSLY RESERVED. BY ACCEPTING THIS MATERIAL THE RECIPIENT AGREES THAT THIS MATERIAL AND INFORMATION CONTAINED THEREIN IS HELD IN CONFIDENCE AND IN TRUST AND WILL NOT BE COPIED, REPRODUCED WHOLE OR IN PART, NOR ITS CONTENTS REVEALED IN ANY MANNER TO OTHERS, EXCEPT TO MEET THE SPECIFIC PURPOSE FOR WHICH IT WAS DELIVERED.

Festival® Parts Images



Festival Corner 10x/15x



Festival Corner 20x



Festival Corner 30x/40x

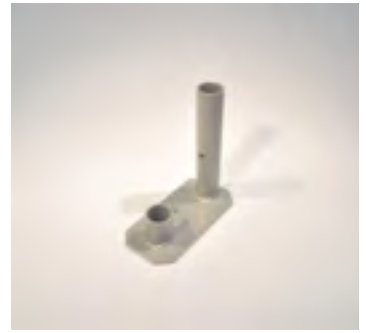

Owik Footplate

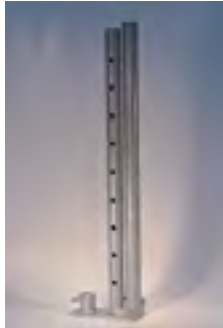

Owik Footplate 2' Adjustable



Festival Hex 120 Degree Corner



Festival Side Fitting 10x/15x



Festival Jumbo Side Fitting 20x



Festival Jumbo Special "T"



Festival Intermediate



Festival Jumbo Cross "T"



Festival Conversion Top "T"



Festival Jumbo Slide Rafter



Mid-Span Tensioner



Festival Conversion 8 Way Crown



Festival Conversion 6 Way Crown



Festival Cable 10x



Festival 30' Cross Cable



Festival Cable Truss Assembly 40x



Festival Mast Flag

Festival® Parts Images



Adjustable Mast Bottom



Festival MastTop Pin

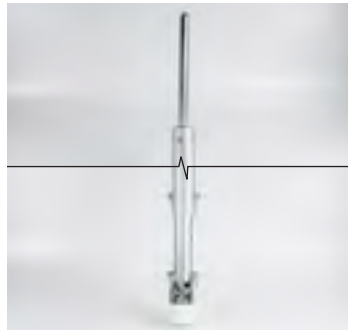

Festival Adjustable Mast



Festival Bottom Mast Cap

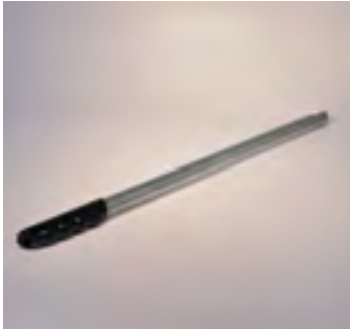

Festival Tool



Jumbo Pin



Festival Jumbo Pipe Clamp



1"x42" Double Headed Stake



1/2" Polypro x 18' Rope



1" Inline Ratchet w/ 10' Web Guy



2" Inline Ratchet w/ 12' Web Guy



Festival Rope Tensioner 10x/15x



Festival Ratchet Tensioner

Festival[®] Engineering Specifications

Design Criteria: 10'x, 15'x, 20'x, 30'x, & 40'x Festival Systems

Code: ASCE/SEI 7-10

Wind Speed: 105MPH 3-Second Gust Exposure "C"

Mean Recurrence Interval (MRI): 7.5 Years

Notes:

External Guys to be installed at 45 degree from horizontal

Tent not to be located near abrupt changes in topography

Soil conditions will vary from site to site. The included anchoring package for this tent may need to be supplemented with additional or alternate anchoring to meet the loads below. The below chart lists the required resistance loads that must be supported by the anchoring system to meet the engineering loads specified under the code.

A Factor of Safety of 2.0 times the design load has been used for the pull out tension in lbs that the anchoring devices must resist in the direction of the load. Ensure that the anchors installed are adequate to resist pull out loads show on the diagram. Actual testing of some individual anchors to 75% of the anchor pull-out load is recommended.

Festival® Load Summary- 10' Width

SAMPLE

1,000	ACTUAL LOAD VALUE
2,000	MINIMUM DESIGN LOAD FOR ANCHORING SYSTEM*

* MINIMUM DESIGN LOAD FOR ANCHORING SYSTEM IS CALCULATED USING A FACTOR OF SAFETY = 2.0. SOME FIXED MECHANICAL ANCHORS HAVING ULTIMATE LOADS IN EXCESS OF THIS SPECIFIED LOAD CAN BE USED, BUT THOSE ANCHORS MUST ALSO HAVE ALLOWABLE/WORKING LOADS GREATER THAN ACTUAL LOAD VALUE.

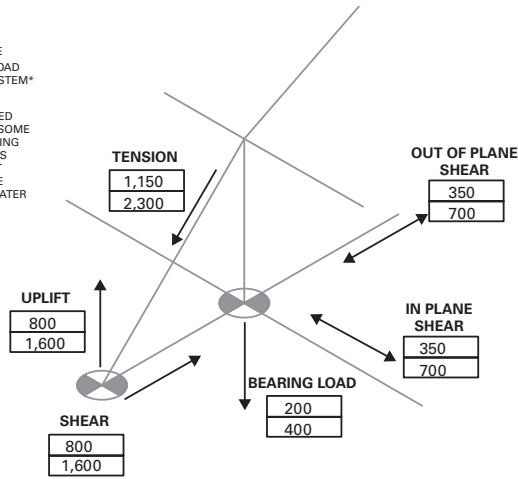

Festival® Load Summary- 15' Width

SAMPLE

1,000	ACTUAL LOAD VALUE
2,000	MINIMUM DESIGN LOAD FOR ANCHORING SYSTEM*

* MINIMUM DESIGN LOAD FOR ANCHORING SYSTEM IS CALCULATED USING A FACTOR OF SAFETY = 2.0. SOME FIXED MECHANICAL ANCHORS HAVING ULTIMATE LOADS IN EXCESS OF THIS SPECIFIED LOAD CAN BE USED, BUT THOSE ANCHORS MUST ALSO HAVE ALLOWABLE/WORKING LOADS GREATER THAN ACTUAL LOAD VALUE.

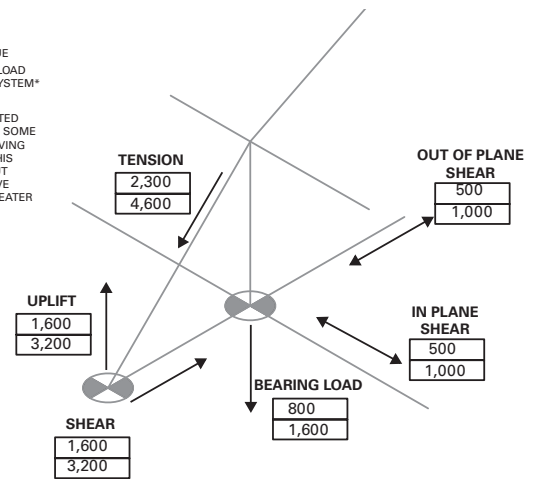

Festival® Load Summary- 20' Width

SAMPLE

1,000	ACTUAL LOAD VALUE
2,000	MINIMUM DESIGN LOAD FOR ANCHORING SYSTEM*

* MINIMUM DESIGN LOAD FOR ANCHORING SYSTEM IS CALCULATED USING A FACTOR OF SAFETY = 2.0. SOME FIXED MECHANICAL ANCHORS HAVING ULTIMATE LOADS IN EXCESS OF THIS SPECIFIED LOAD CAN BE USED, BUT THOSE ANCHORS MUST ALSO HAVE ALLOWABLE/WORKING LOADS GREATER THAN ACTUAL LOAD VALUE.

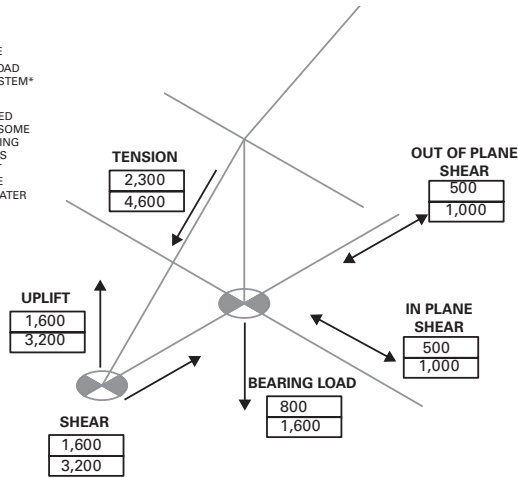

Festival® Load Summary- 30' Width

SAMPLE

1,000	ACTUAL LOAD VALUE
2,000	MINIMUM DESIGN LOAD FOR ANCHORING SYSTEM*

* MINIMUM DESIGN LOAD FOR ANCHORING SYSTEM IS CALCULATED USING A FACTOR OF SAFETY = 2.0. SOME FIXED MECHANICAL ANCHORS HAVING ULTIMATE LOADS IN EXCESS OF THIS SPECIFIED LOAD CAN BE USED, BUT THOSE ANCHORS MUST ALSO HAVE ALLOWABLE/WORKING LOADS GREATER THAN ACTUAL LOAD VALUE.

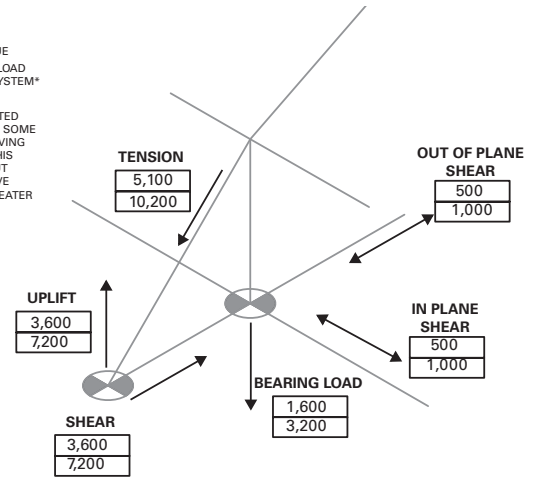

Festival® Load Summary- 40' Width

SAMPLE

1,000	ACTUAL LOAD VALUE
2,000	MINIMUM DESIGN LOAD FOR ANCHORING SYSTEM*

* MINIMUM DESIGN LOAD FOR ANCHORING SYSTEM IS CALCULATED USING A FACTOR OF SAFETY = 2.0. SOME FIXED MECHANICAL ANCHORS HAVING ULTIMATE LOADS IN EXCESS OF THIS SPECIFIED LOAD CAN BE USED, BUT THOSE ANCHORS MUST ALSO HAVE ALLOWABLE/WORKING LOADS GREATER THAN ACTUAL LOAD VALUE.

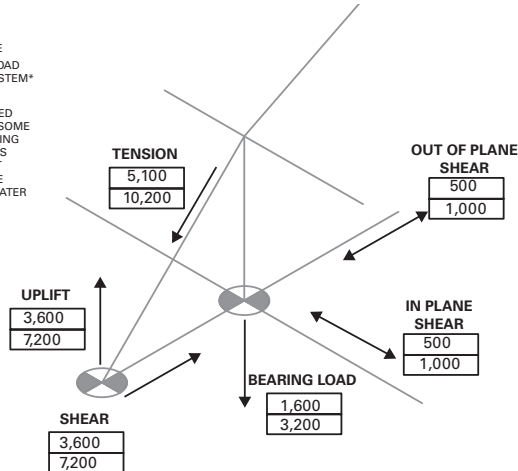

Festival® Components

Fittings/Components	Item Number	Weight lbs
Festival Corner 10/15	Z29700010	5
Festival Corner 20X	Z29700020	10
Festival Corner 30X 40X	Z29700030	13
Fest HEX 120 Degree Corner	Z29700035	14
Festival Side Fitting 10X 15X	Z29700040	6
Fest Jumbo Side Fitting 20X	Z29700050	12
Festival Jumbo Sp Tee 30X 40X	Z29700060	14
Festival Intermediate	Z29700070	15
Festival Jumbo Cross Tee	Z29700080	13
Festival Cable 10X	Z29700090	3
Festival Cable 10X15	Z29700095	3
Festival Cable 15X 30X	Z29700100	4
Festival Cable 20x15	Z29700110	4
Festival Cable 20X 40X	Z29700120	5
Fest. 30x HEX Cable(29'-1.5")	Z29700129	6
Festival 30' Cross Cable	Z29700130	6
Festival 40' Cross Cable	Z29700140	7
Festival Aerial Mast 10X	Z29700150	27
Festival Aerial Mast 15X	Z29700160	33
Festival Aerial Mast 20X	Z29700170	41
Festival Aerial Mast 30X	Z29700180	47
Festival Aerial Mast 40X	Z29700190	56
Festival Fabric Tool	Z29700250	2
Festival Rope Tensioner 10x15x	Z29700260	0
Fest Ratchet Tensioner 20/30/40	Z29700270	1
Fest Jumbo Slide Rafter Ftg.	Z29700280	5
Fest Jumbo Pipe Clamp	Z29700290	4
Mid-Span Tensioner	Z299F00210	2
Qwik Footplate	Z299F00200	4
2' Adjustable Qwik Baseplate	Z299F00180	8
Fest Footplate 20/30/40	Z29700300	5
Festival 2' Adj. Footplate	Z29700310	13
10' Festival Gutter	Z29700320	5
15' Festival Gutter	Z29700330	6
20' Festival Gutter	Z29700340	9
Fest Cable Truss Assembly 40x	Z29700350	12
Festival Mast Flag Black	Z29700360BK	1
Festival Mast Flag Blue	Z29700360BL	1
Festival Mast Flag Green	Z29700360GR	1
Festival Mast Flag Red	Z29700360RD	1
Festival Mast Flag White	Z29700360UW	1
Festival Mast Flag Yellow	29700360YL	1
Festival Bottom Mast Cap	Z29700370	1
Festival Mast Bottom w/Wheel	Z29700380	7
Festival Mast Top Pin	Z29700390	6
Acadapin/Assembly Pin	Z299F00160	0.1
Jumbo Pin	Z299F00170	0.1
7' 8" - 2" Pipe	Z299P20708	7
9' 4" - 2" Pipe	Z299P20904	8
10' 6" - 2" Pipe	Z299P21006	10
14' 4" - 2" Pipe	Z299P21404	13
7' 8" - Jumbo Pipe	Z299PJ0708	14
9' 4" - Jumbo Pipe	Z299PJ0904	18
14' 4" - Jumbo Pipe	Z299PJ1404	27
Jumbotrac JT1 19'4"	Z298JT11904	40
1" x 42" Double Headed Stake	Z51100070	10
1" Inline Ratchet w/ 10' Web Guy	Z39900280	3
2" Inline Ratchet w/ 12' Web Guy	Z39900290	6
1/2" Polypro x 18' Rope	Z299F00220	1

If YOU can IMAGINE it... WE can BUILD it

www.aztectents.com

Aztec Tents

2665 Columbia Street
Torrance, CA 90503
Toll Free (800) 228-3687
Fax (310) 381-0722