

INSTALL INSTRUCTIONS



If YOU can IMAGINE it... WE can BUILD it

LEGEND SERIES

WARNING!

The safe installation and use of commercial tenting products can vary from site to site and during varying climactic conditions. Careful consideration should be paid to any installation during windy conditions and shall be monitored throughout the duration of the installation. Periodic maintenance and monitoring of the installation by the installer is required. Techniques other than those specified in this document may be required during these types of conditions.

Users and installers shall indemnify and hold harmless Aztec Tent for any claim resulting from the improper installation and/or maintenance of this unit.

Soil conditions also vary from site to site. The included anchoring package for this tent may need to be supplemented with alternate anchoring during windy conditions and in areas with questionable soil holding power. Full product engineering may be available.

NOTICE

This tent product is not intended to be used as a shelter from severe weather. Aztec assumes no liability for such use. An evacuation plan for the area covered within this tented space is imperative and shall be thoroughly posted for all users and potential occupants of the tent. Severe weather including electrical storm systems, moderate to severe wind, heavy rains, snow, or any condition that raises any doubt to the structural integrity of the tent are immediate signs that an evacuation is necessary. Severe bodily injury and/or death can occur.

The installation of electrical, plumbing, lighting, appliances and/or HVAC equipment are not covered within this manual. Users/Installers shall follow local code requirements for the installation of these items using certified personnel. Aztec Tents shall be indemnified and held harmless from any such use or injury resulting from its use.

IMPORTANT SAFETY INFORMATION

Proper personnel safety equipment should be worn at all times during the installation of any tenting products.

Hard Hat

Safety Glasses

Work Gloves

Long Pants

Steel Toe Boots

OSHA Approved Harness and restraint system (for off ground activities)

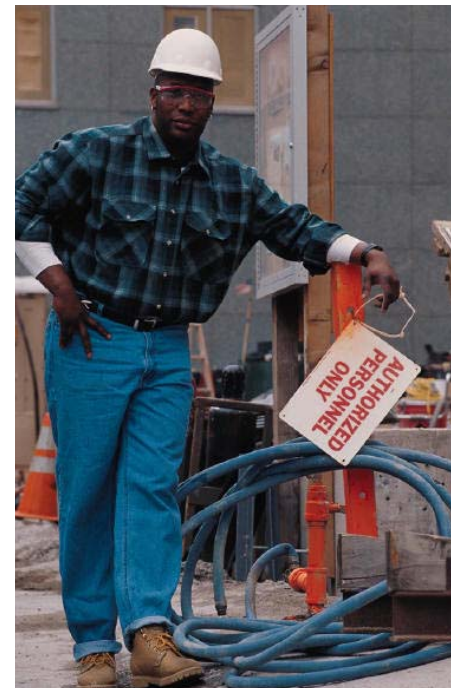

Thank you for your recent purchase from Aztec Tents. The following procedures will help you through your installation. If you ever run into problems with the installation of your Aztec Tent give one of our sales/service professionals a call. A complete listing of sales, service, and operational support is always available on our website at www.aztectents.com.

Contents

Installation Instructions	4-9
40-50-60 Design Drawings	10-11
60-80-100-120 Design Drawings	12-19
Anchoring Detail	20
Fabric Layout Diagrams	21-27
Replacement Parts	28

Questions? Call us.

Aztec Tents

2665 Columbia Street
Torrance, CA 90503 USA
Direct (310) 347-3010
Toll Free (800) 228-3687
Fax (310) 381-0722

Installation-

Step 1:

Square the tent area. Use the below squaring diagram to determine the diagonal or "C" Dimension your tent installation. To calculate your own squaring dimension for your width/length combination use the formula $A^2+B^2=C^2$.

LENGTH- "B"	WIDTH- "A"						
	20'	30'	40'	50'	60'	80'	100'
20	28'3"	36'1"	44'9"	53'10"	63'3"	82'6"	102'
30	36'1"	42'5"	50'	58'4"	67'1"	85'5"	104'5"
40	44'9"	50'	56'7"	64'	72'1"	89'5"	107'8"
50	53'10"	58'4"	64'	70'9"	78'1"	94'4"	111'10"
60	63'3"	67'1"	72'1"	78'1"	84'10"	100'	116'7"
70	72'10"	76'2"	80'7"	86'	92'2"	106'4"	122'1"
80	82'6"	85'5"	89'5"	94'4"	100'	113'2"	128'1"
90	92'2"	94'10"	98'6"	102'11"	108'2"	120'5"	134'6"
100	102'	104'5"	107'8"	111'10"	116'7"	128'1"	141'5"
120	121'8"	123'8"	126'6"	130'	134'2"	144'3"	156'2"
130	131'6"	133'5"	136'	139'3"	143'2"	152'8"	164'
140	141'5"	143'2"	145'7"	148'8"	152'4"	161'3"	172'
150	151'4"	153'	155'3"	158'1"	161'7"	170'	180'3"
160	161'3"	162'9"	164'11"	167'7"	170'11"	178'11"	188'8"
170	171'2"	172'8"	174'8"	177'2"	180'3"	187'11"	197'3"
180	181'1"	182'6"	184'5"	186'10"	189'9"	197'	205'11"
190	191'1"	192'4"	194'2"	196'6"	199'3"	206'2"	214'9"
200	201'	202'3"	204'	206'2"	208'10"	215'5"	223'7"

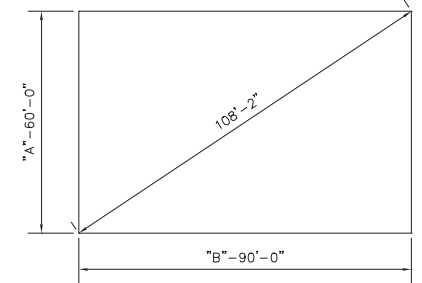
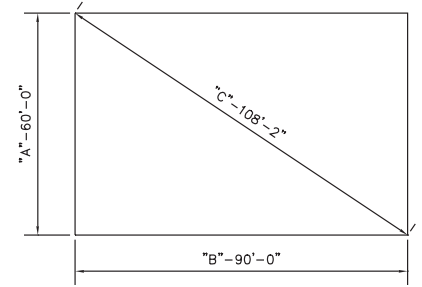

Step 2:

Mark on the ground with chalk or spray paint the location of the leg and center poles. These locations are identified on the drawing to the right. All legs are spaced 10' on center around the perimeter of the tent. Refer to the diagrams included with this manual for the pole locations for the various sizes.

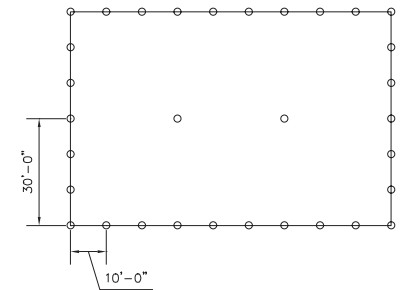

Step 3:

Mark on the ground the location of each staking bar. The dimensions shown indicate the center of each bar. Each bar is placed equal distance away from each leg as the height of the leg. Note: refer to the included diagrams for proper anchoring recommendations.

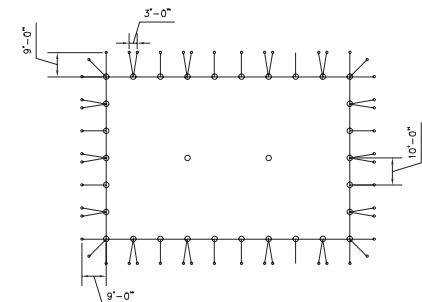

Step 4:

Drive the anchoring stakes. Place the staking ratchet under the center hole of the staking bar and insert the 1" x 42" double headed stake through both holes. Drive the stake with a sledge hammer, air hammer, or gas powered hammer completely into the ground until it makes contact with the staking bar. Continue driving the outer two stakes through the staking bar into the ground. Continue with all stakes.



The final anchored product will look like the picture shown to the right.



Step 5:

Layout a ground cloth over the ground in the tent area. This will protect the tent top fabric. Position all of the centerpoles on top of the ground cloth so that the pin of the centerpole lays directly above the mark you made on the ground for the centerpole location. The centerpoles should all lay in the same direction so that the bottom points toward the end of the tent. Begin laying out the tent fabric per the layout diagram on pages 21-23. The tent pieces are labeled with a metal tag according to their location on the tent

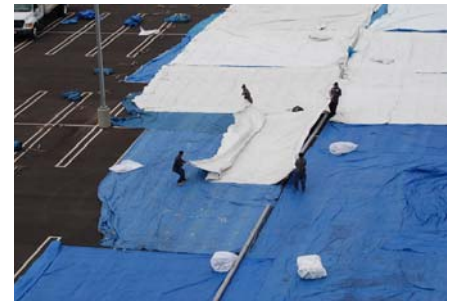

Step 6:

Install the 4" round ring located at the top of each tent fabric piece over the top of the centerpole. You should use a small piece of rope to tie the four rings to the centerpole top pin to prevent them from sliding off during installation and lifting of the centerpoles in step 17.



Step 7:

Begin lacing the tent sections together. See to illustration to the right for proper lacing technique. On valley lace lines you start lacing from the middle of the laceline toward the pole pins. On all eave to peak lacelines, you start lacing at the centerpole pin and work down to the eave or perimeter of the tent top.

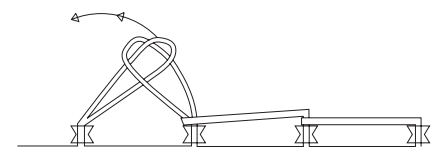

Step 8:

Proper lacing technique shown to the right, using both hands to push the lace of the under panel through the grommet of the upper panel and pulling down to the next set of grommet and lace.



Step 9:

When you come to the end of the lace line the lace is terminated with a double knot as shown to the right.



Step 10:

Now seal the rain flap over the lace connection. Be sure to lay the velcro flap flat and smoothly join the velcro connection so that there are not bumps and that the velcro has full strength to join to the other section.



Step 11:

On all twin and tripple pole models a web strap and hook from the top middle (section 2-2) is connected to a ring on the side middles (sections 2-1 and 2-3). This connection is not used on the single pole models and therefore the rings on the side middles are not used.



Step 12:

Begin installing the legs of the tent. First insert the pin of the corner leg pole through the ring on the corner of the tent. Attach three (3) web guys to the leader rings on the corner connection and apply enough tension with the ratchet to make the leg almost vertical.



Step 13:

Continue down the length of the tent installing legs and lightly tensioning the web guys. Continue with the other long side of the tent, starting at the corner and working down the tent.



Step 14:

Proper tensioning technique shown with socket wrench (not included) to apply enough tension to the leg pole to keep it from falling over.



Step 15:

Photo showing all of the leg poles installed and moderately tensioned.



Step 16:

Starting with the first centerpole on the end of the tent slide a 1" x 42" stake through the hole approximately 36" up from the bottom of the centerpole and set stake on the forks of a forklift as shown. Laborers will need to access the top of the centerpole by pushing up the fabric and walking toward the top of the centerpole. Using manpower the top of the centerpole is lifted vertically as the forklift gently moves forward. Once the pole is supported by the lift and the tension of the fabric is holding it off the ground the laborers should move away from the centerpole as the lift continues to slowly move forward.



CAUTION: The top of the centerpole is surrounded by an excess of fabric when low to the ground. Be very careful that the fabric on the outside of the tent does not catch on the centerpole pin. A spotter is highly recommended to solely watch the pin and fabric from the outside and make any adjustments necessary to free the caught fabric.



Step 17:

Use the lift to position the bottom of the centerpole directly on the mark on the ground that you previously made. As you raise the first centerpole the next centerpole will lift slightly off the ground from tension of the tent fabric. Be sure as the adjoining centerpoles begin to raise they do not fall out of the rings.



Photo to the right shows “spotter” watching and assisting the positioning of the centerpoles from the outside. Be certain to wear proper harness and restraint system.



Step 18:

As the centerpoles are raised you might need to loosen some of the perimeter web guys to avoid overly straining the top fabric during the installation of the centerpoles. To release tension on the ratchet depress the gold colored toggle on the top of the ratchet mechanism with your boot or by gently tapping it with a stake.



Step 19:

Once all the centerpoles are installed you can begin to straighten all of the legs and tensioning all of the ratchet straps. Start with the four (4) corner legs first, make sure they are positioned on the ground mark and then re-tension the web guys so that the leg is plumb. Continue working down both sides of the tent to straighten the legs and tensioning to plumb.

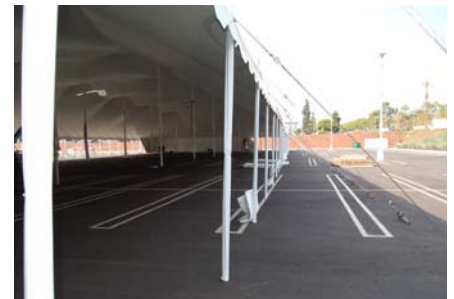

Step 20:

Photo of the fully tensioned Legend Tension Tent.



WARNING: The safe installation and use of commercial tenting products can vary from site to site and during varying climactic conditions. Careful consideration should be paid to any installation during windy conditions. Techniques other than those specified above may be required during these types of conditions.

Soil conditions also vary from site to site. The included anchoring package for this tent may need to be supplemented with alternate anchoring during windy conditions and in areas with questionable soil holding power. Full product engineering is available, but not included, by the manufacturer including structural engineering and site specific soil engineering.

Questions pertaining to the proper procedure for the installation of this and any tent product manufactured by AztecTents should be directed to our design staff at (800) 228-3687.

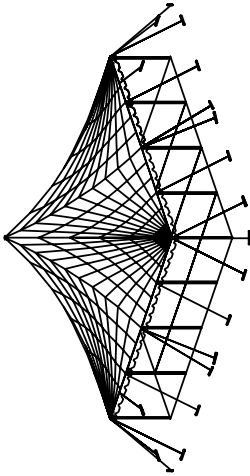

ISOMETRIC ELEVATION

LEGEND 40-50-60
40' x 40'

- (2) 40'x20' ENDS, 4PC.
- (1) 4" ALUM. 2PC. CENTER POLE (8'L 26' / 10'L 28')
- (16) 2-1/2" SCH. 40 ALUM. SIDE POLE (8'L / 10'L)
- (28) STAKE BAR w/ 2" WEB WINCH ASSEMBLY
- (84) 1" x 42" DOUBLE HEADED STAKES

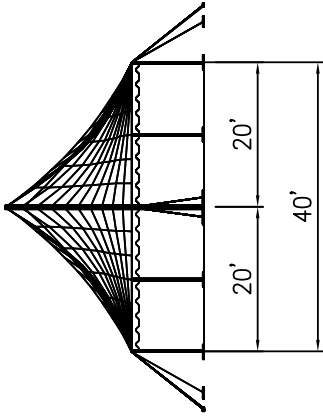

SIDE ELEVATION

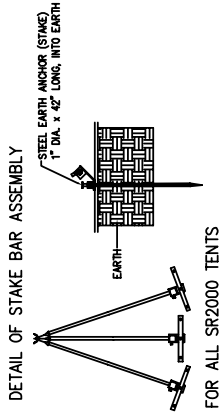

FOR ALL SR2000 TENTS

● = CENTER POLES NOT TO SCALE

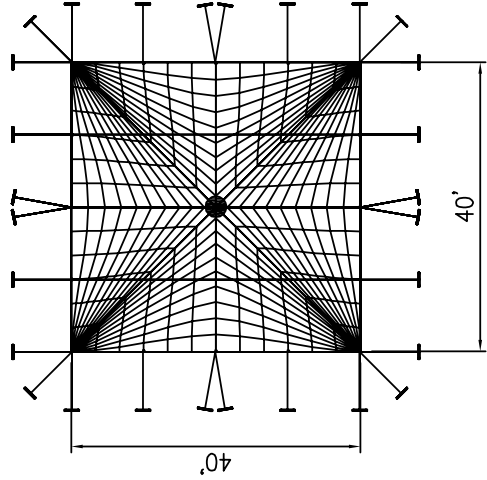

PLAN ELEVATION

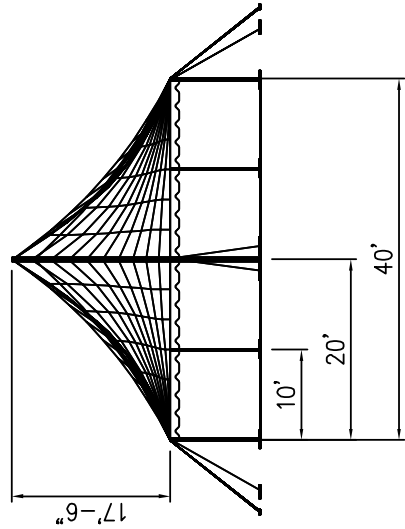

FRONT ELEVATION

ALL DATA AND INFORMATION CONTAINED IN OR DISCLOSED BY THIS DOCUMENT IS CONFIDENTIAL AND PROPRIETARY INFORMATION OF AZTEC TENTS AND ALL RIGHTS THEREIN ARE EXPRESSLY RESERVED. BY ACCEPTING THIS MATERIAL THE RECIPIENT AGREES THAT THIS MATERIAL AND INFORMATION CONTAINED HEREIN IS HELD IN CONFIDENCE AND IN TRUST, AND WILL NOT BE COPIED, REPRODUCED WHOLE OR IN PART, NOR ITS CONTENTS REVEALED IN ANY MANNER TO OTHERS, EXCEPT TO MEET THE SPECIFIC PURPOSE FOR WHICH IT WAS DELIVERED.		ENGINEER CM	CHECKED 10/30/08 1440
40-50-60 LEGEND POLE / STANDARD 40'W x 40'L x 20' MIDDLES		DRAWING LEGEND POLE	DATE 10/30/08
PART DESCRIPTION 40-50-60 LEGEND POLE / STANDARD	CODE AZ-40x40x20-LEGEND POLE	SIZE 40-50-60	REV 0

2665 COLUMBIA ST. TORRANCE, CA. 90503
 (800) 228-3687 - FAX (310) 381-0722

LEGEND POLE TENT

40-50-60 LEGEND POLE / STANDARD 40'W x 60'L x 20' MIDDLES	40-50-60	AZ-40x60x20- LEGEND POLE	0
ENGINEER	CM	DATE	10/30/08
DRAWN	FERRANCE R.	CHECKED	-
2665 COLUMBIA ST. TORRANCE, CA 90503 (800) 228-3687 - FAX (310) 581-0722		AZTEC	
ALL DATA AND INFORMATION CONTAINED IN OR DISCLOSED BY THIS DOCUMENT IS CONFIDENTIAL AND PROPRIETARY INFORMATION OF AZTEC TENTS AND ALL RIGHTS THEREIN ARE EXPRESSLY RESERVED. BY ACCEPTING THIS MATERIAL THE RECIPIENT AGREES THAT THIS MATERIAL AND INFORMATION CONTAINED HEREIN IS HELD IN CONFIDENCE AND IN TRUST AND WILL NOT BE COPIED, REPRODUCED WHOLE OR IN PART, FOR ITS CONTENTS REVEALED IN ANY MANNER TO OTHERS, EXCEPT TO MEET THE SPECIFIC PURPOSE FOR WHICH IT WAS DELIVERED.		1440	103008

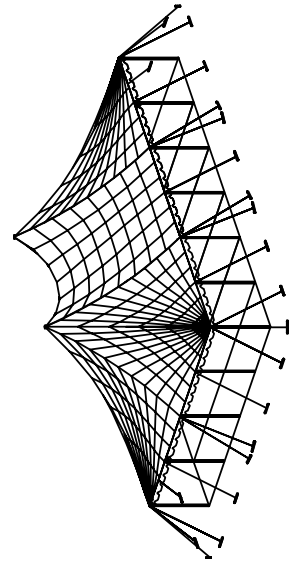

ISOMETRIC ELEVATION

LEGEND 40-50-60
40' x 60'

- (2) 40'x20' ENDS, 4PC.
- (1) 40'x20' MIDDLE, 2PC.
- (2) 4" ALUM. 2PC. CENTER POLE (8'L 26' / 10'L 28')
- (20) 2-1/2" SCH. 40 ALUM. SIDE POLE (8'L / 10'L)
- (34) STAKE BAR w/ 2" WEB WINCH ASSEMBLY
- (102) 1" x 42" DOUBLE HEADED STAKES

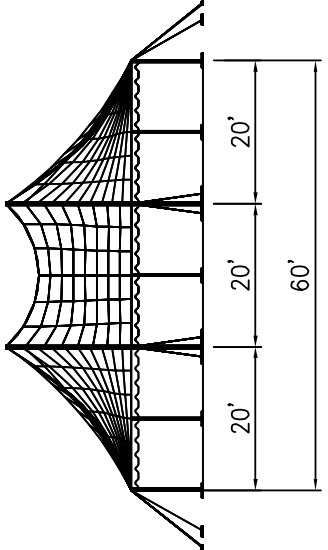

SIDE ELEVATION

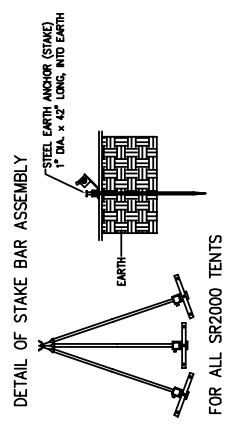

● = CENTER POLES NOT TO SCALE

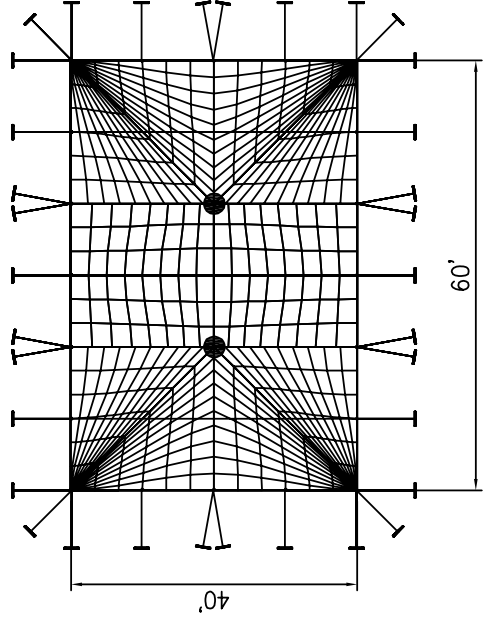

PLAN ELEVATION

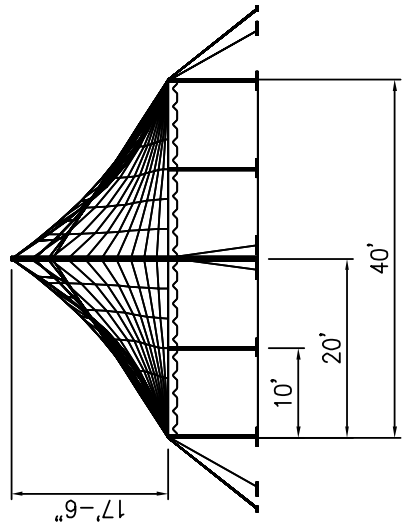

FRONT ELEVATION

50' x 70' Expandable Pole Tent

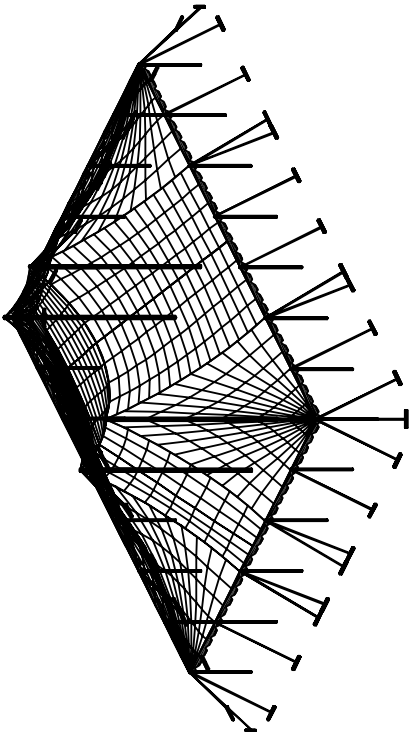

ISOMETRIC ELEVATION

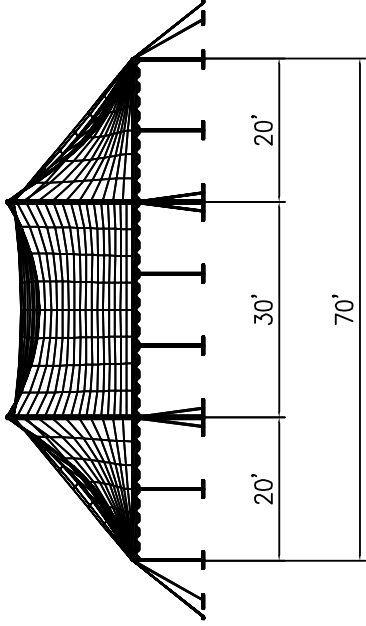

SIDE ELEVATION

50x110 LEGEND POLE

PIPE: 2 1/2"

(32) 6'-8"/9'-4" SIDE POLE (LEG)

(8) CENTER POLES

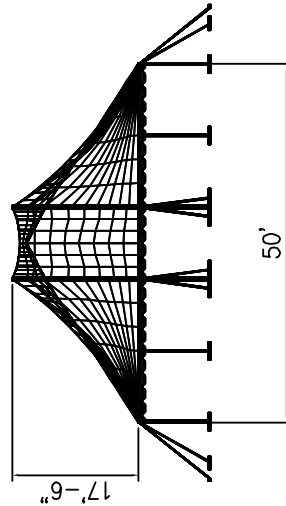

FRONT ELEVATION

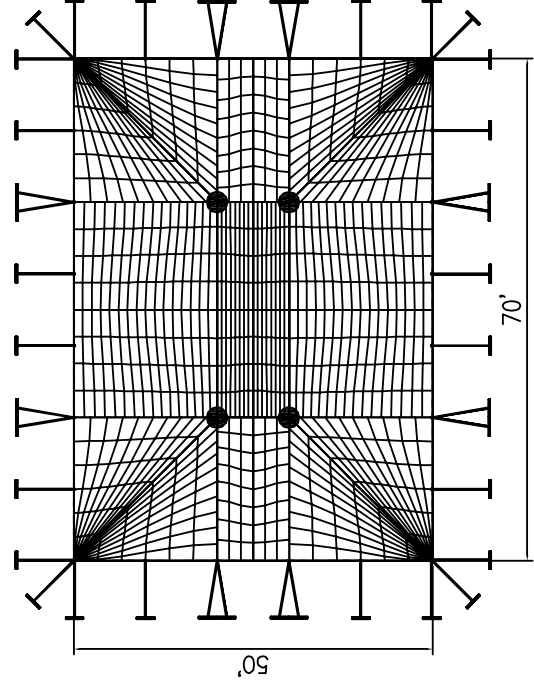

PLAN ELEVATION

● = CENTER POLES NOT TO SCALE

AZT\40120\XXXX		000000	TIME	05-16-2006	DATE	CM	DR	05-16-2006
ALL DATA AND INFORMATION CONTAINED IN OR DISCLOSED BY THIS DOCUMENT IS CONFIDENTIAL AND PROPRIETARY INFORMATION OF AZTEC TENTS AND ALL RIGHTS HEREIN ARE RESERVED. THE RECIPIENT AGREES THAT THIS MATERIAL AND INFORMATION CONTAINED THEREIN IS HELD IN CONFIDENCE AND IN TRUST, AND WILL NOT BE COPIED, REPRODUCED WHOLE OR IN PART, EXCEPT TO MEET THE SPECIFIC PURPOSE FOR WHICH IT WAS DELIVERED.		ENGINEER		CHECKED		DRAWN		05-16-2006
2665 COLUMBIA ST. TORRANCE, CA. 90503 (800) 228-3687 - FAX (310) 381-0722		CM		TTR		LEGEND		0
AZTEC		LEGEND 40-50-60 / STANDARD		PART DESCRIPTION		SIZE		REV
STANDARD		50' W X 70' L X 10' LEGS		DRAWING NUMBER		AZ-50 X 70 X 10-LEGEND		0

AZT\40120\XXXX		000000 TIME	CHECKED	-	DATE	02-24-2006
DELIVERED:		EXCEPT TO MEET THE SPECIFIC PURPOSE FOR WHICH IT WAS				
AND WILL NOT BE COPIED, REPRODUCED WHOLE OR IN PART,		THE RECIPIENT AGREES THAT THIS MATERIAL AND INFORMATION				
CONTAINED HEREIN IS HELD IN CONFIDENCE AND IN TRUST,		ARE EXPRESSLY RESERVED. BY ACCEPTING THIS MATERIAL				
INFORMATION OF AZTEC TENTS AND ALL RIGHTS THEREIN		BY THIS DOCUMENT IS CONFIDENTIAL AND PROPRIETARY				
ALL DATA AND INFORMATION CONTAINED IN OR DISCLOSED						
ENGINEER	CM	DRAWN	TTR	2665 COLUMBIA ST. TORRANCE, CA. 90503 (800) 228-3687 - FAX (310) 381-0722		
PART DESCRIPTION		CODE	SIZE	DRAWING NUMBER		
40-50-60 LEGEND / STANDARD			60'W X 110'L X 20-30 MIDDLES	REV		
LPT		AZ-60 X 110-LEGEND 0				

STANDARD

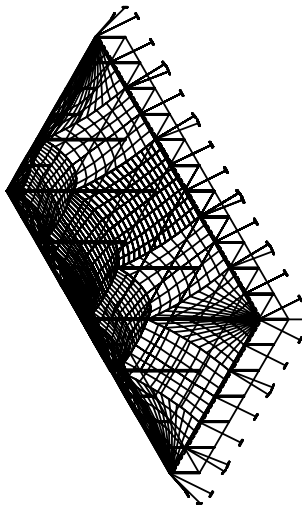

ISOMETRIC VIEW

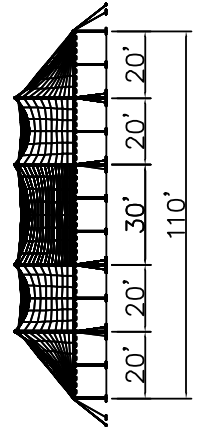

SIDE VIEW

**LEGEND 40-50-60
60' x 110'**

- (1) 60'x40' ENDS, 6PC.
- (1) 60'x30' MIDDLE, 2PC.
- (2) 60'x20' MIDDLE, 2PC.
- (8) 4" ALUM. 2PC. CENTER POLE (8'L 26' / 10'L 28')
- (34) 2-1/2" SCH. 40 ALUM. SIDE POLE (8'L / 10'L)
- (54) STAKE BAR w/ 2" WEB WINCH ASSEMBLY
- (162) 1" x 42" DOUBLE HEADED STAKES

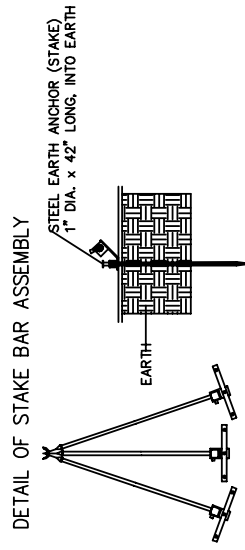

DETAIL OF STAKE BAR ASSEMBLY

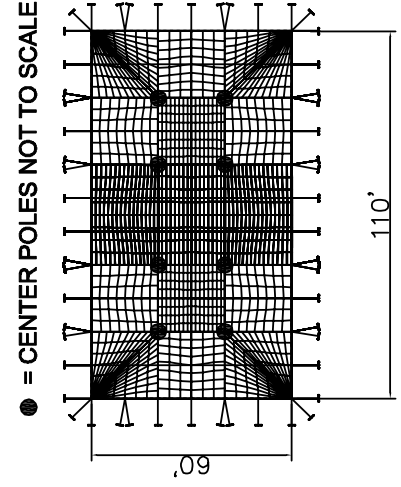

PLAN VIEW

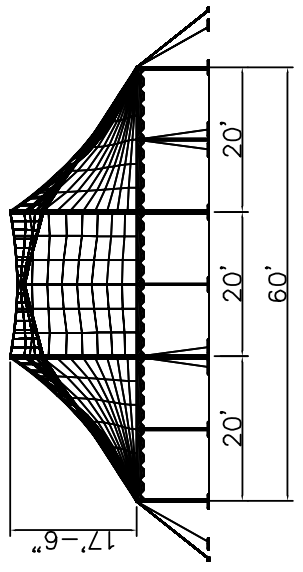

END VIEW

K:\cad files\Pole Tent\40-50-60 LEGEND\BUILDINGS\60'60X110X20-30X10.dwg, 12/29/2010 8:52:49 AM, pdfFactory

AZTEC TENTS 594 COLLEEN ST. TORRANCE, CA 90503 (408) 208-0887 - FAX (408) 208-0722 TTR		DATE: 09/14/05		PROJECT: -		DRAWING NO: 09/14/05	
STANDARD LEGEND POLE TENT 60' W X 90' L X 10' H		LPT		AZ60X90-60-80-100		REV: 0	

ALL DATA AND INFORMATION CONTAINED HEREIN IS UNCLASSIFIED EXCEPT TO THE EXTENT INDICATED OTHERWISE. THIS DOCUMENT IS CONFIDENTIAL AND PROPRIETARY. THE INFORMATION IS FOR YOUR USE ONLY AND IS NOT TO BE REPRODUCED OR TRANSMITTED IN ANY FORM OR BY ANY MEANS, ELECTRONIC OR MECHANICAL, INCLUDING PHOTOCOPYING, RECORDING, OR BY ANY INFORMATION STORAGE AND RETRIEVAL SYSTEM. THE INFORMATION IS PROVIDED AS IS WITHOUT WARRANTY OF ANY KIND, INCLUDING MERCHANTABILITY AND FITNESS FOR A PARTICULAR PURPOSE. YOU AGREE TO HOLD THE PROVIDER HARMLESS FOR ANY AND ALL DAMAGES, INCLUDING REASONABLE ATTORNEY'S FEES, THAT MAY BE INCURRED BY YOU AS A RESULT OF YOUR USE OF THIS DOCUMENT.

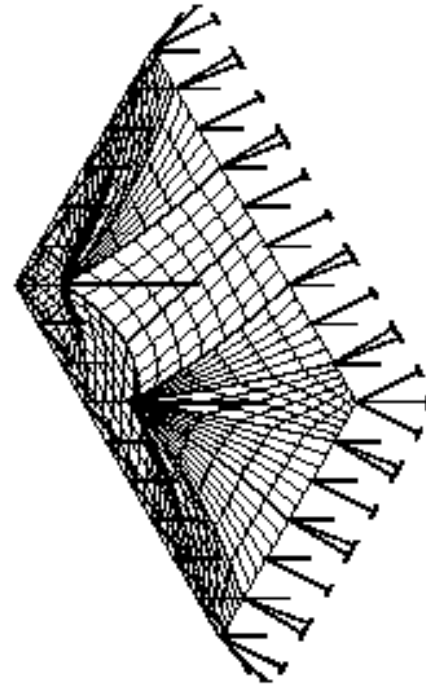

ISOMETRIC ELEVATION

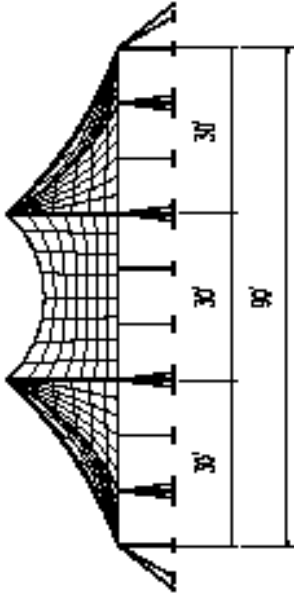

SIDE ELEVATION

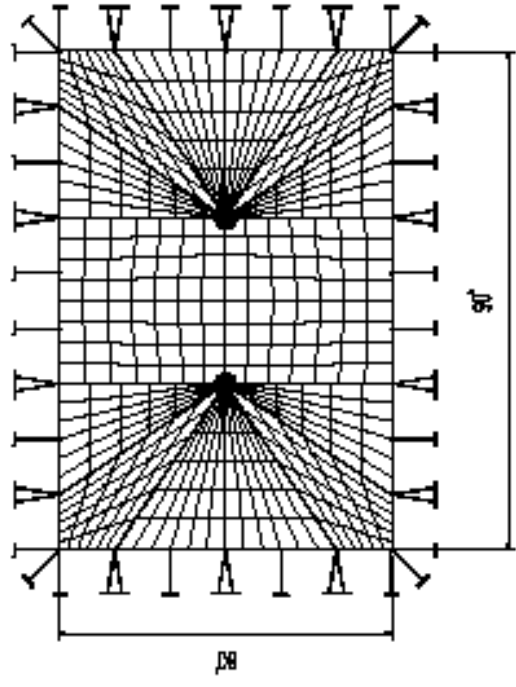

PLAN ELEVATION

● = CENTER POLES NOT TO SCALE

- LEGEND 60-80-100-120
60' x 90' MIDDLE COMPLETE, 3PC.
- (2) 60'x60' ENDS, 6PC.
 - (1) 60'x30' MIDDLE, 3PC.
 - (2) 6" ALUM. 2PC. CENTER POLE (8'L 28'-6" / 10'L 30'-6")
 - (30) 2-1/2" ALUM. SIDE POLE (8'L / 10'L)
 - (52) STAKE BAR w/ WEB RATCHET ASSEMBLY
 - (156) DBL. HEADED STAKES

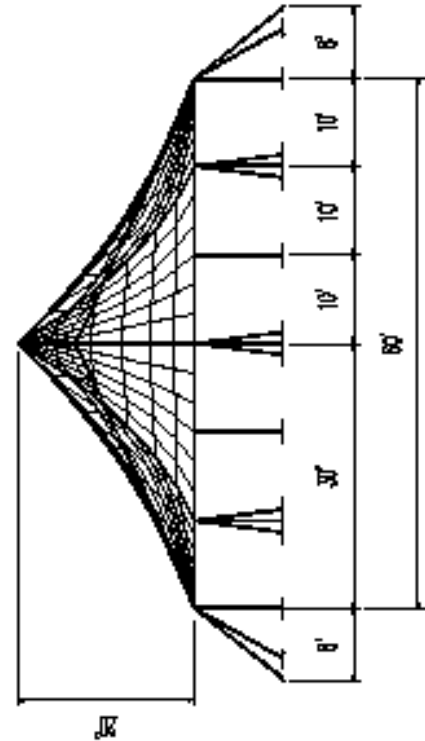

FRONT ELEVATION

STANDARD		AZ-B015010-LEGEND POLE 1		BD-80-100		AZ-B015010-LEGEND POLE 1	
STANDARD LEGEND POLE TENT		80'W x 150'L x 10'H 30' MIDDLES		TTR		09/16/05	
AZTEC		3000 COLLEGE ST. TORRANCE, CA 90503		CM		-	
AZTEC		3000 COLLEGE ST. TORRANCE, CA 90503		TTR		09/16/05	
AZTEC		3000 COLLEGE ST. TORRANCE, CA 90503		TTR		09/16/05	

ALL DATA AND INFORMATION CONTAINED IN OR DERIVED FROM THIS DOCUMENT IS CONFIDENTIAL AND PROPRIETARY INFORMATION OF AZTEC TENTS AND ALL RIGHTS THEREIN ARE RESERVED. NO PART OF THIS DOCUMENT MAY BE REPRODUCED OR TRANSMITTED IN ANY FORM OR BY ANY MEANS, ELECTRONIC OR MECHANICAL, INCLUDING PHOTOCOPYING, RECORDING, OR BY ANY INFORMATION STORAGE AND RETRIEVAL SYSTEM. THE USER AGREES THAT THE INFORMATION CONTAINED HEREIN IS PROVIDED AS IS WITHOUT WARRANTY OF ANY KIND, AND WILL NOT BE USED FOR ANY PURPOSE FOR WHICH IT WAS NOT DESIGNED. THE USER RELEASES AND AGREES TO HOLD AZTEC TENTS HARMLESS FROM AND IN DEFENSE OF ALL SUCH DAMAGES, INCLUDING REASONABLE ATTORNEY'S FEES AND COSTS TO BE INCURRED BY AZTEC TENTS IN CONNECTION WITH THE PROVISION OF THIS DOCUMENT.

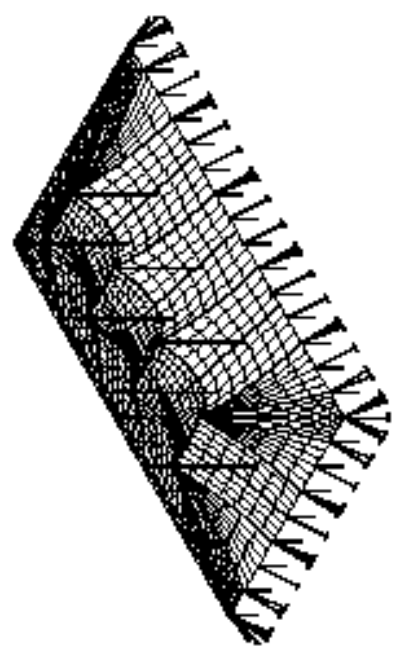

ISOMETRIC ELEVATION

LEGEND 60-80-100-120
80' x 150' MIDDLE COMPLETE, 3PC.

- {2} 80'x60' ENDS, 6PC.
- {3} 80'x30' MIDDLES, 3PC.
- {8} 6" ALUM. 2PC. CENTER POLE (8'L 28'-6" / 10'L 30'-6")
- {46} 2-1/2" ALUM. SIDE POLE (8'L / 10'L)
- {102} STAKE BAR w/ WEB RATCHET ASSEMBLY
- {306} DBL. HEADED STAKES

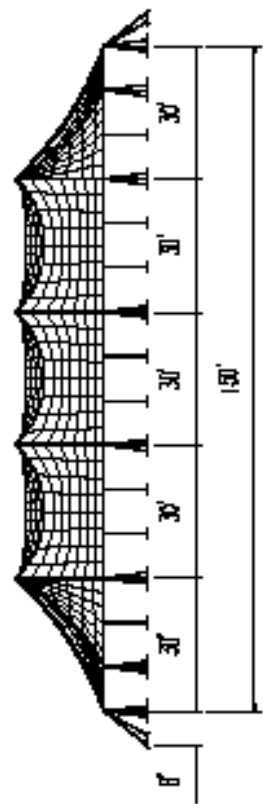

SIDE ELEVATION

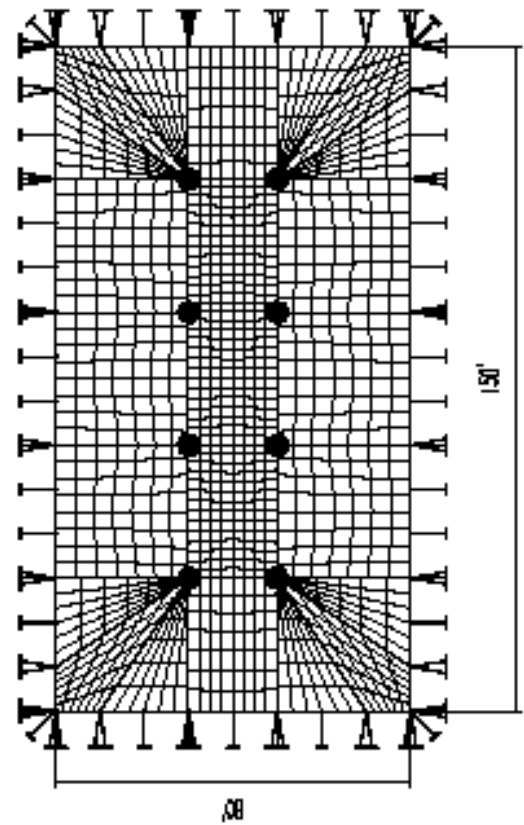

PLAN ELEVATION

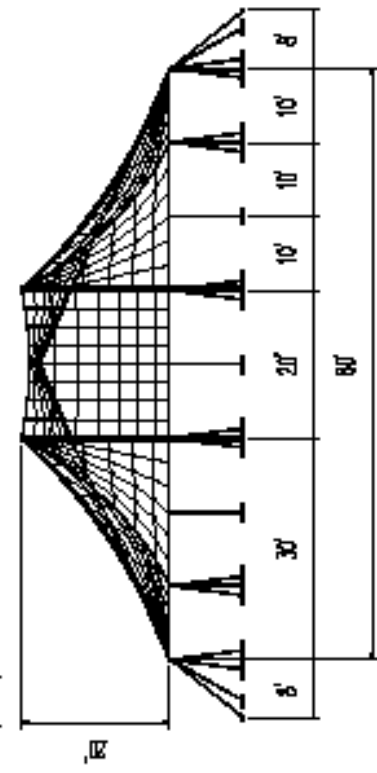

FRONT ELEVATION

AZT\40120\XXXX		DDDDDD TITLE	-	95-18-2006	LEGEND	AZ-100 X 90 X 10- LEGEND 0
ALL DATA AND INFORMATION CONTAINED IN OR DERIVED BY THIS DOCUMENT IS CONFIDENTIAL AND PROPRIETARY INFORMATION OF AZTEC TENTS AND ALL RIGHTS THEREIN ARE RESERVED BY AZTEC TENTS. THE INFORMATION AND PROGRAMS ARE PROVIDED AS IS WITHOUT WARRANTY OF ANY KIND. THE USER AGREES THAT THE MATERIAL AND INFORMATION CONTAINED HEREIN IS HELD IN CONFIDENCE AND IS NOT TO BE DISCLOSED OR REPRODUCED WITHOUT WRITING FROM AZTEC TENTS. ANY REPRODUCTION OR TRANSMISSION OF THIS DOCUMENT IS STRICTLY PROHIBITED. CONTACT: (800) 888-2888 - FAX: (714) 361-8012		CM		TTR	LEGEND 60-80-100 / STANDARD 100'W X 90'L X 10' LEGS	
AZTEC		STANDARD				

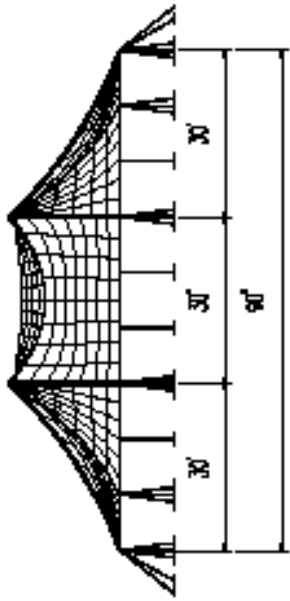

SIDE VIEW

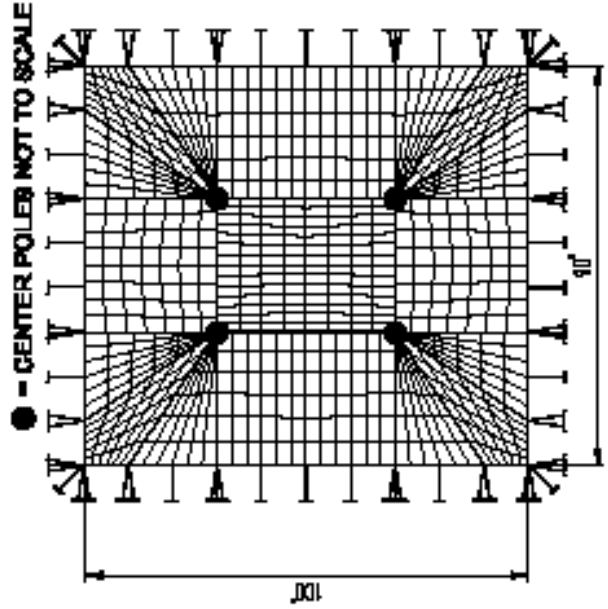

PLAN VIEW

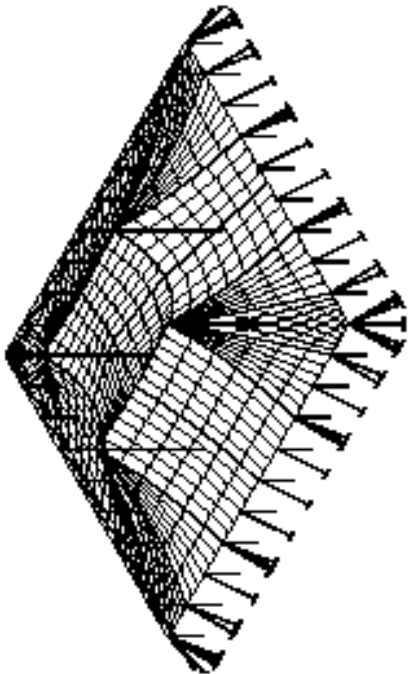

ISOMETRIC VIEW

LEGEND 60-80-100-120
100' x 90'

- (2) 100'x30' ENDS, 4PC.
- (1) 100'x30' MIDDLE, 2PC.
- (4) 6" ALUM. 2PC. CENTER POLE (8'L 28'-8" / 10'L 30'-8")
- (36) 2-1/2" ALUM. SIDE POLE (8'L / 10'L)
- (90) STAKE BAR W/ 2" WEB RATCHET ASSEMBLY
- (270) 1" X 42" DOUBLE HEADED STAKES

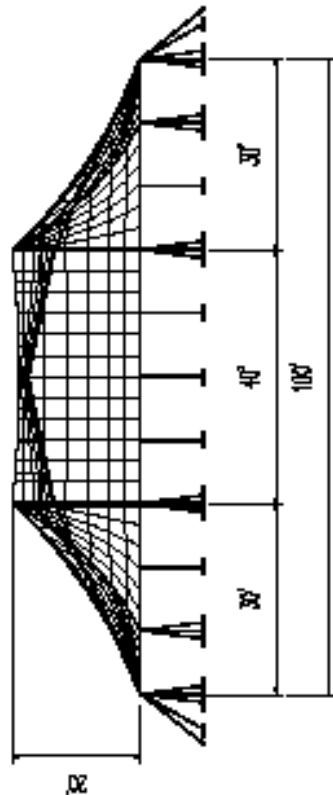

END VIEW

AZ-POLE TENT - DETAILS		07/05/05		070505 1235		60-80-100 LEGEND STAKE DET	
REV	DRAWING NUMBER	DATE	CHECKED	ENGINEER	ALL DATA AND INFORMATION CONTAINED IN OR DISCLOSED BY THIS DOCUMENT IS CONFIDENTIAL AND PROPRIETARY AND ALL RIGHTS THEREIN ARE EXPRESSLY RESERVED. INFORMATION OF AZTEC TENT AND EVENT INC. BY ACCEPTING THIS MATERIAL, THE RECIPIENT AGREES THAT THIS MATERIAL AND INFORMATION CONTAINED THEREIN IS HELD IN CONFIDENCE AND IN TRUST AND WILL NOT BE COPIED, REPRODUCED OR IN PART EXCEPT TO MEET THE SPECIFIC PURPOSE FOR WHICH IT WAS DELIVERED.		
		07/05/05	-	CM	540 HAWAII AVE. TORRANCE, CA, 90503 (800) 258-7368 - (310) 328-5060 - FAX (310) 328-5356		
		KT					
PART DESCRIPTION				POLY TENT / STANDARD			
CODE				STAKE BAR ASSEMBLY DETAILS			
SIZE				STANDARD			

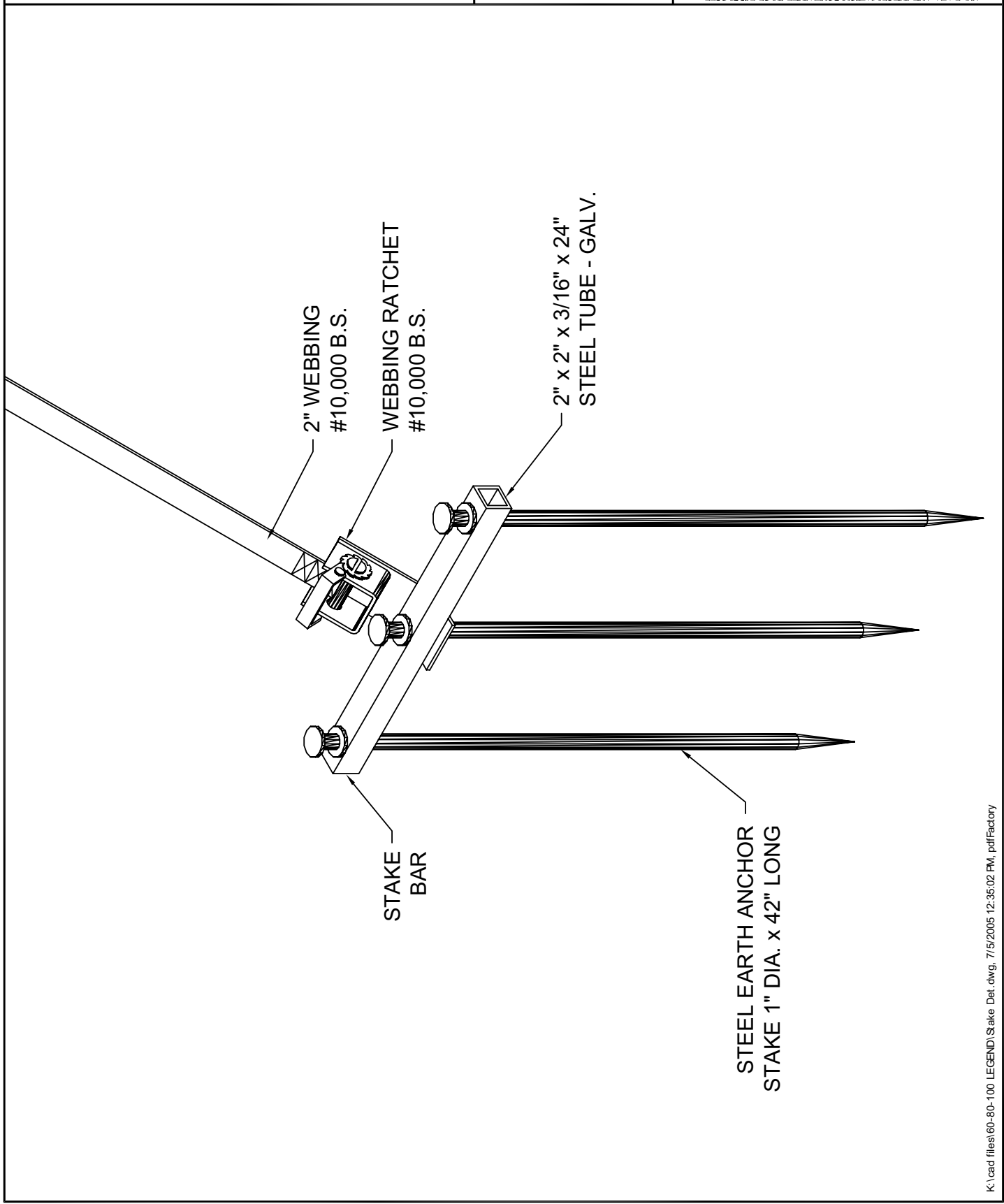

K:\cad files\60-80-100 LEGEND\Stake Det.dwg, 7/5/2005 12:35:02 PM, pdfFactory

Legend Series 40x Layout

L = LACELINE
G = GROMMET

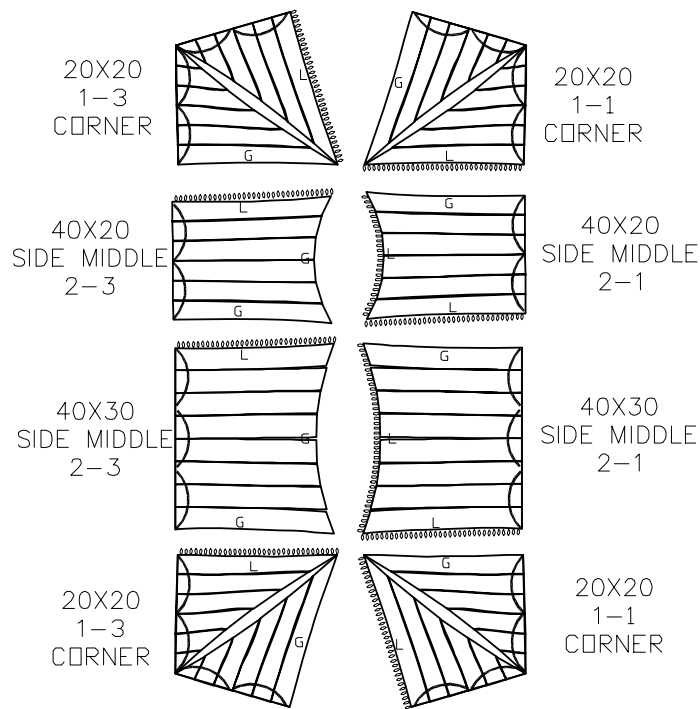

OUTSIDE

ALL DATA AND INFORMATION CONTAINED IN OR DISCLOSED BY THIS DOCUMENT IS CONFIDENTIAL AND PROPRIETARY INFORMATION OF AZTEC TENT AND EVENT INC. AND ALL RIGHTS THEREIN ARE EXPRESSLY RESERVED. BY ACCEPTING THIS MATERIAL THE RECIPIENT AGREES THAT THIS MATERIAL AND INFORMATION CONTAINED THEREIN IS HELD IN CONFIDENCE AND IN TRUST AND WILL NOT BE COPIED, REPRODUCED WHOLE OR IN PART, NOR ITS CONTENTS REVEALED IN ANY MANNER TO OTHERS, EXCEPT TO MEET THE SPECIFIC PURPOSE FOR WHICH IT WAS DELIVERED.



540 HAWAII AVE. TORRANCE, CA. 90503
(800) 258-7368 - (310) 328-5080 - FAX (310) 328-5356

STANDARD
PATTERN LOCATIONS

40-50-60 LEGEND POLE / STANDARD

ENGINEER	DRAWN	PART DESCRIPTION	CODE	SIZE	DRAWING NUMBER	REV
CM	AK					
CHECKED	DATE			AZ-40-50-60- PATTERNS		0
-	11-04-05					

40-50-60\PATTERNS 020609 1740

Legend Series 50X Layout

L = LACELINE
G = GROMMET

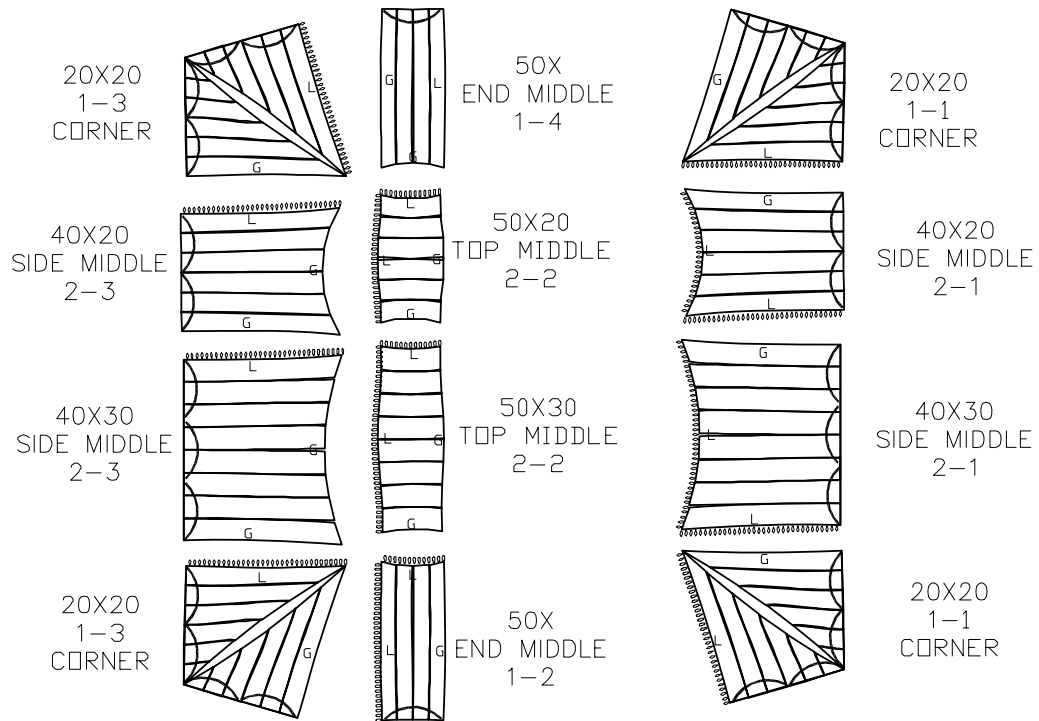

OUTSIDE

<p>ALL DATA AND INFORMATION CONTAINED IN OR DISCLOSED BY THIS DOCUMENT IS CONFIDENTIAL AND PROPRIETARY INFORMATION OF AZTEC TENT AND EVENT INC. AND ALL RIGHTS THEREIN ARE EXPRESSLY RESERVED. BY ACCEPTING THIS MATERIAL THE RECIPIENT AGREES THAT THIS MATERIAL AND INFORMATION CONTAINED THEREIN IS HELD IN CONFIDENCE AND IN TRUST AND WILL NOT BE COPIED, REPRODUCED WHOLE OR IN PART, NOR ITS CONTENTS REVEALED IN ANY MANNER TO OTHERS, EXCEPT TO MEET THE SPECIFIC PURPOSE FOR WHICH IT WAS DELIVERED.</p>	 <p>540 HAWAII AVE. TORRANCE, CA. 90503 (800) 258-7388 - (310) 328-5060 - FAX (310) 328-5356</p>	<p>STANDARD PATTERN LOCATIONS</p>						
		<p>40-50-60 LEGEND POLE / STANDARD</p>						
<p>40-50-60\PATTERNS</p>	<p>020609 0950</p>	<p>ENGINEER CM CHECKED -</p>	<p>DRAWN AK DATE 11-04-05</p>	<p>PART DESCRIPTION _____</p>	<p>CODE AZ-40-50-60-</p>	<p>SIZE PATTERNS</p>	<p>DRAWING NUMBER 0</p>	<p>REV 0</p>

Legend Series 60x TP Layout

L = LACELINE
G = GROMMET

20X20
1-3
CORNER

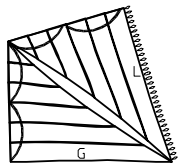

60X
END MIDDLE
1-4

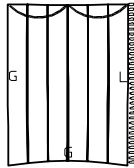

20X20
1-1
CORNER

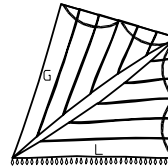

40X20
SIDE MIDDLE
2-3

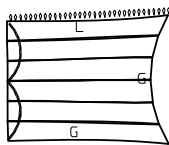

60X20
TOP MIDDLE
2-2

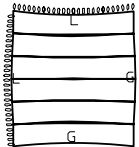

40X20
SIDE MIDDLE
2-1

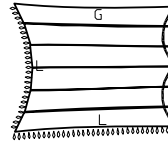

40X30
SIDE MIDDLE
2-3

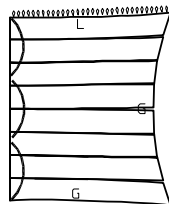

60X30
TOP MIDDLE
2-2

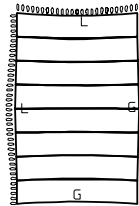

40X30
SIDE MIDDLE
2-1

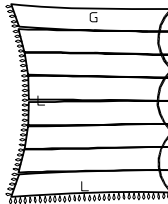

20X20
1-3
CORNER

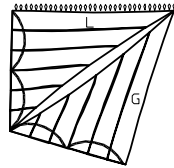

60X
END MIDDLE
1-2

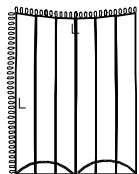

20X20
1-1
CORNER

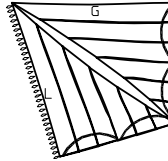

OUTSIDE

ALL DATA AND INFORMATION CONTAINED IN OR DISCLOSED BY THIS DOCUMENT IS CONFIDENTIAL AND PROPRIETARY INFORMATION OF AZTEC TENT AND EVENT INC. AND ALL RIGHTS THEREIN ARE EXPRESSLY RESERVED. BY ACCEPTING THIS MATERIAL THE RECIPIENT AGREES THAT THIS MATERIAL AND INFORMATION CONTAINED THEREIN IS HELD IN CONFIDENCE AND IN TRUST AND WILL NOT BE COPIED, REPRODUCED WHOLE OR IN PART, NOR ITS CONTENTS REVEALED IN ANY MANNER TO OTHERS, EXCEPT TO MEET THE SPECIFIC PURPOSE FOR WHICH IT WAS DELIVERED.



540 HAWAII AVE. TORRANCE, CA. 90503
(800) 258-7388 - (310) 328-5080 - FAX (310) 328-5356

STANDARD
PATTERN LOCATIONS

40-50-60 LEGEND POLE / STANDARD

ENGINEER	CM	DRAWN	AK	PART DESCRIPTION	CODE	SIZE	DRAWING NUMBER	REV
40-50-60\ PATTERNS	020609 0950	CHECKED	-	DATE	11-04-05		AZ-40-50-60- PATTERNS	1

Legend Series 60x Layout

L = LACELINE
G = GROMMET

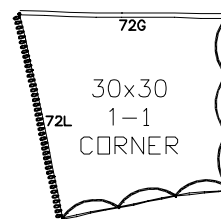
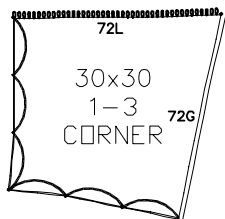
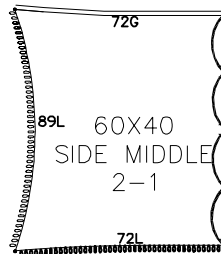
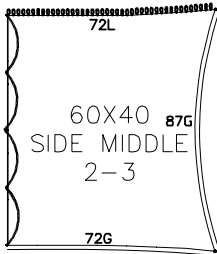
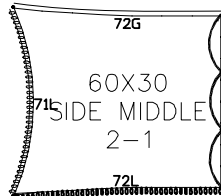
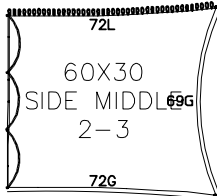
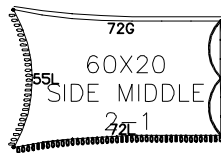
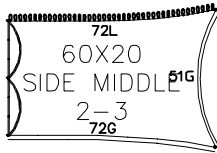
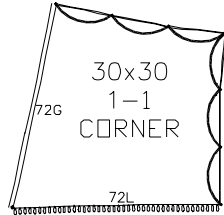
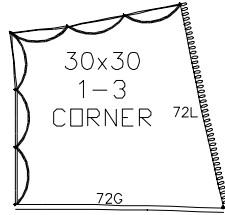

OUTSIDE

ALL DATA AND INFORMATION CONTAINED IN OR DISCLOSED BY THIS DOCUMENT IS CONFIDENTIAL AND PROPRIETARY INFORMATION OF AZTEC TENT AND EVENT INC. AND ALL RIGHTS THEREIN ARE EXPRESSLY RESERVED. BY ACCEPTING THIS MATERIAL THE RECIPIENT AGREES THAT THIS MATERIAL AND INFORMATION CONTAINED THEREIN IS HELD IN CONFIDENCE AND IN TRUST AND WILL NOT BE COPIED, REPRODUCED WHOLE OR IN PART, NOR ITS CONTENTS REVEALED IN ANY MANNER TO OTHERS, EXCEPT TO MEET THE SPECIFIC PURPOSE FOR WHICH IT WAS DELIVERED.



540 HAWAII AVE. TORRANCE, CA. 90503
(800) 228-7388 - (310) 328-5080 - FAX (310) 328-5356

ENGINEER CM DRAWN TTR
CHECKED - DATE 11-04-05

STANDARD
PATTERN LOCATIONS

60-80-100 LEGEND POLE / STANDARD

PART DESCRIPTION	CODE	SIZE	DRAWING NUMBER	REV
_____	AZ-60-80-100-	PATTERNS	0	

60-80-100\PATTERNS 030306 1740

Legend Series 80x Layout

L = LACELINE
G = GROMMET

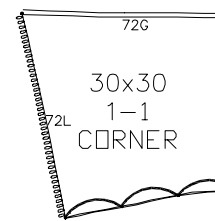
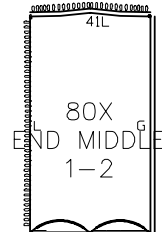
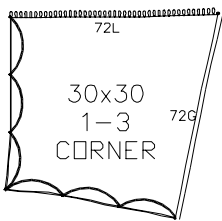
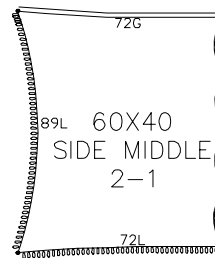
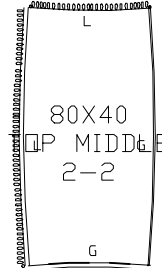
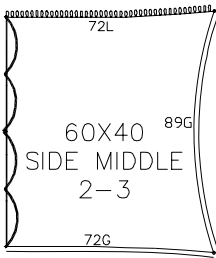
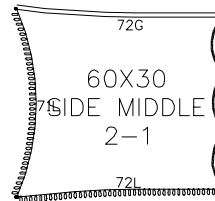
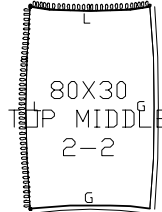
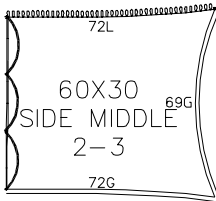
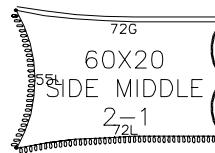
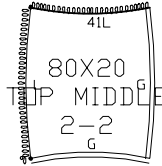
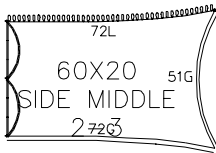
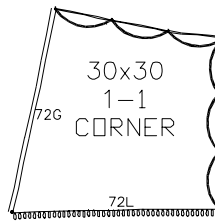
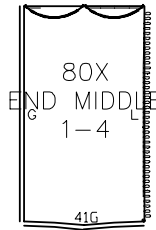
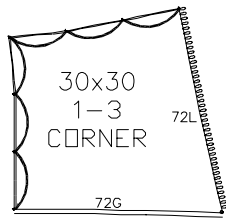

OUTSIDE

ALL DATA AND INFORMATION CONTAINED IN OR DISCLOSED BY THIS DOCUMENT IS CONFIDENTIAL AND PROPRIETARY INFORMATION OF AZTEC TENT AND EVENT INC. AND ALL RIGHTS THEREIN ARE EXPRESSLY RESERVED. BY ACCEPTING THIS MATERIAL THE RECIPIENT AGREES THAT THIS MATERIAL AND INFORMATION CONTAINED THEREIN IS HELD IN CONFIDENCE AND IN TRUST AND WILL NOT BE COPIED, REPRODUCED WHOLE OR IN PART, NOR ITS CONTENTS REVEALED IN ANY MANNER TO OTHERS, EXCEPT TO MEET THE SPECIFIC PURPOSE FOR WHICH IT WAS DELIVERED.



540 HAWAII AVE. TORRANCE, CA. 90503
(800) 258-7388 - (310) 328-5080 - FAX (310) 328-5356

STANDARD PATTERN LOCATIONS

60-80-100 LEGEND POLE / STANDARD

PART DESCRIPTION	CODE	SIZE	DRAWING NUMBER	REV
60-80-100 PATTERNS	030306	1740		
CHECKED	-	DATE	11-04-05	
			AZ-60-80-100- PATTERNS	0

Legend Series 100x Layout

L = LACELINE
G = GROMMET

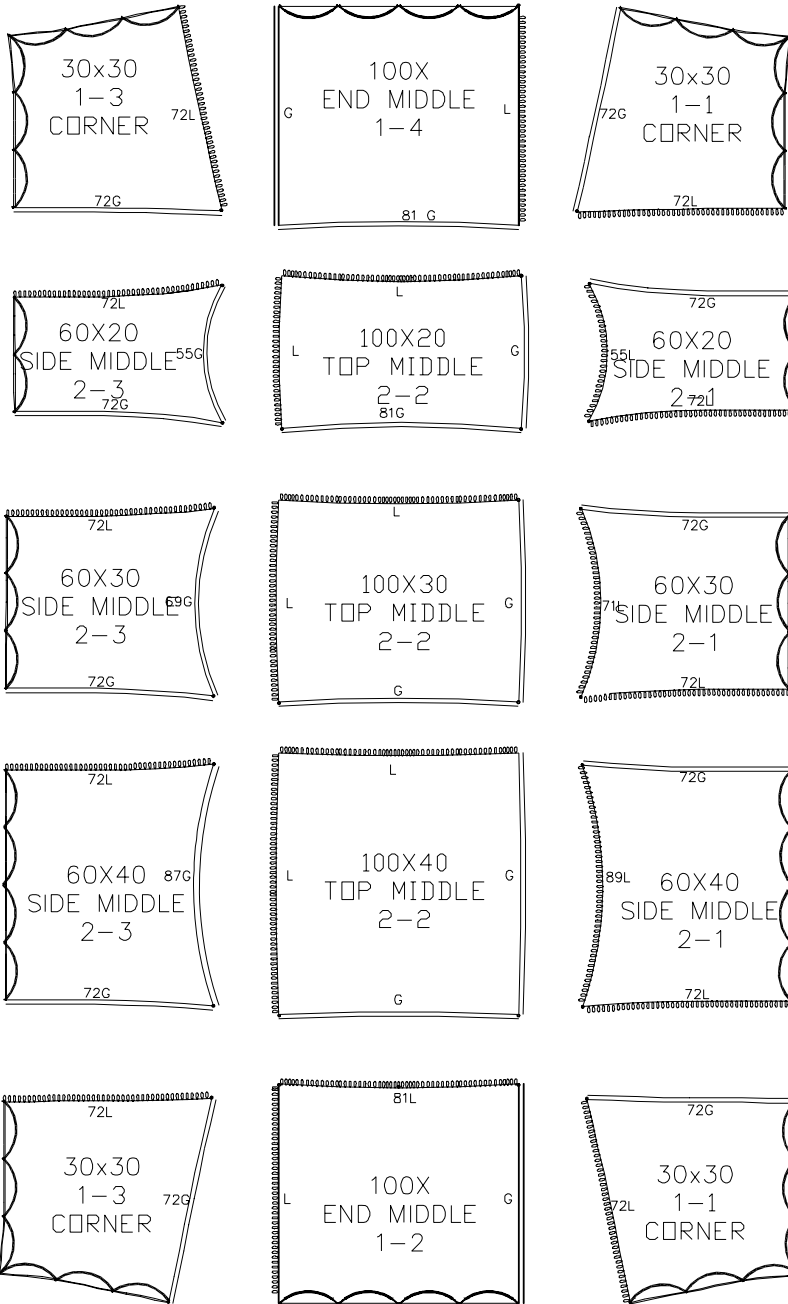

OUTSIDE

ALL DATA AND INFORMATION CONTAINED IN OR DISCLOSED BY THIS DOCUMENT IS CONFIDENTIAL AND PROPRIETARY INFORMATION OF AZTEC TENT AND EVENT INC. AND ALL RIGHTS THEREIN ARE EXPRESSLY RESERVED. BY ACCEPTING THIS MATERIAL THE RECIPIENT AGREES THAT THIS MATERIAL AND INFORMATION CONTAINED THEREIN IS HELD IN CONFIDENCE AND IN TRUST AND WILL NOT BE COPIED, REPRODUCED WHOLE OR IN PART, NOR ITS CONTENTS REVEALED IN ANY MANNER TO OTHERS, EXCEPT TO MEET THE SPECIFIC PURPOSE FOR WHICH IT WAS DELIVERED.



540 HAWAII AVE. TORRANCE, CA. 90503
(800) 258-7368 - (310) 328-5080 - FAX (310) 328-5356

STANDARD
PATTERN LOCATIONS

60-80-100 LEGEND POLE / STANDARD

60-80-100 PATTERNS		ENGINEER	CM	DRAWN	TTR	PART DESCRIPTION	CODE	SIZE	DRAWING NUMBER	REV
030306 1740		CHECKED	-	DATE	11-04-05	---		AZ-60-80-100-	PATTERNS	1

Legend Series 120x Layout

L = LACELINE
G = GROMMET

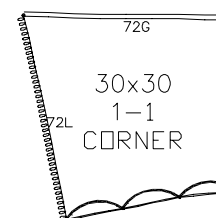
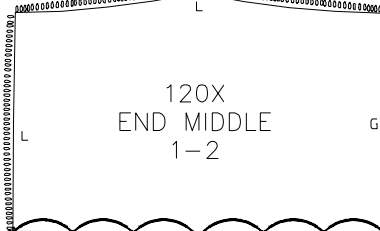
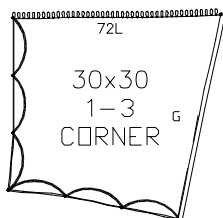
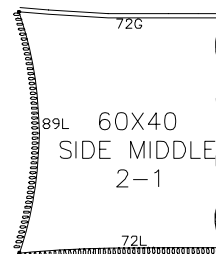
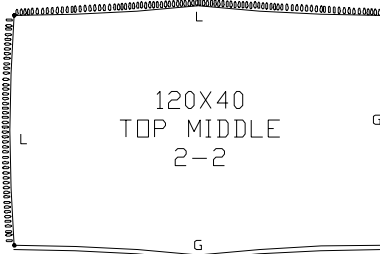
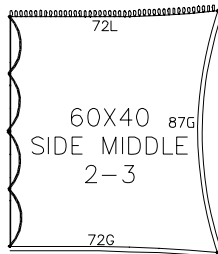
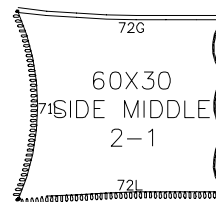
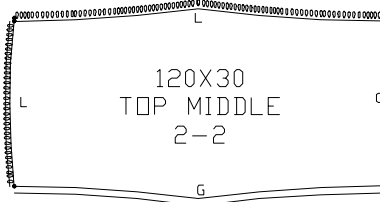
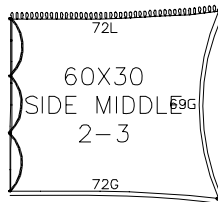
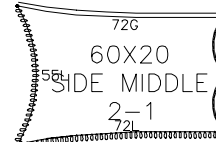
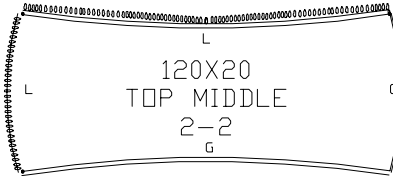
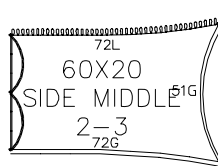
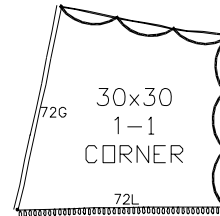
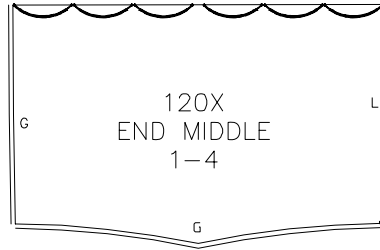
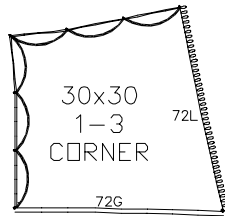

OUTSIDE

ALL DATA AND INFORMATION CONTAINED IN OR DISCLOSED BY THIS DOCUMENT IS CONFIDENTIAL AND PROPRIETARY INFORMATION OF AZTEC TENT AND EVENT INC. AND ALL RIGHTS THEREIN ARE EXPRESSLY RESERVED. BY ACCEPTING THIS MATERIAL THE RECIPIENT AGREES THAT THIS MATERIAL AND INFORMATION CONTAINED THEREIN IS HELD IN CONFIDENCE AND IN TRUST AND WILL NOT BE COPIED, REPRODUCED WHOLE OR IN PART, NOR ITS CONTENTS REVEALED IN ANY MANNER TO OTHERS, EXCEPT TO MEET THE SPECIFIC PURPOSE FOR WHICH IT WAS DELIVERED.

AZTEC
540 HAWAII AVE. TORRANCE, CA. 90503
(800) 258-7368 - (310) 328-5080 - FAX (310) 328-5356

STANDARD
PATTERN LOCATIONS

60-80-100 LEGEND POLE / STANDARD

60-80-100\PATTERNS 030306 1740

ENGINEER	CM	DRAWN	TTR
CHECKED	-	DATE	11-04-05

PART DESCRIPTION	CODE	SIZE	DRAWING NUMBER	REV
_____	AZ-60-80-100-	PATTERNS	0	

Parts Listing

Item	Item No.	Weight lbs
*LGD 20x20 Corner 1-1 UW	Z322Z00010B/O	82
*LGD 20x20 Corner 1-3 UW	Z322Z00020B/O	82
*LGD Side Mid 1/2 40x20 2-1 UW	Z322Z00030B/O	86
*LGD Side Mid 1/2 40x20 2-3 UW	Z322Z00040B/O	86
*LGD Side Mid 1/2 40x30 2-1 UW	Z322Z00050B/O	128
*LGD Side Mid 1/2 40x30 2-3 UW	Z322Z00060B/O	128
*LGD End Mid 1/2 50x 1-2 UW	Z322Z00070B/O	45
*LGD End Mid 1/2 50x 1-4 UW	Z322Z00080B/O	45
*LGD Top Mid 50x20 2-2 UW	Z322Z00090B/O	41
*LGD Top Mid 50x30 2-2 UW	Z322Z00100B/O	62
*LGD End Mid 1/2 60x1-2 UW	Z322Z00110B/O	86
*LGD End Mid 1/2 60x1-4 UW	Z322Z00120B/O	86
*LGD Top Mid 60x20 2-2 UW	Z322Z00130B/O	82
*LGD Top Mid 60x30 2-2 UW	Z322Z00140B/O	123
*LGD 30x30 Corner 1-1 UW	Z324Z00010B/O	237
*LGD 30x30 Corner 1-3 UW	Z324Z00020B/O	237
*LGD Side Mid 1/2 60x20 2-1UW	Z324Z00030B/O	153
*LGD Side Mid 1/2 60x20 2-3UW	Z324Z00040B/O	153
*LGD Side Mid 1/2 60x30 2-1UW	Z324Z00050B/O	223
*LGD Side Mid 1/2 60x30 2-3UW	Z324Z00060B/O	223
*LGD Side Mid 1/2 60x40 2-1UW	Z324Z00070B/O	270
*LGD Side Mid 1/2 60x40 2-3UW	Z324Z00080B/O	270
*LGD End Mid 1/2 80x 1-2 UW	Z324Z00090B/O	153
*LGD End Mid 1/2 80x 1-4 UW	Z324Z00100B/O	153
*LGD Top Mid 80x20 2-2 UW	Z324Z00110B/O	74
*LGD Top Mid 80x30 2-2 UW	Z324Z00120B/O	111
*LGD Top Mid 80x40 2-2 UW	Z324Z00130B/O	155
*LGD End Mid 1/2 100x 1-2 UW	Z324Z00140B/O	270
*LGD End Mid 1/2 100x 1-4 UW	Z324Z00150B/O	270
*LGD Top Mid 100x20 2-2 UW	Z324Z00160B/O	156
*LGD Top Mid 100x30 2-2 UW	Z324Z00170B/O	198
*LGD Top Mid 100x40 2-2 UW	Z324Z00180B/O	244
2.5" SCH40 1pc Alum SP x 7'0"	Z3912.5SCH40X07	19
2.5" SCH40 1pc Alum SP x 8'0"	Z3912.5SCH40X08	21
2.5" SCH40 1pc Alum SP x 10'0"	Z3912.5SCH40X10	25
4" SCH40 2pc Legend CPx26'	Z3954SCH40X26	147
4" SCH40 2pc Legend CPx28'	Z3954SCH40X28	154
6" SCH40 2pc Legend CPx28'6"	Z3956SCH40X2806	153
6" SCH40 2pc Legend CPx30'6"	Z3956SCH40X3006	166
24" Stake Bar	Z39900300	8
Tens. Ratchet W/Plate (Only)	Z39900320	6
2" Web Guy x 20' (Only)	Z39900330	2
Rolling Skid Plate w/tire Only	Z39900350	56
Rolling Skid Plate - Base Only	Z39900360	32
Legend CP Bonnet	Z39900370	2
5/8" Polydac CP Jumper	Z39900430	3
5/8" Polydac Leg Jumper	Z39900460	3

If YOU can IMAGINE it... WE can BUILD it

www.aztectents.com

Aztec Tents

2665 Columbia Street
Torrance, CA 90503
Toll Free (800) 228-3687
Fax (310) 381-0722