

ISOMETRIC VIEW

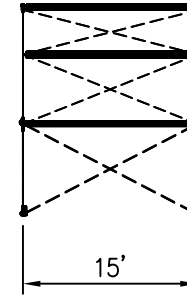

SIDE VIEW

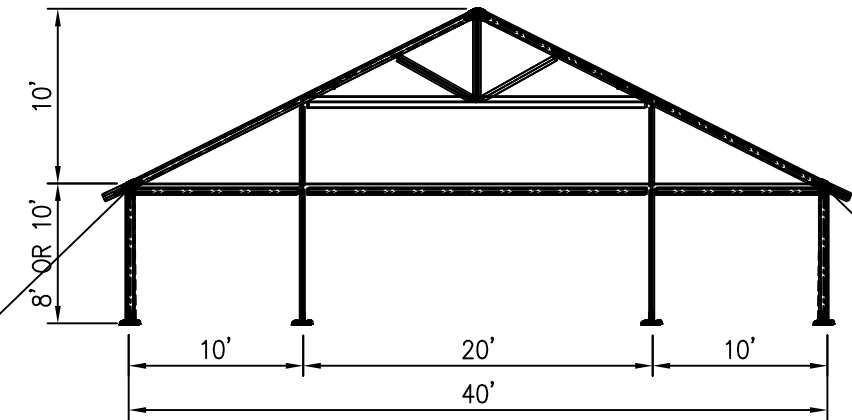

PLAN VIEW

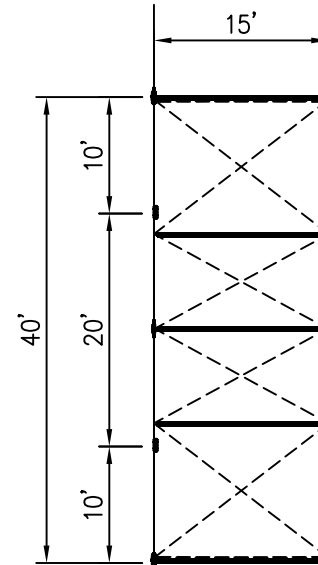

FRONT VIEW

ALL DATA AND INFORMATION CONTAINED IN OR DISCLOSED BY THIS DOCUMENT IS CONFIDENTIAL AND PROPRIETARY INFORMATION OF AZTEC TENTS AND ALL RIGHTS THEREIN ARE EXPRESSLY RESERVED. BY ACCEPTING THIS MATERIAL THE RECIPIENT AGREES THAT THIS MATERIAL AND INFORMATION CONTAINED THEREIN IS HELD IN CONFIDENCE AND IN TRUST AND WILL NOT BE COPIED, REPRODUCED WHOLE OR IN PART, NOR ITS CONTENTS REVEALED IN ANY MANNER TO OTHERS, EXCEPT TO MEET THE SPECIFIC PURPOSE FOR WHICH IT WAS DELIVERED.

AZTEC TENTS
 DESIGN & PRODUCTION
 2665 COLUMBIA ST. TORRANCE, CA. 90503
 (800) 228-3687 - FAX (310) 381-0722

TIMBERTRAC FRAME
 TIMBERTRAC FRAME TENT/STANDARD
 40' W X 15' L
 PART NUMBER: ZXXXXXXX

REVISION HISTORY			
REV#	DESCRIPTION	BY:	DATE:

CONFIDENTIAL

ENGINEER:	N/A	DATE:	1/5/2017
1 OF 1		DRAWN:	LYZ R.

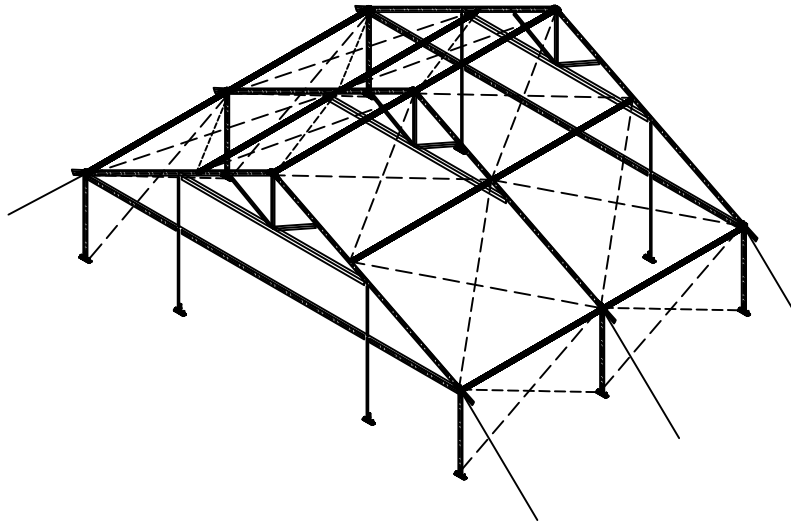

ISOMETRIC VIEW

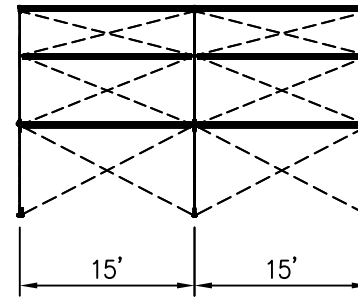

SIDE VIEW

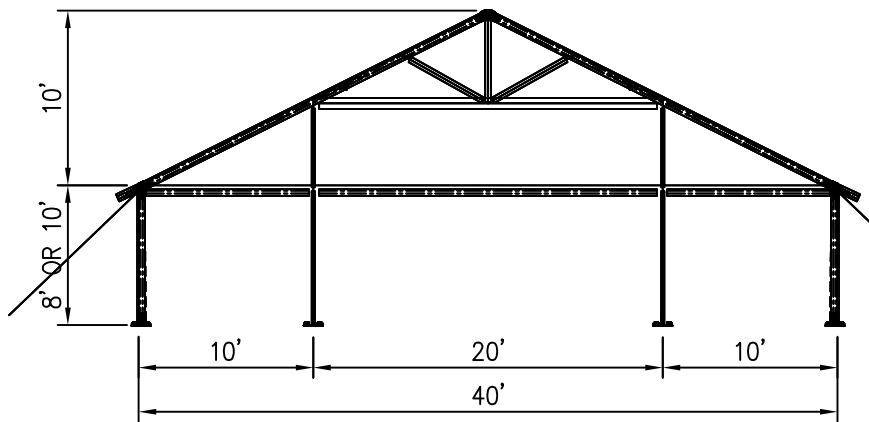

FRONT VIEW

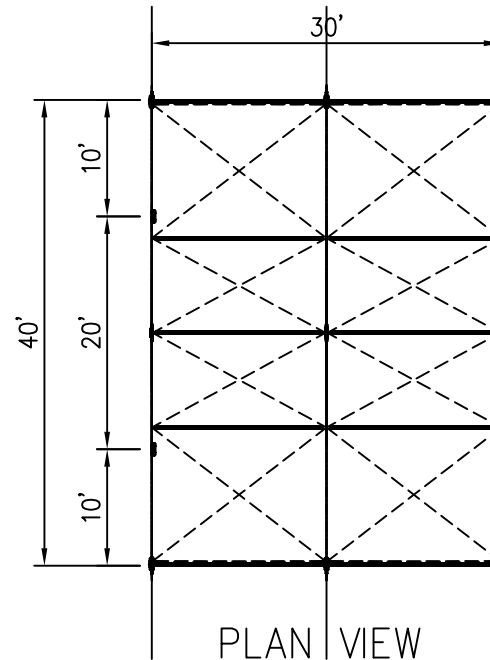

PLAN VIEW

ALL DATA AND INFORMATION CONTAINED IN OR DISCLOSED BY THIS DOCUMENT IS CONFIDENTIAL AND PROPRIETARY INFORMATION OF AZTEC TENTS AND ALL RIGHTS THEREIN ARE EXPRESSLY RESERVED. BY ACCEPTING THIS MATERIAL THE RECIPIENT AGREES THAT THIS MATERIAL AND INFORMATION CONTAINED THEREIN IS HELD IN CONFIDENCE AND IN TRUST AND WILL NOT BE COPIED, REPRODUCED WHOLE OR IN PART, NOR ITS CONTENTS REVEALED IN ANY MANNER TO OTHERS, EXCEPT TO MEET THE SPECIFIC PURPOSE FOR WHICH IT WAS DELIVERED.

AZTEC TENTS
 DESIGN & PRODUCTION
 2665 COLUMBIA ST. TORRANCE, CA. 90503
 (800) 228-3687 - FAX (310) 381-0722

TIMBERTRAC FRAME
 TIMBERTRAC FRAME TENT/STANDARD
 40' W X 30' L X 15' MIDDLE
 PART NUMBER: ZXXXXXXX

REVISION HISTORY			
DESCRIPTION	BY	DATE	

CONFIDENTIAL

ENGINEER:	N/A	DATE:	5/9/2016
		DRAWN:	HUGO.R

1 OF 1

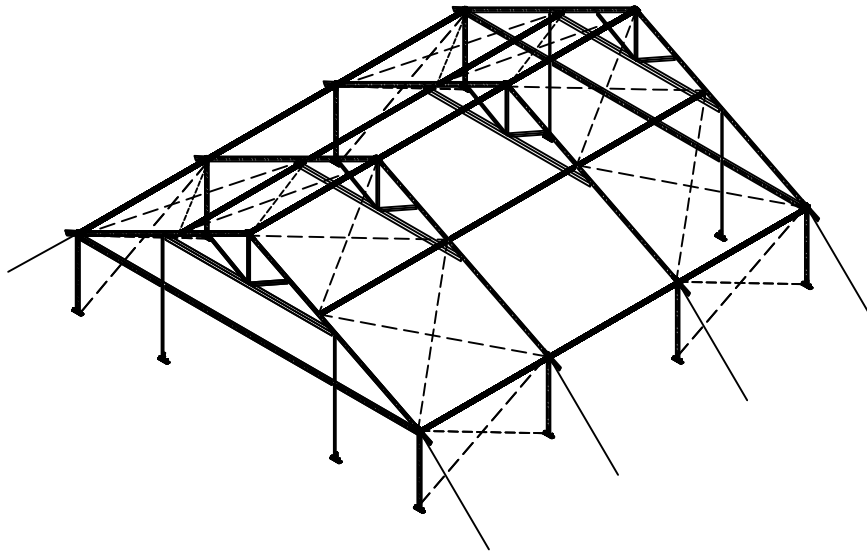

ISOMETRIC VIEW

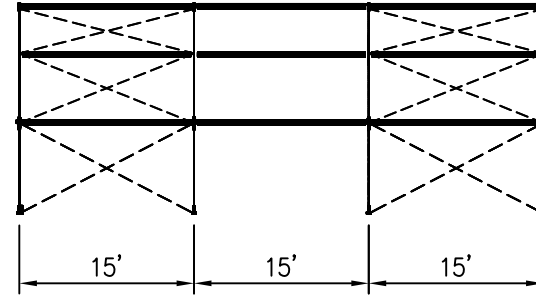

SIDE VIEW

40' X 45' TIMBERTRAC

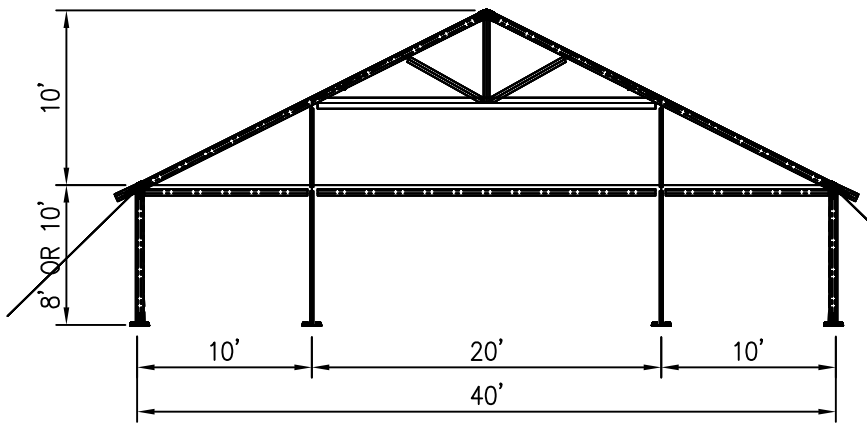

PLAN VIEW

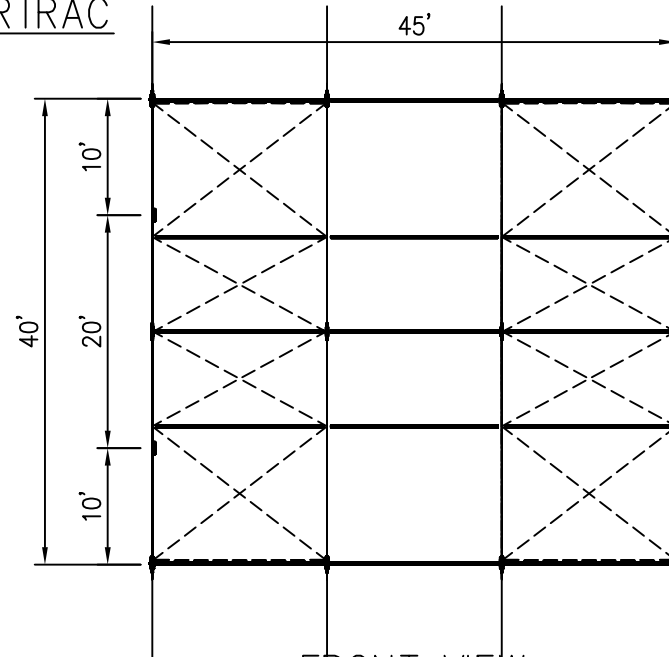

FRONT VIEW

ALL DATA AND INFORMATION CONTAINED IN OR DISCLOSED BY THIS DOCUMENT IS CONFIDENTIAL AND PROPRIETARY INFORMATION OF AZTEC TENTS AND ALL RIGHTS THEREIN ARE EXPRESSLY RESERVED. BY ACCEPTING THIS MATERIAL THE RECIPIENT AGREES THAT THIS MATERIAL AND INFORMATION CONTAINED THEREIN IS HELD IN CONFIDENCE AND IN TRUST AND WILL NOT BE COPIED, REPRODUCED WHOLE OR IN PART, NOR ITS CONTENTS REVEALED IN ANY MANNER TO OTHERS, EXCEPT TO MEET THE SPECIFIC PURPOSE FOR WHICH IT WAS DELIVERED.

AZTEC TENTS
 DESIGN & PRODUCTION
 2665 COLUMBIA ST. TORRANCE, CA. 90503
 (800) 228-3687 - FAX (310) 381-0722

TIMBERTRAC FRAME
 TIMBERTRAC FRAME TENT/STANDARD
 40' W X 45' L X 15' MIDDLE
 PART NUMBER: ZXXXXXXX

REVISION HISTORY			
REV#	DESCRIPTION	BY:	DATE:

SALES

ENGINEER:	N/A	DATE:	1/5/2017
DRAWN:	LYZ R.		

1 OF 1

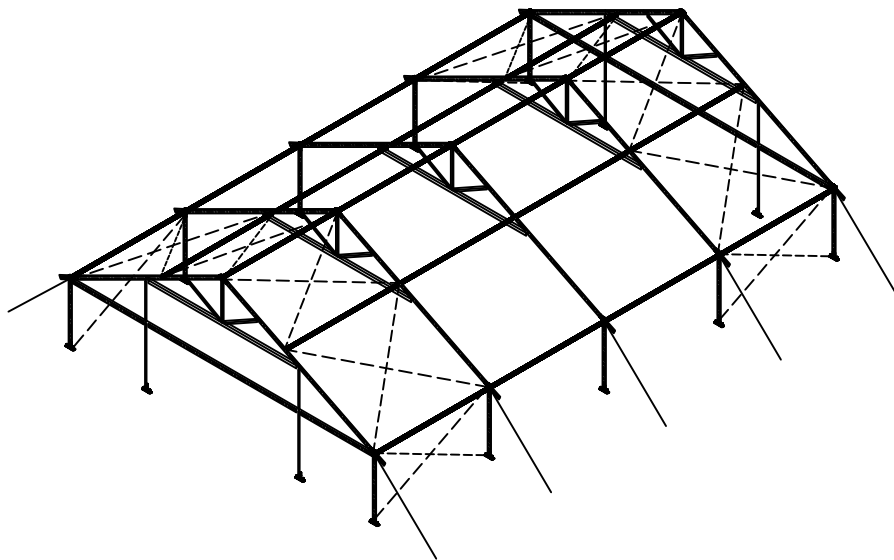

ISOMETRIC VIEW

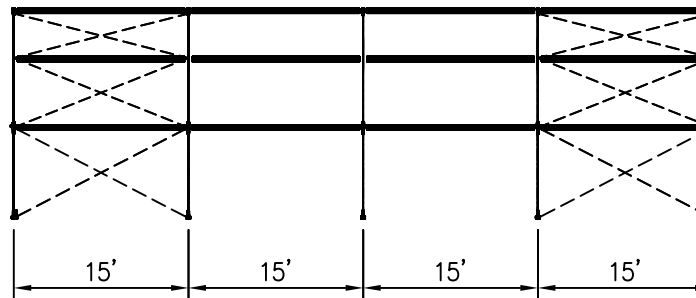

SIDE VIEW

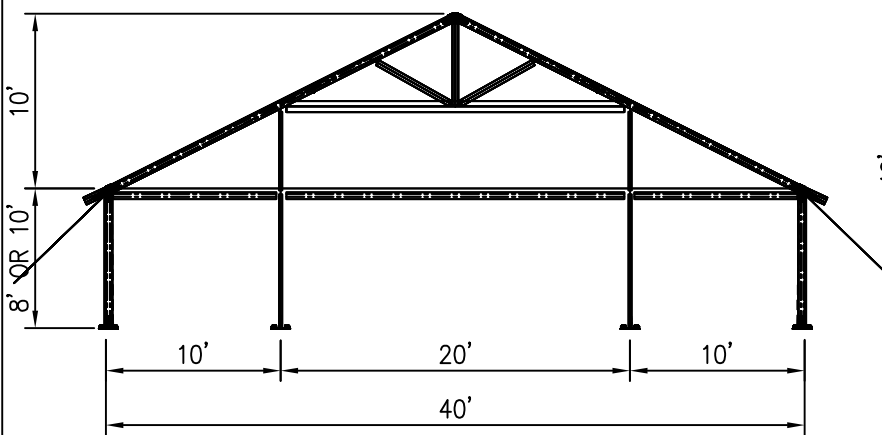

PLAN VIEW

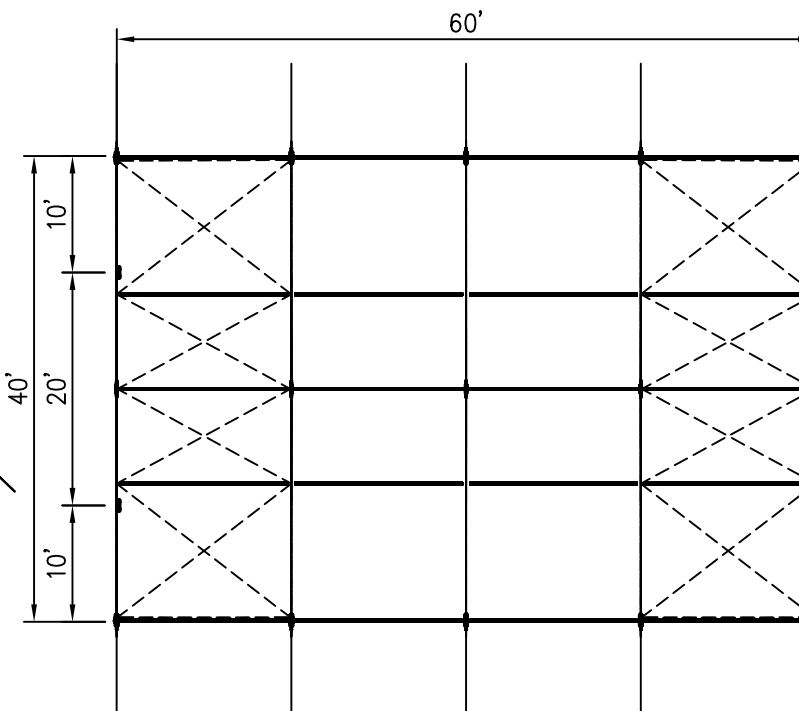

FRONT VIEW

ALL DATA AND INFORMATION CONTAINED IN OR DISCLOSED BY THIS DOCUMENT IS CONFIDENTIAL AND PROPRIETARY INFORMATION OF AZTEC TENTS AND ALL RIGHTS THEREIN ARE EXPRESSLY RESERVED. BY ACCEPTING THIS MATERIAL THE RECIPIENT AGREES THAT THIS MATERIAL AND INFORMATION CONTAINED THEREIN IS HELD IN CONFIDENCE AND IN TRUST AND WILL NOT BE COPIED, REPRODUCED WHOLE OR IN PART, NOR ITS CONTENTS REVEALED IN ANY MANNER TO OTHERS, EXCEPT TO MEET THE SPECIFIC PURPOSE FOR WHICH IT WAS DELIVERED.

AZTEC TENTS
 DESIGN & PRODUCTION
 2665 COLUMBIA ST. TORRANCE, CA. 90503
 (800) 228-3687 - FAX (310) 381-0722

TIMBERTRAC FRAME
 TIMBERTRAC FRAME TENT/STANDARD
 40' W X 60' L X 15' MIDDLE
 PART NUMBER: ZXXXXXXX

REVISION HISTORY			
DESCRIPTION	BY	DATE	

CONFIDENTIAL

ENGINEER:	N/A	DATE:	5/9/2016
DRAWN:			HUGO.R

1 OF 1

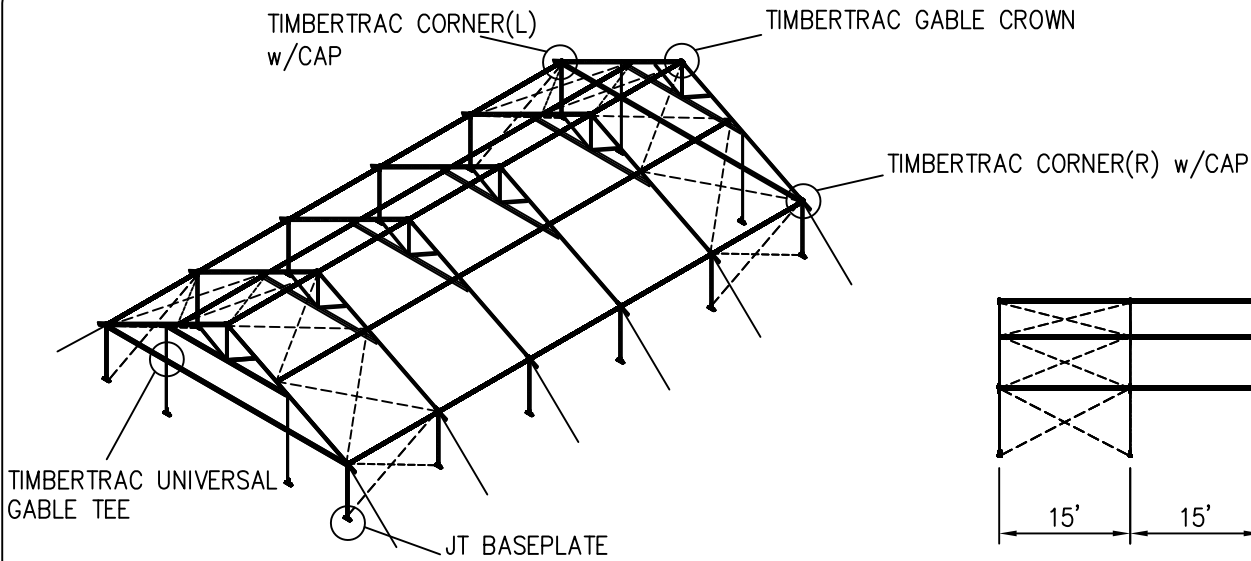

ISOMETRIC VIEW

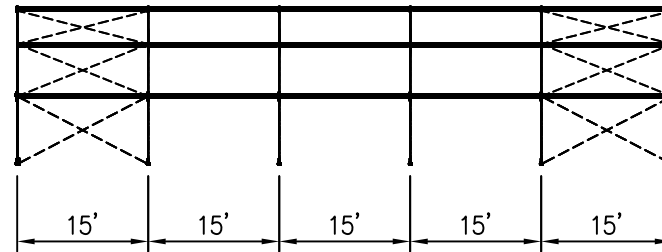

SIDE VIEW

40' X 75' TIMBERTRAC

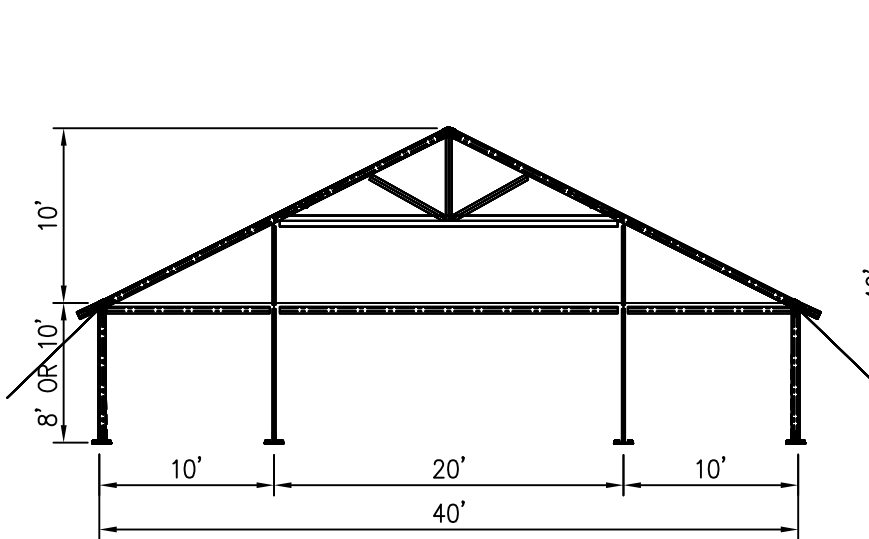

PLAN VIEW

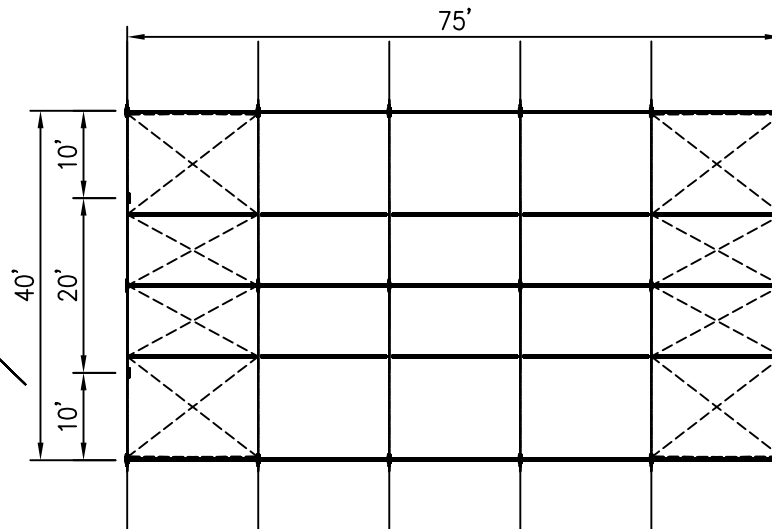

FRONT VIEW

ALL DATA AND INFORMATION CONTAINED IN OR DISCLOSED BY THIS DOCUMENT IS CONFIDENTIAL AND PROPRIETARY INFORMATION OF AZTEC TENTS AND ALL RIGHTS THEREIN ARE EXPRESSLY RESERVED. BY ACCEPTING THIS MATERIAL THE RECIPIENT AGREES THAT THIS MATERIAL AND INFORMATION CONTAINED THEREIN IS HELD IN CONFIDENCE AND IN TRUST AND WILL NOT BE COPIED, REPRODUCED WHOLE OR IN PART, NOR ITS CONTENTS REVEALED IN ANY MANNER TO OTHERS, EXCEPT TO MEET THE SPECIFIC PURPOSE FOR WHICH IT WAS DELIVERED.

AZTEC TENTS
 DESIGN & PRODUCTION
 2665 COLUMBIA ST. TORRANCE, CA. 90503
 (800) 228-3687 - FAX (310) 381-0722

TIMBERTRAC FRAME
 TIMBERTRAC FRAME TENT/STANDARD
 40' W X 75' L X 15' MIDDLE
 PART NUMBER: ZXXXXXXX

REVISION HISTORY			
BY:	DESCRIPTION:	BY:	DATE:

CONFIDENTIAL

ENGINEER:	N/A	DATE:	1/5/2017
DRAWN:	LYZ R.		

1 OF 1

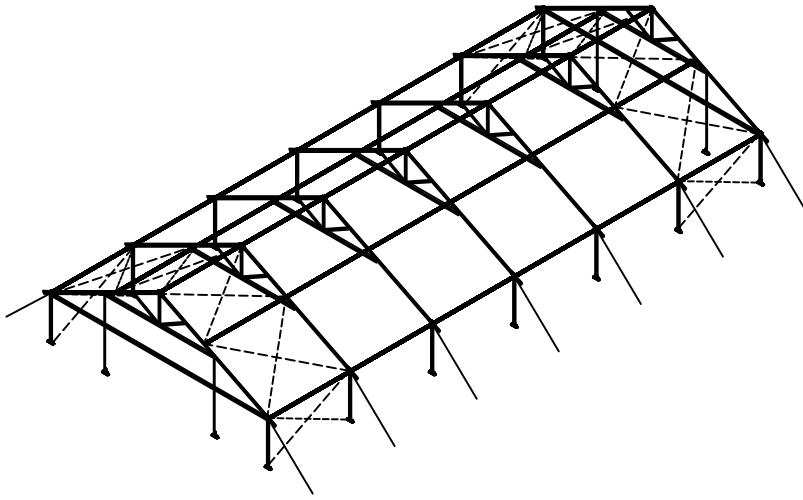

ISOMETRIC VIEW

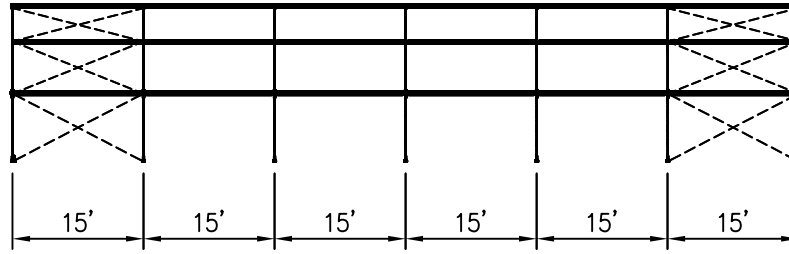

SIDE VIEW

40'X90' TIMBERTRAC FRAME

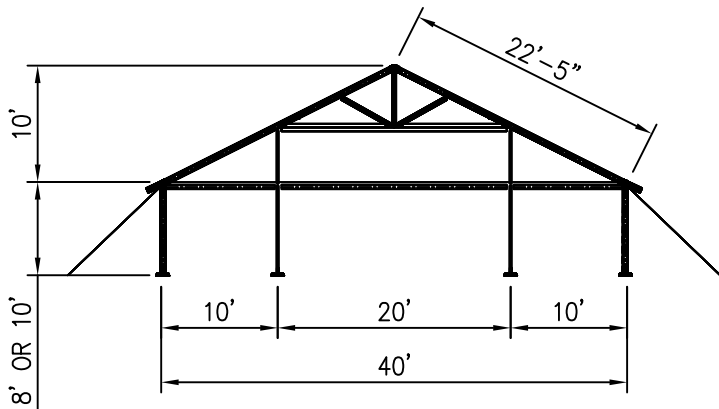

FRONT VIEW

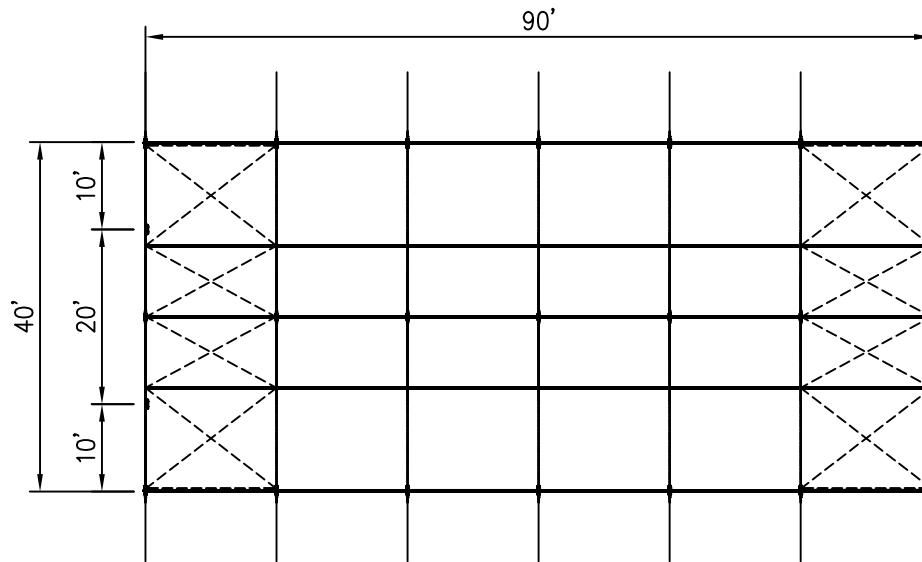

PLAN VIEW

ALL DATA AND INFORMATION CONTAINED IN OR DISCLOSED BY THIS DOCUMENT IS CONFIDENTIAL AND PROPRIETARY INFORMATION OF AZTEC TENTS AND ALL RIGHTS THEREIN ARE EXPRESSLY RESERVED. BY ACCEPTING THIS MATERIAL THE RECIPIENT AGREES THAT THIS MATERIAL AND INFORMATION CONTAINED THEREIN IS HELD IN CONFIDENCE AND IN TRUST AND WILL NOT BE COPIED, REPRODUCED WHOLE OR IN PART, NOR ITS CONTENTS REVEALED IN ANY MANNER TO OTHERS, EXCEPT TO MEET THE SPECIFIC PURPOSE FOR WHICH IT WAS DELIVERED.

AZTEC TENTS
 DESIGN & PRODUCTION
 2665 COLUMBIA ST. TORRANCE, CA. 90503
 (800) 228-3687 - FAX (310) 381-0722

TIMBERTRAC FRAME
 TIMBERTRAC FRAME TENT/STANDARD
 40' W X 90' L X 15' MIDDLE
 PART NUMBER: ZXXXXXXX

REVISION HISTORY			
DESCRIPTION	BY:	DATE:	

CONFIDENTIAL

ENGINEER:	N/A	DATE:	5/9/2016
DRAWN:			HUGO.R

1 OF 1