

ISOMETRIC VIEW

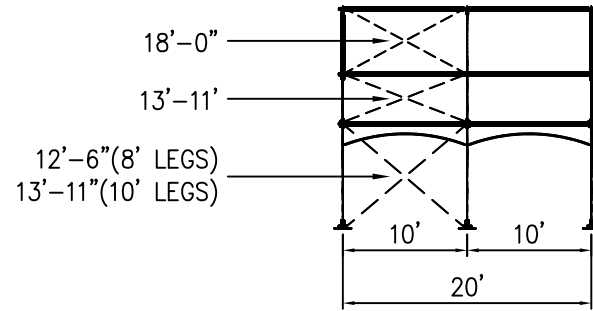

SIDE VIEW

50x20 TECTRAC SK STRUCTURE

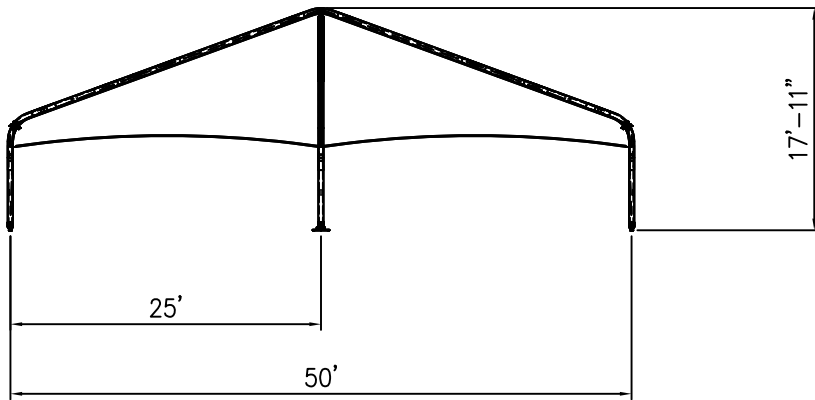

FRONT VIEW

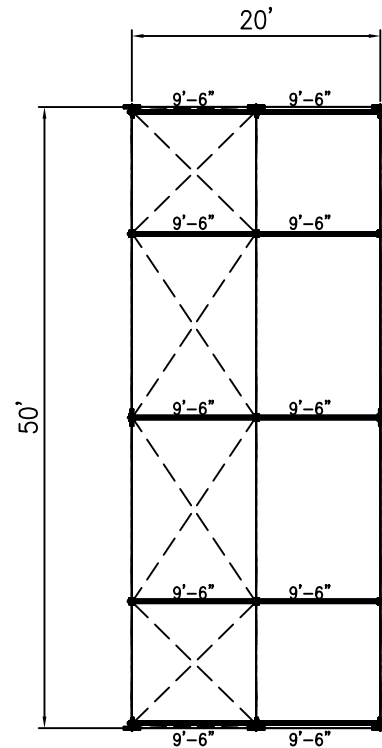

PLAN VIEW

ALL DATA AND INFORMATION CONTAINED IN OR DISCLOSED BY THIS DOCUMENT IS CONFIDENTIAL AND PROPRIETARY INFORMATION OF AZTEC TENTS AND ALL RIGHTS THEREIN ARE EXPRESSLY RESERVED. BY ACCEPTING THIS MATERIAL THE RECIPIENT AGREES THAT THIS MATERIAL AND INFORMATION CONTAINED THEREIN IS HELD IN CONFIDENCE AND IN TRUST AND WILL NOT BE COPIED, REPRODUCED WHOLE OR IN PART, NOR ITS CONTENTS REVEALED IN ANY MANNER TO OTHERS, EXCEPT TO MEET THE SPECIFIC PURPOSE FOR WHICH IT WAS DELIVERED.

AZTEC TENTS
 DESIGN & PRODUCTION
 2665 COLUMBIA ST. TORRANCE, CA. 90503
 (800) 228-3687 - FAX (310) 381-0722

TECTRAC SK STRUCTURE
 CENTER CLEAR STRUCTURE/STANDARD
 50'W X 20'L
 PART NUMBER: ZXXXXXXX

REVISION HISTORY			
REV.	DESCRIPTION	BY:	DATE:

CONFIDENTIAL

ENGINEER: N/A DATE: 9/27/2016
 PAGE: 1 OF 1 DRAWN: HUGO.R

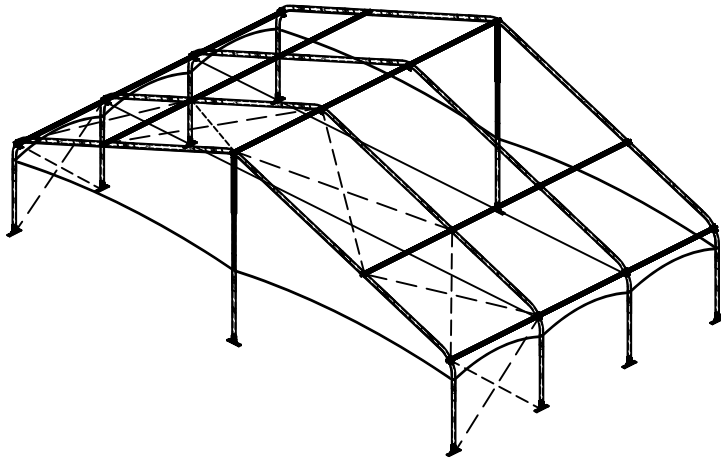

ISOMETRIC VIEW

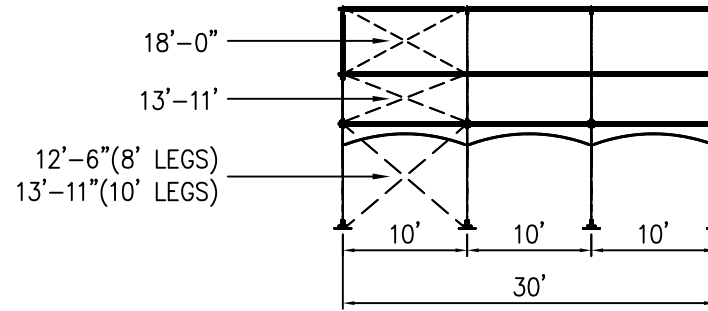

SIDE VIEW

50x30 TECTRAC SK STRUCTURE

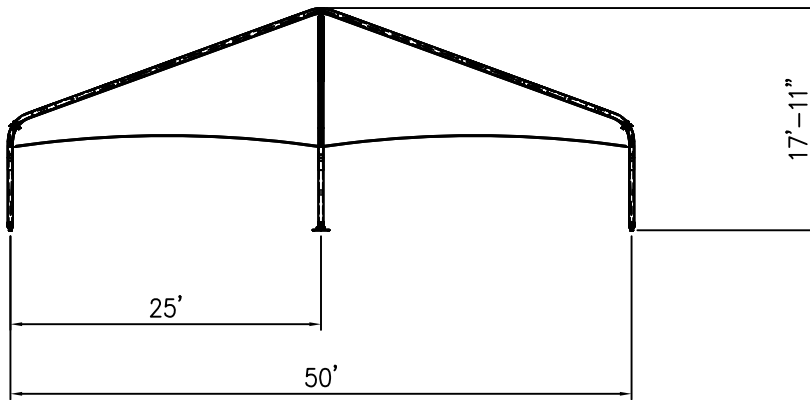

FRONT VIEW

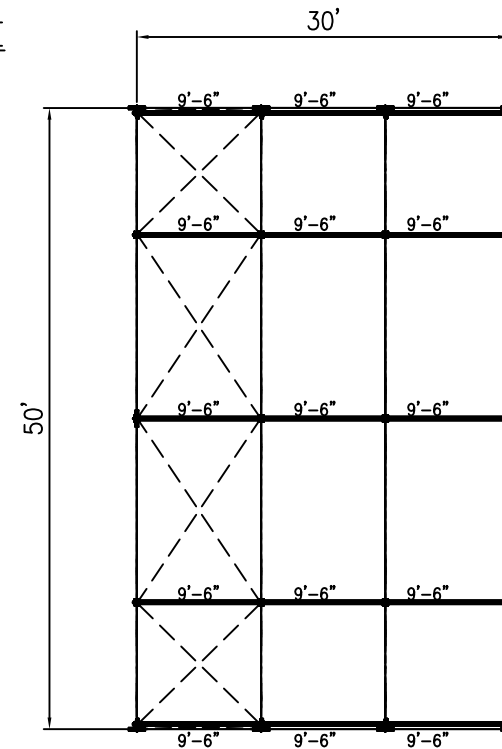

PLAN VIEW

ALL DATA AND INFORMATION CONTAINED IN OR DISCLOSED BY THIS DOCUMENT IS CONFIDENTIAL AND PROPRIETARY INFORMATION OF AZTEC TENTS AND ALL RIGHTS THEREIN ARE EXPRESSLY RESERVED. BY ACCEPTING THIS MATERIAL THE RECIPIENT AGREES THAT THIS MATERIAL AND INFORMATION CONTAINED THEREIN IS HELD IN CONFIDENCE AND IN TRUST AND WILL NOT BE COPIED, REPRODUCED WHOLE OR IN PART, NOR ITS CONTENTS REVEALED IN ANY MANNER TO OTHERS, EXCEPT TO MEET THE SPECIFIC PURPOSE FOR WHICH IT WAS DELIVERED.

AZTEC TENTS
 DESIGN & PRODUCTION
 2665 COLUMBIA ST. TORRANCE, CA. 90503
 (800) 228-3687 - FAX (310) 381-0722

TECTRAC SK STRUCTURE
 CENTER CLEAR STRUCTURE/STANDARD
 50'W X 20'L
 PART NUMBER: ZXXXXXXX

REVISION HISTORY			
REV.	DESCRIPTION	BY:	DATE:

CONFIDENTIAL

ENGINEER: N/A DATE: 9/27/2016
 PAGE: 1 OF 1 DRAWN: HUGO.R

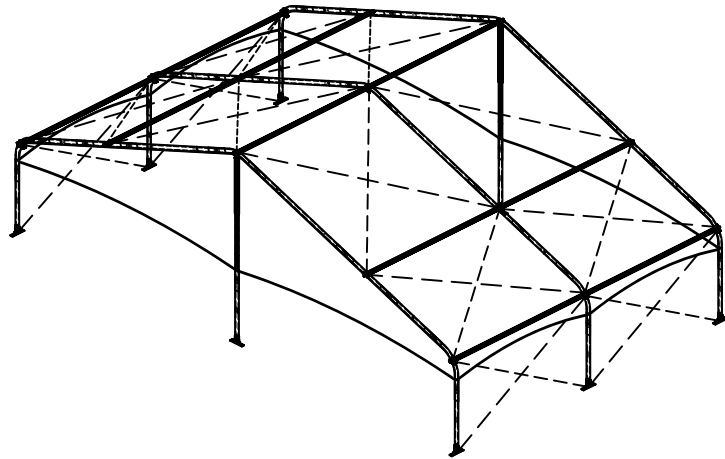

ISOMETRIC VIEW

50x30 TECTRAC SK STRUCTURE

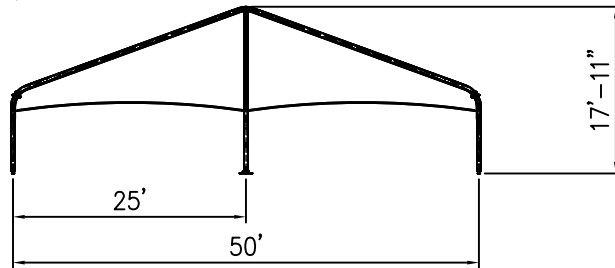

FRONT VIEW

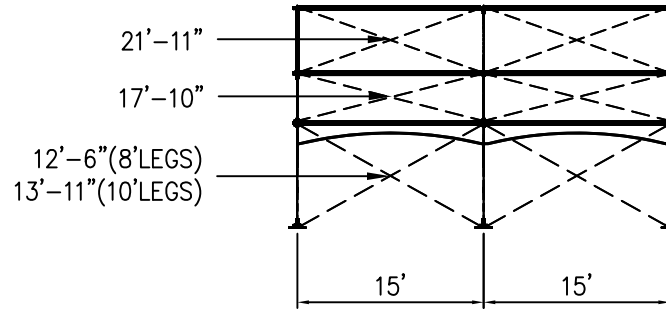

SIDE VIEW

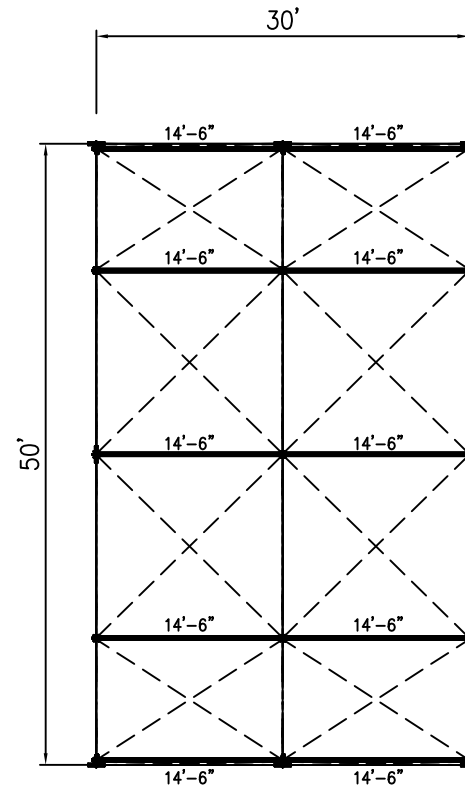

PLAN VIEW

ALL DATA AND INFORMATION CONTAINED IN OR DISCLOSED BY THIS DOCUMENT IS CONFIDENTIAL AND PROPRIETARY INFORMATION OF AZTEC TENTS AND ALL RIGHTS THEREIN ARE EXPRESSLY RESERVED. BY ACCEPTING THIS MATERIAL THE RECIPIENT AGREES THAT THIS MATERIAL AND INFORMATION CONTAINED THEREIN IS HELD IN CONFIDENCE AND IN TRUST AND WILL NOT BE COPIED, REPRODUCED WHOLE OR IN PART, NOR ITS CONTENTS REVEALED IN ANY MANNER TO OTHERS, EXCEPT TO MEET THE SPECIFIC PURPOSE FOR WHICH IT WAS DELIVERED.

AZTEC TENTS
 DESIGN & PRODUCTION
 2665 COLUMBIA ST. TORRANCE, CA. 90503
 (800) 228-3687 - FAX (310) 381-0722

TECTRAC SK STRUCTURE
 CENTER CLEAR STRUCTURE/STANDARD
 50'W X 30'L
 PART NUMBER: ZXXXXXXX

REVISION HISTORY			
REV.	DESCRIPTION	BY:	DATE:

CONFIDENTIAL

ENGINEER:	N/A	DATE:	9/27/2016
PAGE:	1 OF 1	DRAWN:	HUGO.R

ALL DATA AND INFORMATION CONTAINED IN OR DISCLOSED BY THIS DOCUMENT IS CONFIDENTIAL AND PROPRIETARY INFORMATION OF AZTEC TENTS AND ALL RIGHTS THEREIN ARE EXPRESSLY RESERVED. BY ACCEPTING THIS MATERIAL THE RECIPIENT AGREES THAT THIS MATERIAL AND INFORMATION CONTAINED THEREIN IS HELD IN CONFIDENCE AND IN TRUST AND WILL NOT BE COPIED, REPRODUCED WHOLE OR IN PART, NOR ITS CONTENTS REVEALED IN ANY MANNER TO OTHERS, EXCEPT TO MEET THE SPECIFIC PURPOSE FOR WHICH IT WAS DELIVERED.

AZTEC TENTS
 DESIGN & PRODUCTION
 2665 COLUMBIA ST. TORRANCE, CA, 90503
 (800) 228-3687 - FAX (310) 381-0722

TECTRAC SK STRUCTURE
 CENTER CLEAR STRUCTURE/STANDARD
 50'W X 40'L
 PART NUMBER: ZXXXXXXX

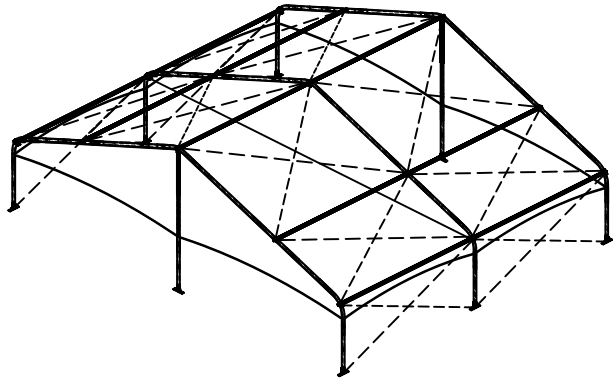

ISOMETRIC VIEW

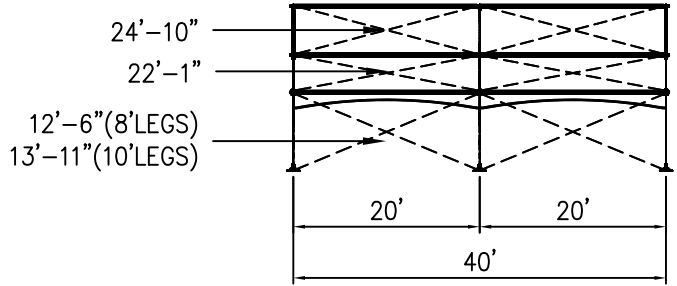

SIDE VIEW

50x40 TECTRAC SK STRUCTURE

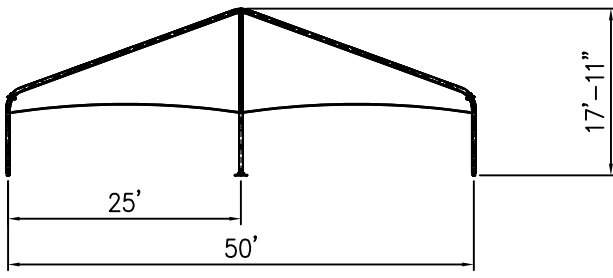

FRONT VIEW

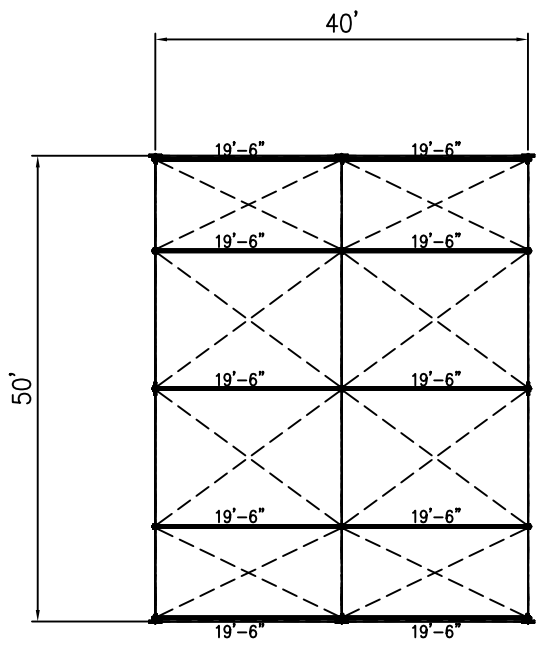

PLAN VIEW

REVISION HISTORY			
REV.	DESCRIPTION	BY:	DATE:

CONFIDENTIAL

ENGINEER:	N/A	DATE:	9/28/2016
PAGE:	1 OF 1	DRAWN:	HUGO.R

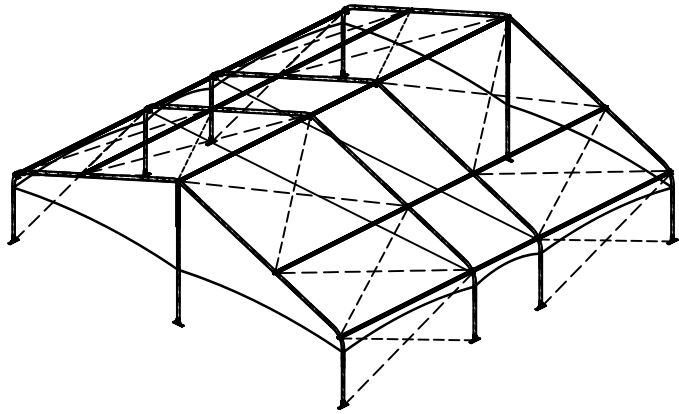

ISOMETRIC VIEW

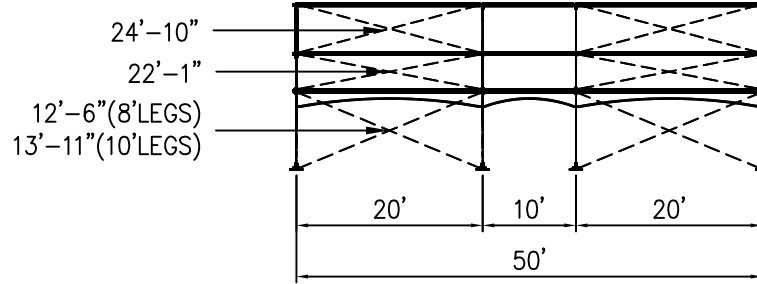

SIDE VIEW

50x50 TECTRAC SK STRUCTURE

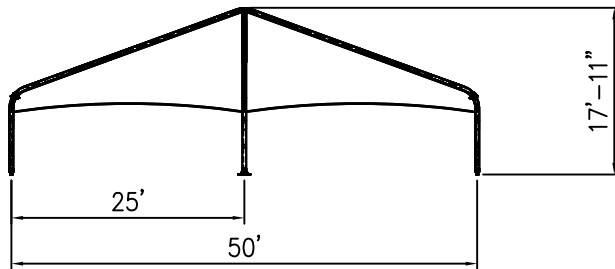

FRONT VIEW

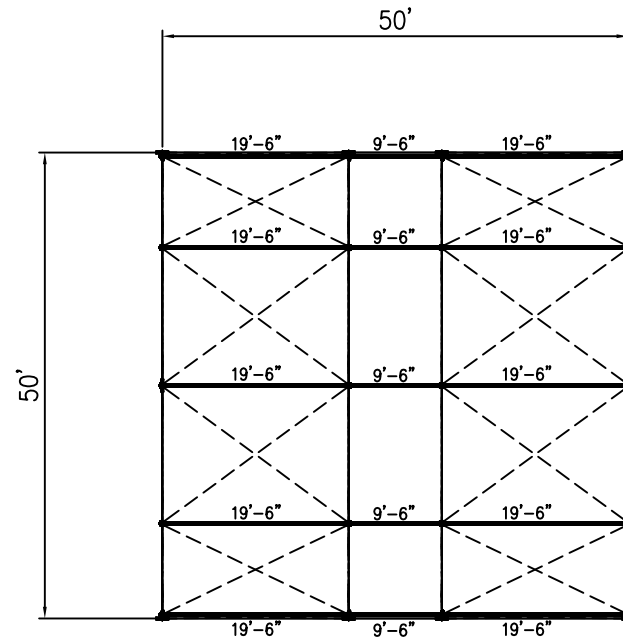

PLAN VIEW

ALL DATA AND INFORMATION CONTAINED IN OR DISCLOSED BY THIS DOCUMENT IS CONFIDENTIAL AND PROPRIETARY INFORMATION OF AZTEC TENTS AND ALL RIGHTS THEREIN ARE EXPRESSLY RESERVED. BY ACCEPTING THIS MATERIAL THE RECIPIENT AGREES THAT THIS MATERIAL AND INFORMATION CONTAINED THEREIN IS HELD IN CONFIDENCE AND IN TRUST AND WILL NOT BE COPIED, REPRODUCED WHOLE OR IN PART, NOR ITS CONTENTS REVEALED IN ANY MANNER TO OTHERS, EXCEPT TO MEET THE SPECIFIC PURPOSE FOR WHICH IT WAS DELIVERED.

AZTEC TENTS
 DESIGN & PRODUCTION
 2665 COLUMBIA ST. TORRANCE, CA. 90503
 (800) 228-3687 - FAX (310) 381-0722

TECTRAC SK STRUCTURE
 CENTER CLEAR STRUCTURE/STANDARD
 50'W X 50'L
 PART NUMBER: ZXXXXXXX

REVISION HISTORY			
REV.	DESCRIPTION	BY:	DATE:

CONFIDENTIAL

ENGINEER: N/A DATE: 9/28/2016
 PAGE: 1 OF 1 DRAWN: HUGO.R

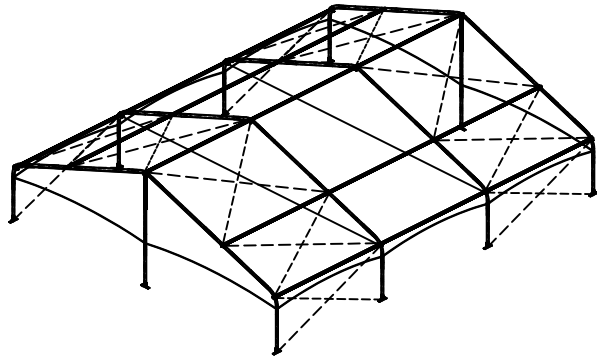

ISOMETRIC VIEW

24'-10"
 22'-1"
 12'-6" (8' LEGS)
 13'-11" (10' LEGS)

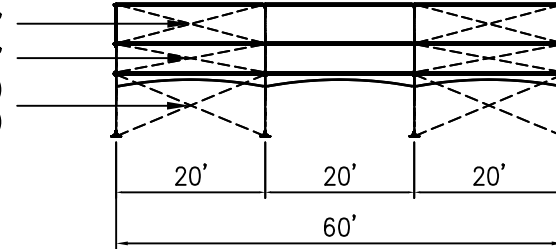

SIDE VIEW

50x60 TECTRAC SK STRUCTURE

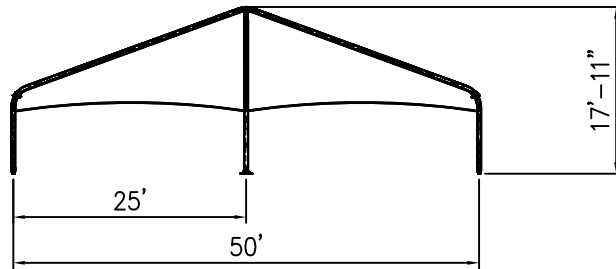

FRONT VIEW

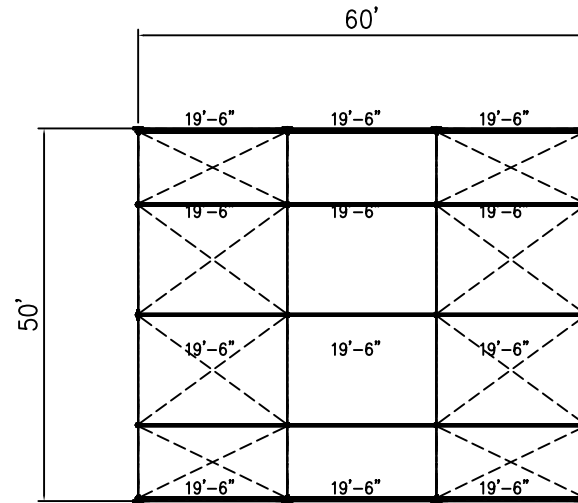

PLAN VIEW

ALL DATA AND INFORMATION CONTAINED IN OR DISCLOSED BY THIS DOCUMENT IS CONFIDENTIAL AND PROPRIETARY INFORMATION OF AZTEC TENTS AND ALL RIGHTS THEREIN ARE EXPRESSLY RESERVED. BY ACCEPTING THIS MATERIAL THE RECIPIENT AGREES THAT THIS MATERIAL AND INFORMATION CONTAINED THEREIN IS HELD IN CONFIDENCE AND IN TRUST AND WILL NOT BE COPIED, REPRODUCED WHOLE OR IN PART, NOR ITS CONTENTS REVEALED IN ANY MANNER TO OTHERS, EXCEPT TO MEET THE SPECIFIC PURPOSE FOR WHICH IT WAS DELIVERED.

AZTEC TENTS
 DESIGN & PRODUCTION
 2665 COLUMBIA ST. TORRANCE, CA. 90503
 (800) 228-3687 - FAX (310) 381-0722

TECTRAC SK STRUCTURE
 CENTER CLEAR STRUCTURE/STANDARD
 50'W X 60'L
 PART NUMBER: ZXXXXXXX

REVISION HISTORY			
REV.	DESCRIPTION	BY:	DATE:

CONFIDENTIAL

ENGINEER:	N/A	DATE:	9/28/2016
PAGE:	1 OF 1	DRAWN:	HUGO.R

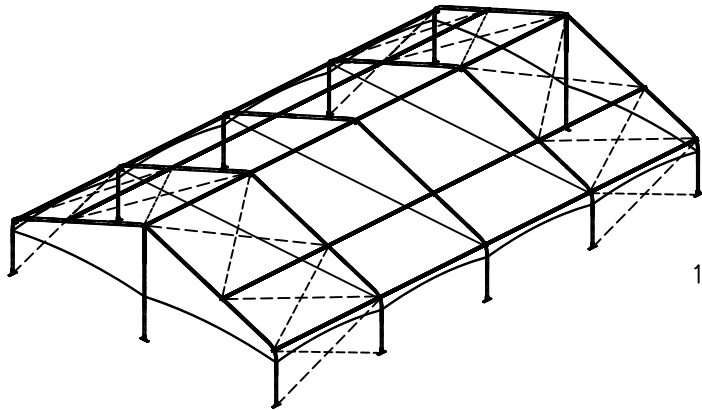

ISOMETRIC VIEW

24'-10"
 22'-1"
 12'-6" (8' LEGS)
 13'-11" (10' LEGS)

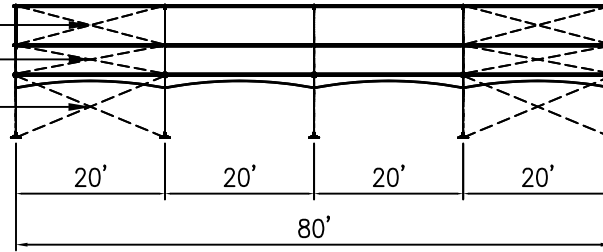

SIDE VIEW

50x80 TECTRAC SK STRUCTURE

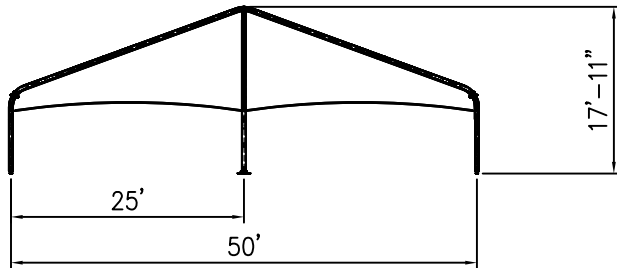

FRONT VIEW

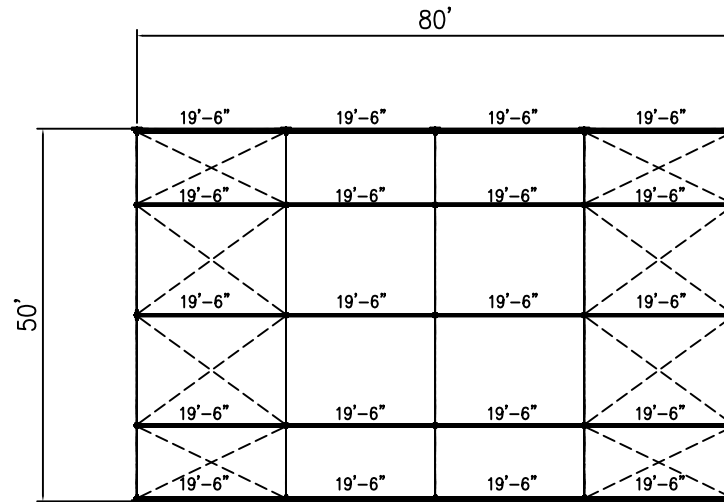

PLAN VIEW

ALL DATA AND INFORMATION CONTAINED IN OR DISCLOSED BY THIS DOCUMENT IS CONFIDENTIAL AND PROPRIETARY INFORMATION OF AZTEC TENTS AND ALL RIGHTS THEREIN ARE EXPRESSLY RESERVED. BY ACCEPTING THIS MATERIAL THE RECIPIENT AGREES THAT THIS MATERIAL AND INFORMATION CONTAINED THEREIN IS HELD IN CONFIDENCE AND IN TRUST AND WILL NOT BE COPIED, REPRODUCED WHOLE OR IN PART, NOR ITS CONTENTS REVEALED IN ANY MANNER TO OTHERS, EXCEPT TO MEET THE SPECIFIC PURPOSE FOR WHICH IT WAS DELIVERED.

AZTEC TENTS
 DESIGN & PRODUCTION
 2665 COLUMBIA ST. TORRANCE, CA, 90503
 (800) 228-3687 - FAX (310) 381-0722

TECTRAC SK STRUCTURE
 CENTER CLEAR STRUCTURE/STANDARD
 50'W X 80'L
 PART NUMBER: ZXXXXXXX

REVISION HISTORY			
REV.	DESCRIPTION	BY	DATE

CONFIDENTIAL

ENGINEER:	N/A	DATE:	9/28/2016
PAGE:	1 OF 1	DRAWN:	HUGO.R

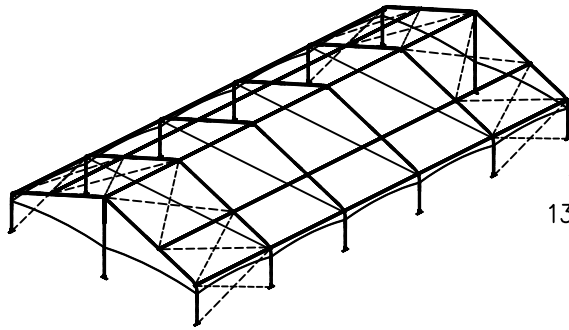

ISOMETRIC VIEW

24'-10"
 22'-1"
 12'-6" (8'LEGS)
 13'-11" (10'LEGS)

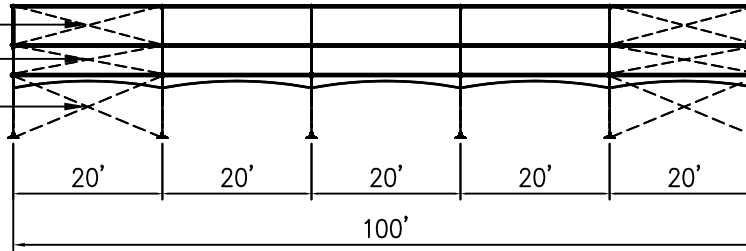

SIDE VIEW

50x100 TECTRAC SK STRUCTURE

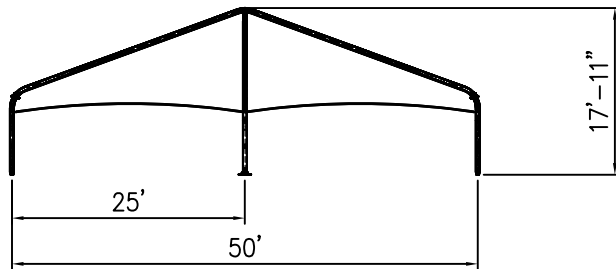

FRONT VIEW

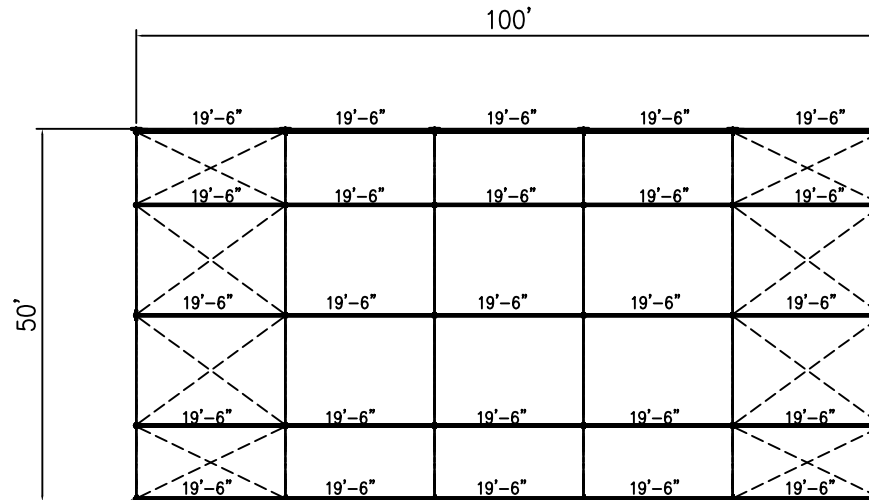

PLAN VIEW

ALL DATA AND INFORMATION CONTAINED IN OR DISCLOSED BY THIS DOCUMENT IS CONFIDENTIAL AND PROPRIETARY INFORMATION OF AZTEC TENTS AND ALL RIGHTS THEREIN ARE EXPRESSLY RESERVED. BY ACCEPTING THIS MATERIAL THE RECIPIENT AGREES THAT THIS MATERIAL AND INFORMATION CONTAINED THEREIN IS HELD IN CONFIDENCE AND IN TRUST AND WILL NOT BE COPIED, REPRODUCED WHOLE OR IN PART, NOR ITS CONTENTS REVEALED IN ANY MANNER TO OTHERS, EXCEPT TO MEET THE SPECIFIC PURPOSE FOR WHICH IT WAS DELIVERED.

AZTEC TENTS
 DESIGN & PRODUCTION
 2665 COLUMBIA ST. TORRANCE, CA, 90503
 (800) 228-3687 - FAX (310) 381-0722

TECTRAC SK STRUCTURE
 CENTER CLEAR STRUCTURE/STANDARD
 50'W X 100'L
 PART NUMBER: ZXXXXXXX

REVISION HISTORY			
REV.	DESCRIPTION	BY	DATE

CONFIDENTIAL

ENGINEER:	N/A	DATE:	9/28/2016
PAGE:	1 OF 1	DRAWN:	HUGO.R

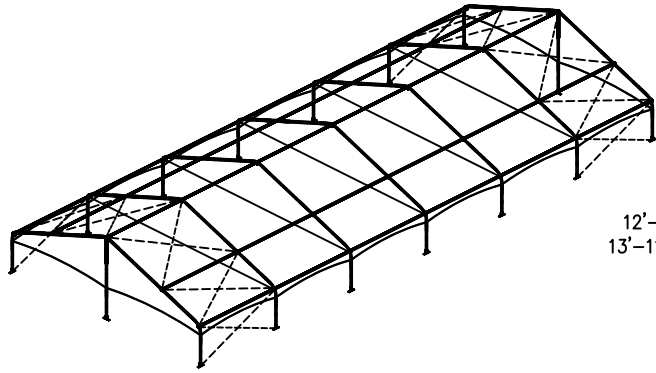

ISOMETRIC VIEW

24'-10"
22'-1"
12'-6" (8' LEGS)
13'-11" (10' LEGS)

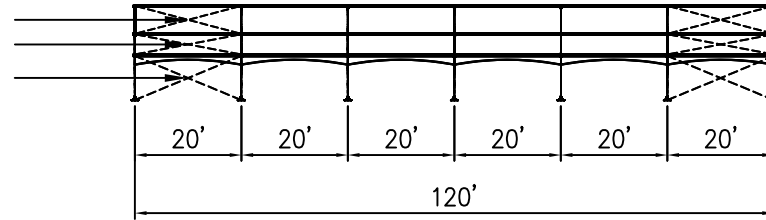

SIDE VIEW

50x120 TECTRAC SK STRUCTURE

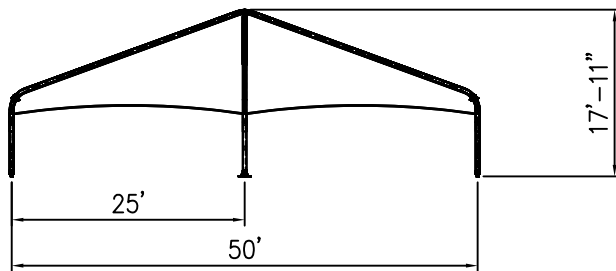

FRONT VIEW

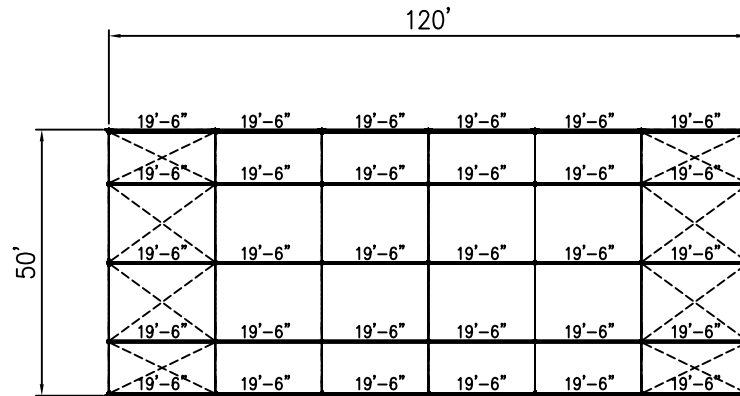

PLAN VIEW

ALL DATA AND INFORMATION CONTAINED IN OR DISCLOSED BY THIS DOCUMENT IS CONFIDENTIAL AND PROPRIETARY INFORMATION OF AZTEC TENTS AND ALL RIGHTS THEREIN ARE EXPRESSLY RESERVED. BY ACCEPTING THIS MATERIAL THE RECIPIENT AGREES THAT THIS MATERIAL AND INFORMATION CONTAINED THEREIN IS HELD IN CONFIDENCE AND IN TRUST AND WILL NOT BE COPIED, REPRODUCED WHOLE OR IN PART, NOR ITS CONTENTS REVEALED IN ANY MANNER TO OTHERS, EXCEPT TO MEET THE SPECIFIC PURPOSE FOR WHICH IT WAS DELIVERED.

AZTEC TENTS
DESIGN & PRODUCTION
2665 COLUMBIA ST. TORRANCE, CA, 90503
(800) 228-3687 - FAX (310) 381-0722

TECTRAC SK STRUCTURE
CENTER CLEAR STRUCTURE/STANDARD
50'W X 120'L
PART NUMBER: ZXXXXXXX

REVISION HISTORY			
REV.	DESCRIPTION	BY:	DATE:

CONFIDENTIAL

ENGINEER:	N/A	DATE:	9/28/2016
PAGE:	1 OF 1	DRAWN:	HUGO.R