

# Legend Series 50X Layout

L = LACELINE  
G = GROMMET

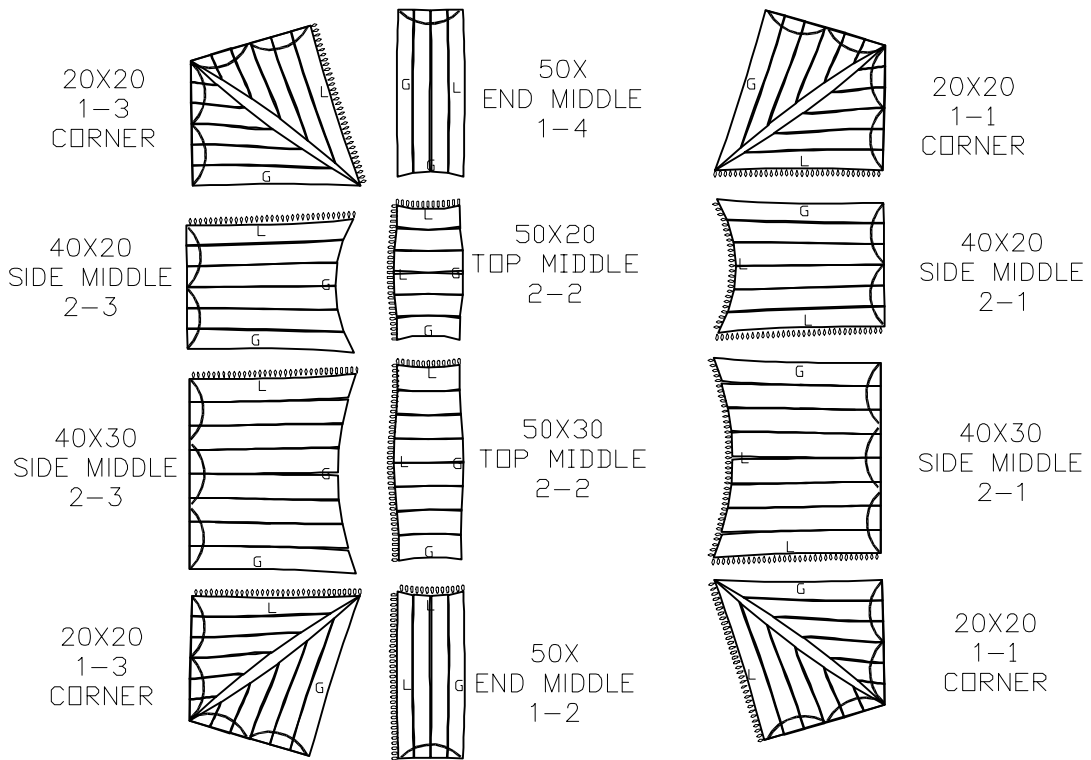

OUTSIDE

ALL DATA AND INFORMATION CONTAINED IN OR DISCLOSED BY THIS DOCUMENT IS CONFIDENTIAL AND PROPRIETARY INFORMATION OF AZTEC TENT AND EVENT INC. AND ALL RIGHTS THEREIN ARE EXPRESSLY RESERVED. BY ACCEPTING THIS MATERIAL THE RECIPIENT AGREES THAT THIS MATERIAL AND INFORMATION CONTAINED THEREIN IS HELD IN CONFIDENCE AND IN TRUST AND WILL NOT BE COPIED, REPRODUCED WHOLE OR IN PART, NOR ITS CONTENTS REVEALED IN ANY MANNER TO OTHERS, EXCEPT TO MEET THE SPECIFIC PURPOSE FOR WHICH IT WAS DELIVERED.



540 HAWAII AVE. TORRANCE, CA. 90503  
(800) 258-7368 - (310) 328-5060 - FAX (310) 328-5356

## STANDARD PATTERN LOCATIONS

40-50-60 LEGEND POLE / STANDARD

ENGINEER CM DRAWN AK  
CHECKED - DATE 11-04-05

PART DESCRIPTION	CODE	SIZE	DRAWING NUMBER	REV
----	AZ	40-50-60-	PATTERNS	0

40-50-60\PATTERNS 020609 0950

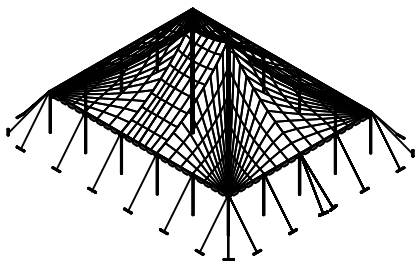

ISOMETRIC VIEW

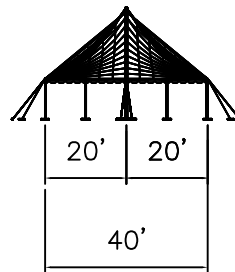

SIDE VIEW

LEGEND 40-50-60  
50' x 40'

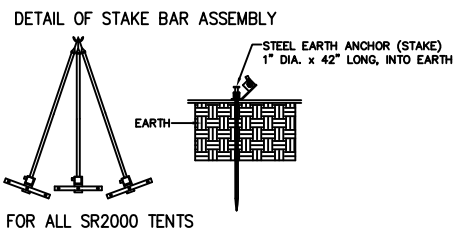

FOR ALL SR2000 TENTS

● = CENTER POLES NOT TO SCALE

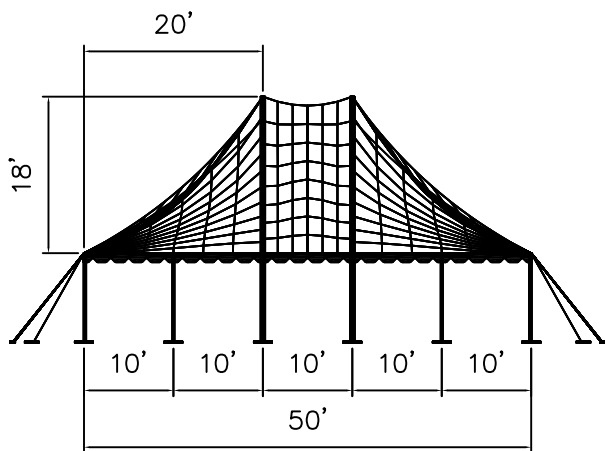

END VIEW

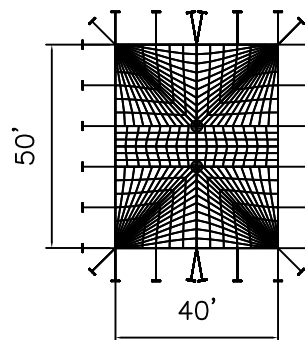

PLAN VIEW

ALL DATA AND INFORMATION CONTAINED IN OR DISCLOSED BY THIS DOCUMENT IS CONFIDENTIAL AND PROPRIETARY INFORMATION OF AZTEC TENTS AND ALL RIGHTS THEREIN ARE EXPRESSLY RESERVED. BY ACCEPTING THIS MATERIAL THE RECIPIENT AGREES THAT THIS MATERIAL AND INFORMATION CONTAINED THEREIN IS HELD IN CONFIDENCE AND IN TRUST AND WILL NOT BE COPIED, REPRODUCED, WHOLE OR IN PART, NOR ITS CONTENTS REVEALED, IN ANY MANNER TO ANY OTHERS, WITHOUT MEET THE SPECIFIC PURPOSE FOR WHICH IT WAS DELIVERED.

**AZTEC TENTS**  
DESIGN & PRODUCTION  
2665 COLUMBIA ST. TORRANCE, CA. 90503  
(800) 228-3687 - FAX (310) 381-0722

LEGEND SERIES FRAME  
LEGEND POLE/STANDARD  
50'W X 40'L LEGEND POLE  
PART NUMBER: ZXXXXXX

REVISION HISTORY			
REV.	DESCRIPTION:	BY:	DATE:

**CONFIDENTIAL**

ENGINEER: N/A	DATE: 5/26/2016
PAGE: 1 OF 1	DRAWN: HUGO.R

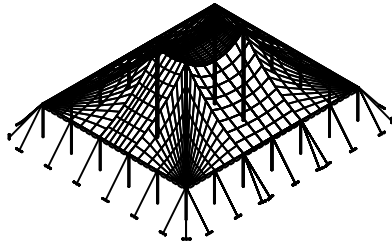

ISOMETRIC VIEW

LEGEND 40-50-60  
50' x 60'

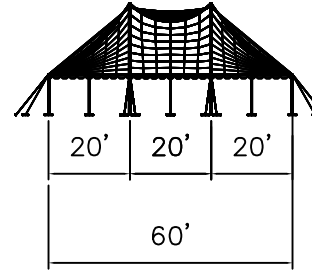

SIDE VIEW

DETAIL OF STAKE BAR ASSEMBLY

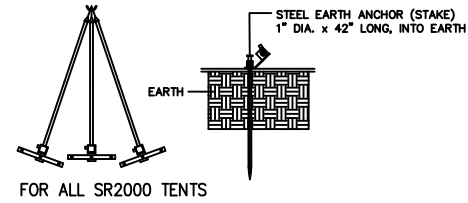

FOR ALL SR2000 TENTS

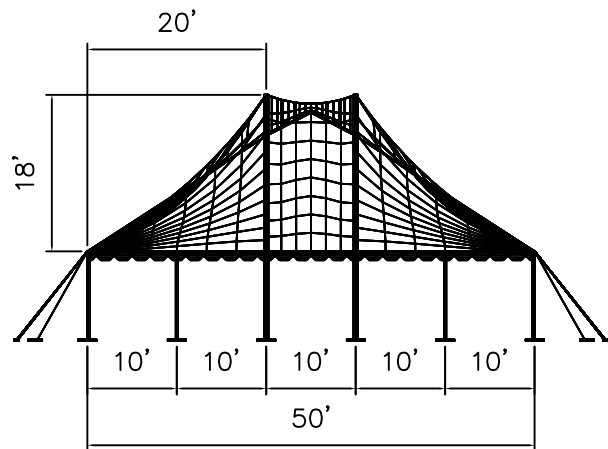

END VIEW

● = CENTER POLES NOT TO SCALE

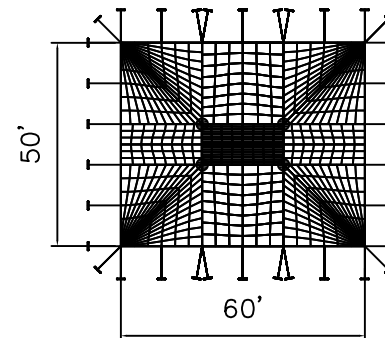

PLAN VIEW

ALL DATA AND INFORMATION CONTAINED IN OR DISCLOSED BY THIS DOCUMENT IS CONFIDENTIAL AND PROPRIETARY INFORMATION OF AZTEC TENTS AND ALL RIGHTS THEREIN ARE EXPRESSLY RESERVED. BY ACCEPTING THIS MATERIAL THE RECIPIENT AGREES THAT THIS MATERIAL AND INFORMATION CONTAINED THEREIN IS HELD IN CONFIDENCE AND IN TRUST AND WILL NOT BE COPIED, REPRODUCED, WHOLE OR IN PART, NOR ITS CONTENTS REVEALED, IN ANY MANNER TO ANY OTHERS, WITHOUT MEETING THE SPECIFIC PURPOSE FOR WHICH IT WAS DELIVERED.

**AZTEC TENTS**  
DESIGN & PRODUCTION  
2665 COLUMBIA ST. TORRANCE, CA 90503  
(800) 228-3687 - FAX (310) 381-0722

LEGEND SERIES FRAME  
LEGEND PO/E/STANDARD  
50'W X 60'L LEGEND POLE TENT  
PART NUMBER: ZXXXXXX

REVISION HISTORY			
REV.	DESCRIPTION:	BY:	DATE:

**CONFIDENTIAL**

ENGINEER: N/A	DATE: 5/26/2016
PAGE: 1 OF 1	DRAWN: HUGO.R

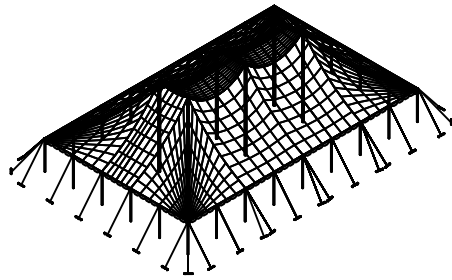

ISOMETRIC VIEW

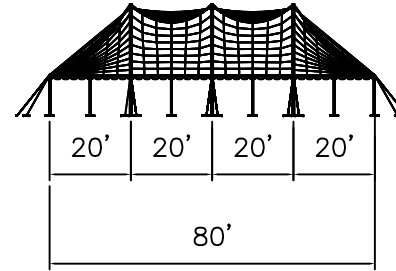

SIDE VIEW

LEGEND 40-50-60  
50' x 80'

DETAIL OF STAKE BAR ASSEMBLY

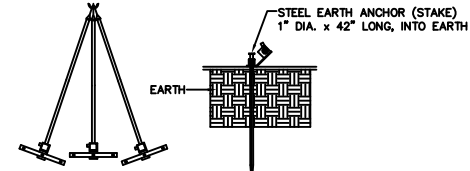

FOR ALL SR2000 TENTS

● = CENTER POLES NOT TO SCALE

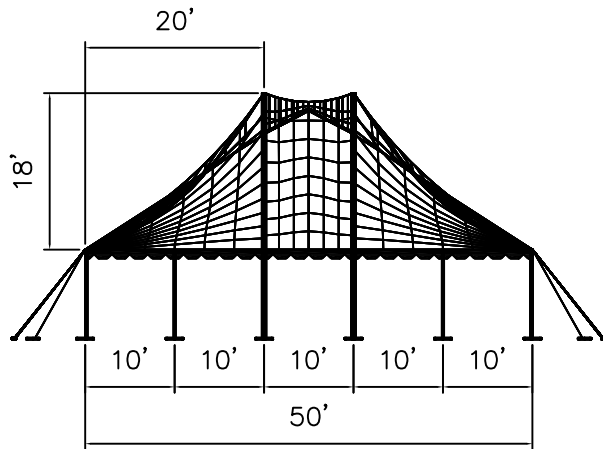

END VIEW

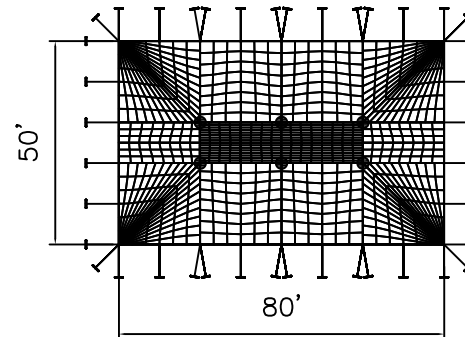

PLAN VIEW

ALL DATA AND INFORMATION CONTAINED IN OR DISCLOSED BY THIS DOCUMENT IS CONFIDENTIAL AND PROPRIETARY INFORMATION OF AZTEC TENTS AND ALL RIGHTS THEREIN ARE EXPRESSLY RESERVED. BY ACCEPTING THIS MATERIAL THE RECIPIENT AGREES THAT THIS MATERIAL AND INFORMATION CONTAINED THEREIN IS HELD IN CONFIDENCE AND IN TRUST AND WILL NOT BE COPIED, REPRODUCED WHOLE OR IN PART, NOR ITS CONTENTS REVEALED, IN ANY MANNER TO ANY OTHERS, WITHOUT MEET THE SPECIFIC PURPOSE FOR WHICH IT WAS DELIVERED.

**AZTEC TENTS**  
DESIGN & PRODUCTION  
2665 COLUMBIA ST. TORRANCE, CA. 90503  
(800) 228-3687 - FAX (310) 381-0722

LEGEND SERIES FRAME  
LEGEND POLE/STANDARD  
50'W X 80'L LEGEND POLE TENT  
PART NUMBER: ZXXXXXX

REVISION HISTORY			
REV.	DESCRIPTION:	BY:	DATE:

**CONFIDENTIAL**

ENGINEER: N/A	DATE: 5/26/2016
PAGE: 1 OF 1	DRAWN: HUGO.R

# 50' x 70' Expandable Pole Tent

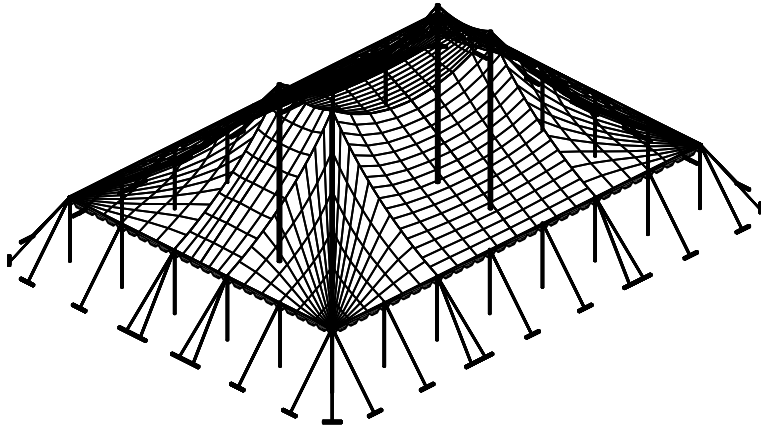

ISOMETRIC ELEVATION

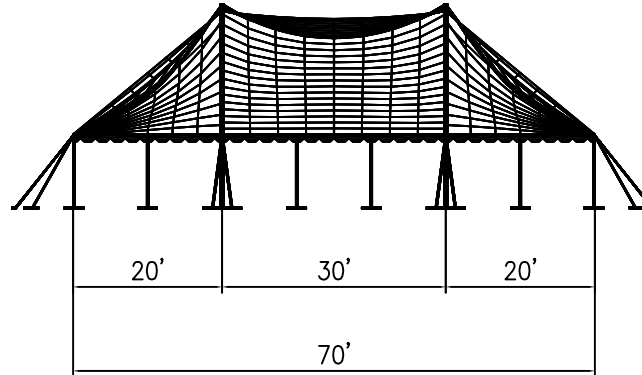

SIDE ELEVATION

## 50x70 LEGEND POLE

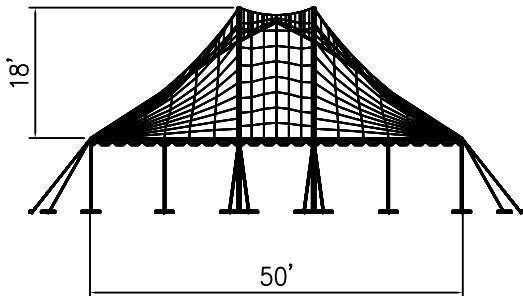

FRONT ELEVATION

● = CENTER POLES NOT TO SCALE

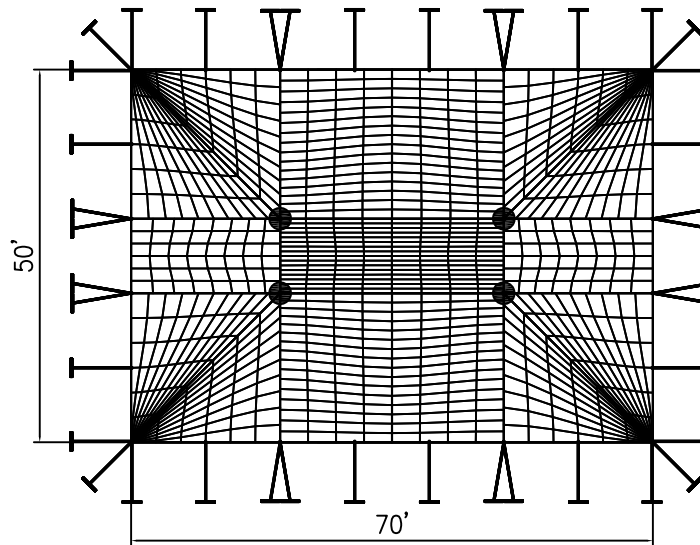

PLAN ELEVATION

ALL DATA AND INFORMATION CONTAINED IN OR DISCLOSED BY THIS DOCUMENT IS CONFIDENTIAL AND PROPRIETARY INFORMATION OF AZTEC TENTS AND ALL RIGHTS THEREIN ARE EXPRESSLY RESERVED. BY ACCEPTING THIS MATERIAL THE RECIPIENT AGREES THAT THIS MATERIAL AND INFORMATION CONTAINED THEREIN IS HELD IN CONFIDENCE AND IN TRUST AND WILL NOT BE COPIED, REPRODUCED WHOLE OR IN PART, NOR ITS CONTENTS REVEALED IN ANY MANNER TO OTHERS, EXCEPT TO MEET THE SPECIFIC PURPOSE FOR WHICH IT WAS DELIVERED.

**AZTEC TENTS**  
 DESIGN & PRODUCTION  
 2665 COLUMBIA ST. TORRANCE, CA. 90503  
 (800) 228-3687 - FAX (310) 381-0722

**LEGEND SERIES FRAME**  
 LEGEND PO;E/STANDARD  
 50'W X 70'L X 10' LEGS  
 PART NUMBER: ZXXXXXXX

REVISION HISTORY			
REV.	DESCRIPTION	BY:	DATE:

**CONFIDENTIAL**

ENGINEER: N/A	DATE: 5/26/2016
PAGE: 1 OF 1	DRAWN: HUGO.R