

ALL DATA AND INFORMATION CONTAINED IN OR DISCLOSED BY THIS DOCUMENT IS CONFIDENTIAL AND PROPRIETARY INFORMATION OF AZTEC TENTS AND ALL RIGHTS THEREIN ARE EXPRESSLY RESERVED. BY ACCEPTING THIS MATERIAL THE RECIPIENT AGREES THAT THIS MATERIAL AND INFORMATION CONTAINED THEREIN IS HELD IN CONFIDENCE AND IN TRUST AND WILL NOT BE COPIED, REPRODUCED WHOLE OR IN PART, NOR ITS CONTENTS REVEALED IN ANY MANNER TO OTHERS, EXCEPT TO MEET THE SPECIFIC PURPOSE FOR WHICH IT WAS DELIVERED.

AZTEC TENTS
 DESIGN & PRODUCTION
 2665 COLUMBIA ST. TORRANCE, CA. 90503
 (800) 228-3687 - FAX (310) 381-0722

JUMBOTRAC FRAME
 JUMBOTRAC / STANDARD
 50' W X 50'
 PART NUMBER: ZXXXXXXX

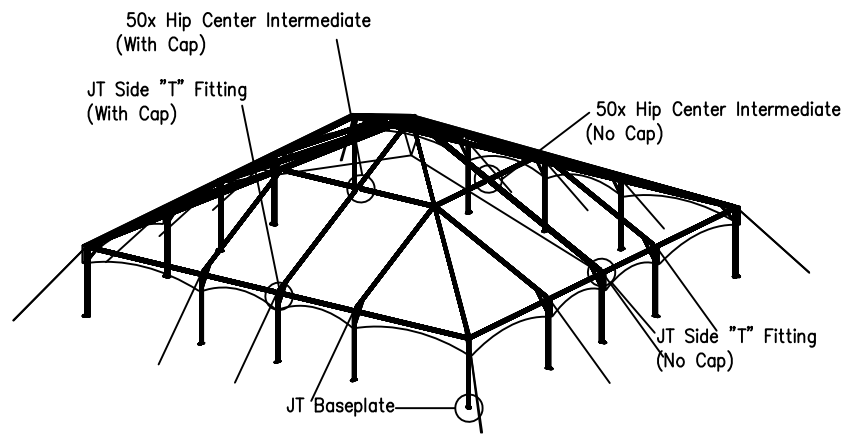

ISOMETRIC VIEW

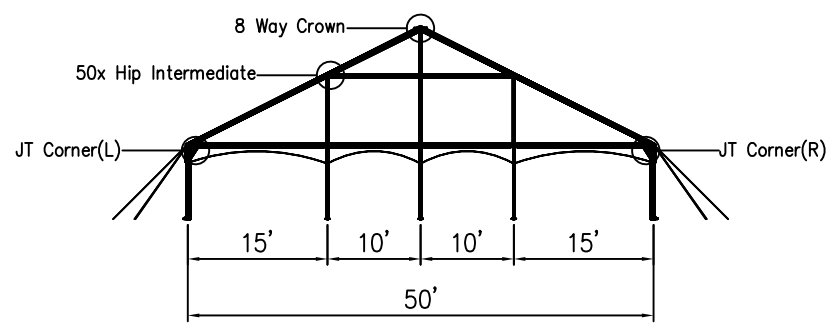

SIDE VIEW

50' x 50' JUMBOTRAC FRAME TENT

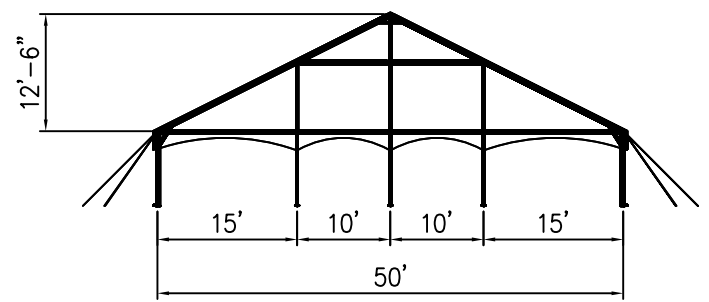

VIEW A-A

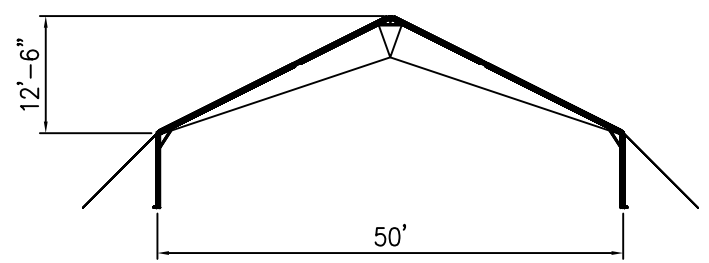

VIEW B-B

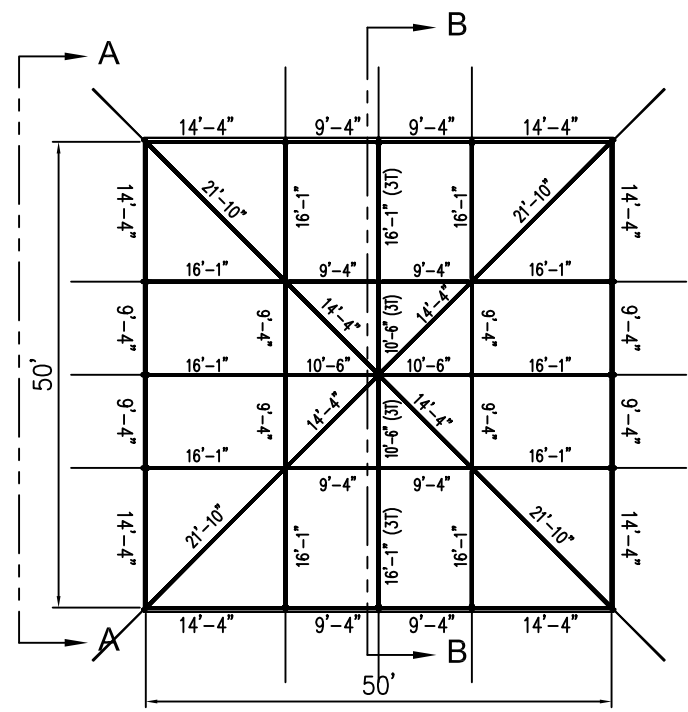

PLAN VIEW

REVISION HISTORY			
REV.	DESCRIPTION	BY:	DATE:
N/A	N/A	N/A	N/A
N/A	N/A	N/A	N/A
N/A	N/A	N/A	N/A
N/A	N/A	N/A	N/A
N/A	N/A	N/A	N/A

CONFIDENTIAL

ENGINEER:	N/A	DATE:	8/11/2016
PAGE:	1 OF 1	DRAWN:	HUGO.R

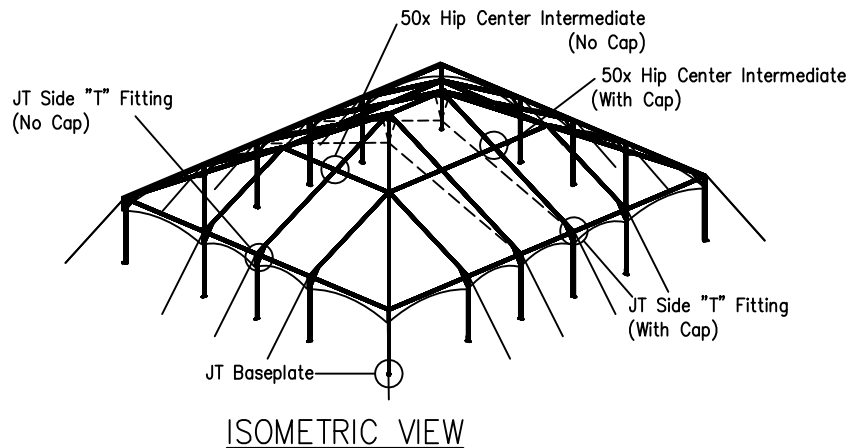

ISOMETRIC VIEW

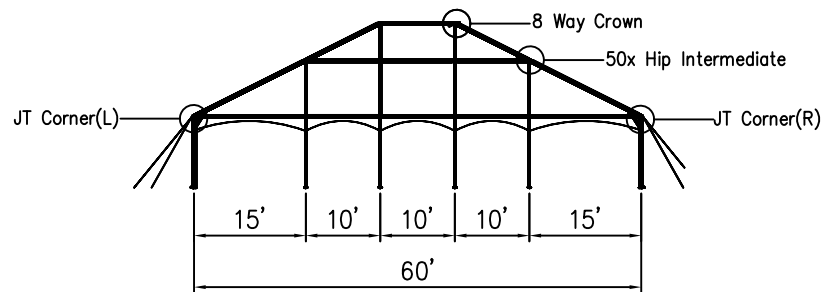

SIDE VIEW

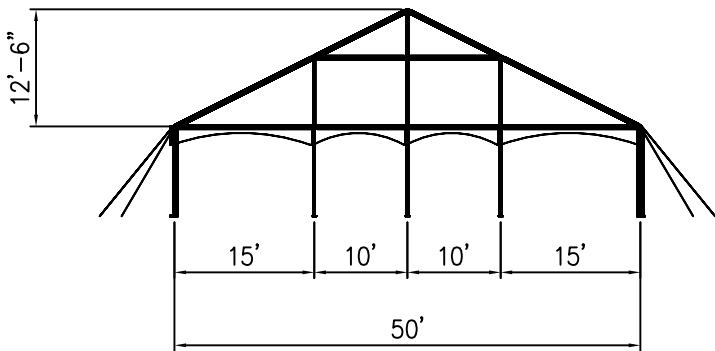

VIEW A-A

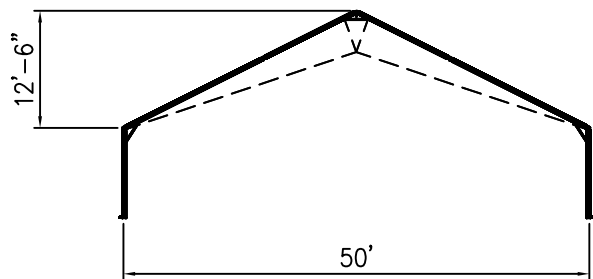

VIEW B-B

50' x 60' JUMBOTRAC FRAME TENT

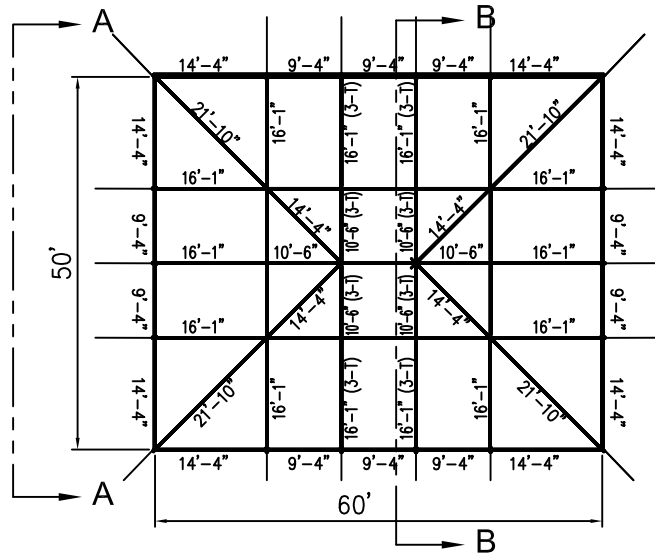

PLAN VIEW

ALL DATA AND INFORMATION CONTAINED IN OR DISCLOSED BY THIS DOCUMENT IS CONFIDENTIAL AND PROPRIETARY INFORMATION OF AZTEC TENTS AND ALL RIGHTS THEREIN ARE EXPRESSLY RESERVED. BY ACCEPTING THIS MATERIAL THE RECIPIENT AGREES THAT THIS MATERIAL AND INFORMATION CONTAINED THEREIN IS HELD IN CONFIDENCE AND IN TRUST AND WILL NOT BE COPIED, REPRODUCED WHOLE OR IN PART, NOR ITS CONTENTS REVEALED IN ANY MANNER TO OTHERS, EXCEPT TO MEET THE SPECIFIC PURPOSE FOR WHICH IT WAS DELIVERED.

AZTEC TENTS
 DESIGN & PRODUCTION
 2665 COLUMBIA ST. TORRANCE, CA. 90503
 (800) 228-3687 - FAX (310) 381-0722

JUMBOTRAC FRAME
 JUMBOTRAC / STANDARD
 50'W X 60'L
 PART NUMBER: ZXXXXXX

REVISION HISTORY			
REV.	DESCRIPTION	BY:	DATE:
N/A	N/A	N/A	N/A
N/A	N/A	N/A	N/A
N/A	N/A	N/A	N/A
N/A	N/A	N/A	N/A
N/A	N/A	N/A	N/A

CONFIDENTIAL

ENGINEER:	N/A	DATE:	7/21/2016
PAGE:	1 OF 1	DRAWN:	HUGO.R

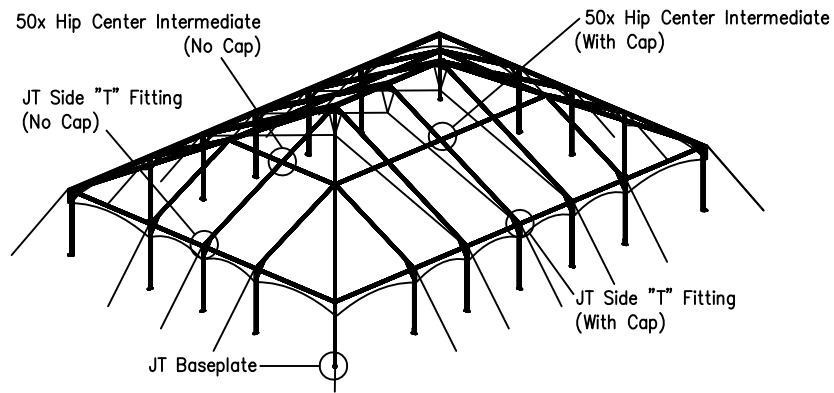

ISOMETRIC VIEW

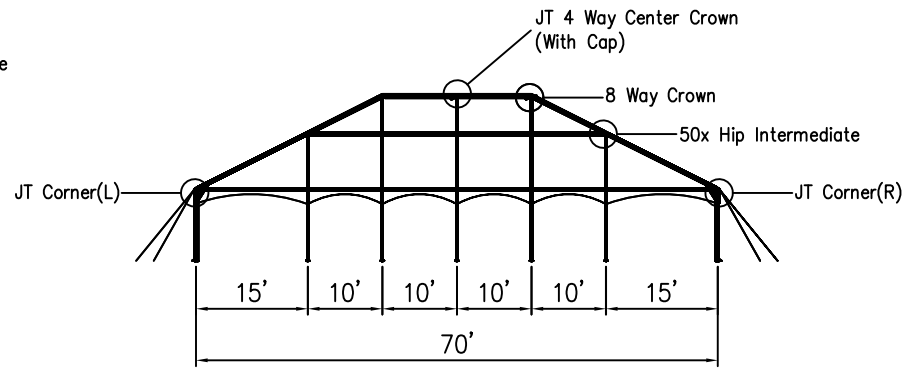

SIDE VIEW

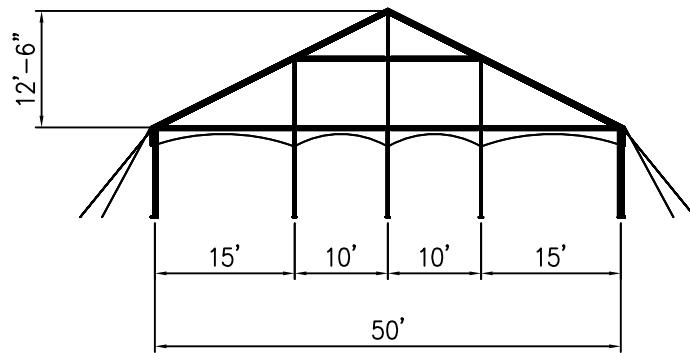

VIEW A-A

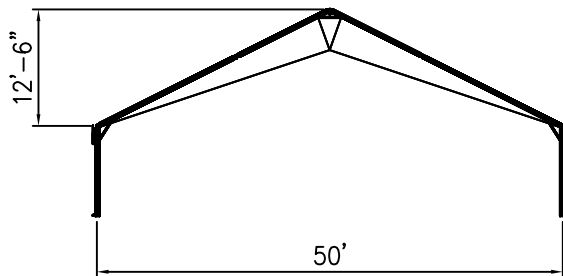

VIEW B-B

50' x 70' JUMBOTRAC FRAME TENT

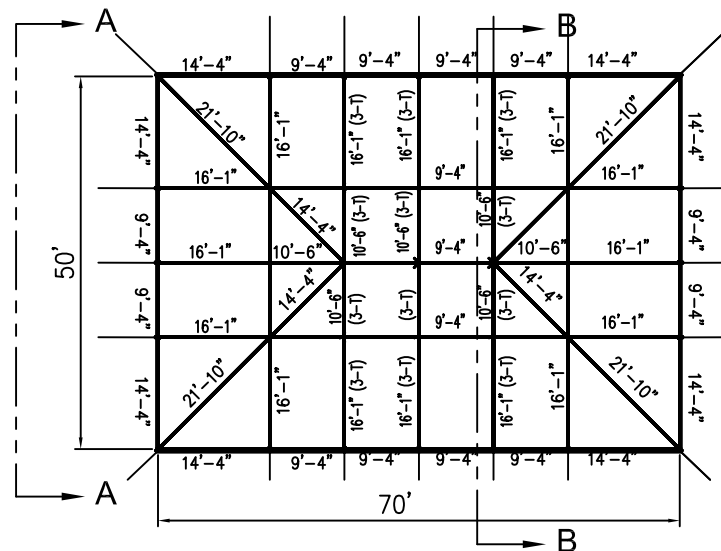

PLAN VIEW

ALL DATA AND INFORMATION CONTAINED IN OR DISCLOSED BY THIS DOCUMENT IS CONFIDENTIAL AND PROPRIETARY INFORMATION OF AZTEC TENTS AND ALL RIGHTS THEREIN ARE EXPRESSLY RESERVED. BY ACCEPTING THIS MATERIAL THE RECIPIENT AGREES THAT THIS MATERIAL AND INFORMATION CONTAINED THEREIN IS HELD IN CONFIDENCE AND IN TRUST AND WILL NOT BE COPIED, REPRODUCED WHOLE OR IN PART, NOR ITS CONTENTS REVEALED IN ANY MANNER TO OTHERS, EXCEPT TO MEET THE SPECIFIC PURPOSE FOR WHICH IT WAS DELIVERED.

AZTEC TENTS
 DESIGN & PRODUCTION
 2665 COLUMBIA ST. TORRANCE, CA. 90503
 (800) 228-3687 - FAX (310) 381-0722

JUMBOTRAC FRAME
 JUMBOTRAC / STANDARD
 50'W X 70'L
 PART NUMBER: ZXXXXXXX

REVISION HISTORY			
REV.	DESCRIPTION	BY:	DATE:
N/A	N/A	N/A	N/A
N/A	N/A	N/A	N/A
N/A	N/A	N/A	N/A
N/A	N/A	N/A	N/A
N/A	N/A	N/A	N/A

CONFIDENTIAL

ENGINEER: N/A DATE: 8/11/2016
 PAGE: 1 OF 1 DRAWN: HUGO.R

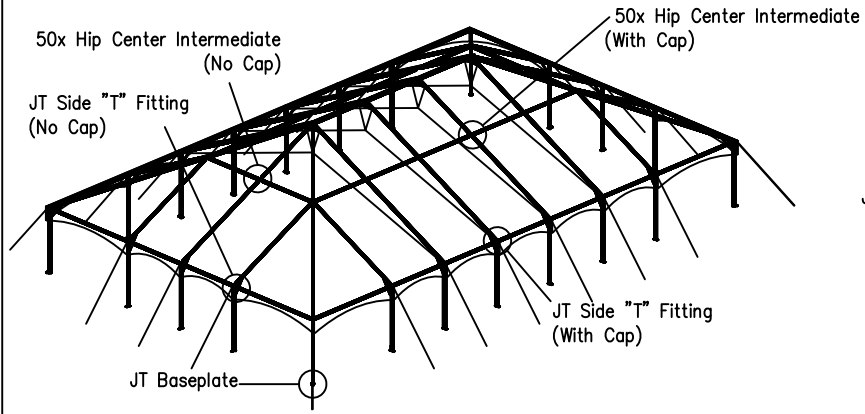

ISOMETRIC VIEW

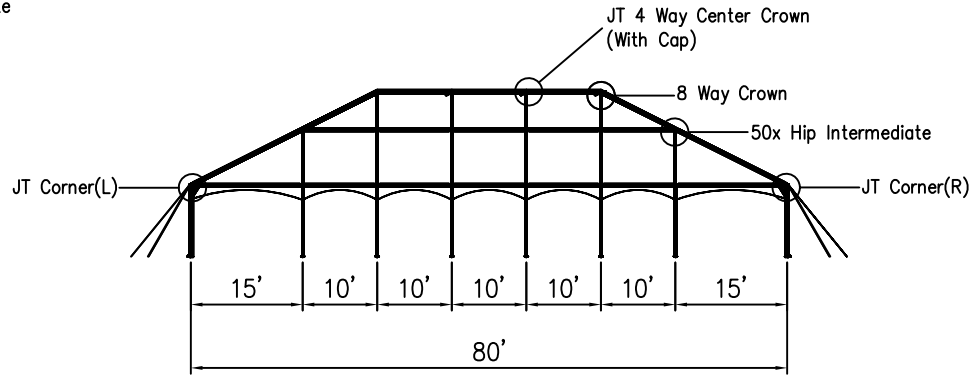

SIDE VIEW

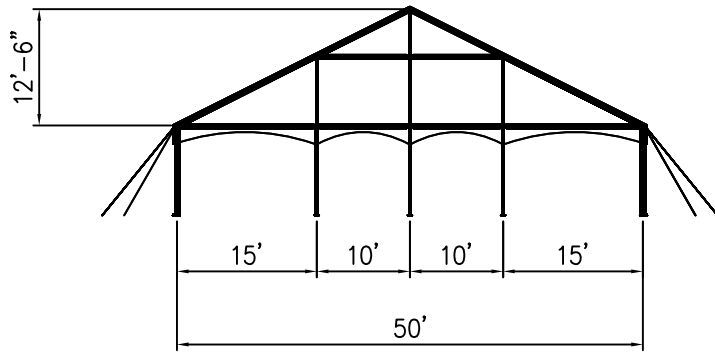

VIEW A-A

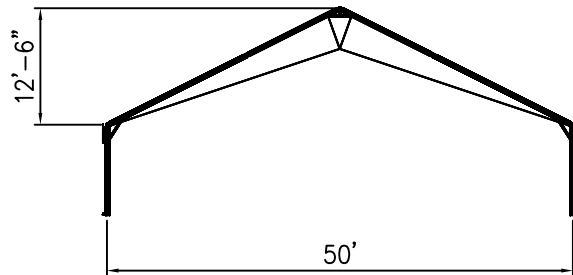

VIEW B-B

50' x 80' JUMBOTRAC FRAME TENT

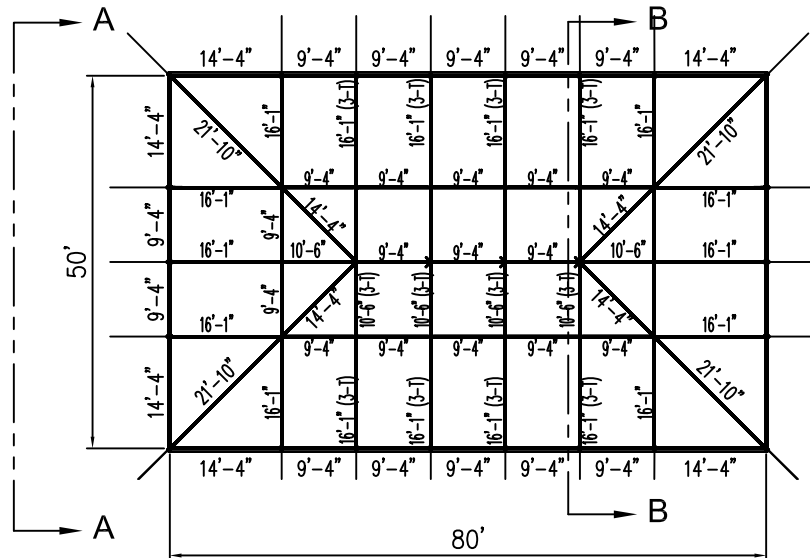

PLAN VIEW

ALL DATA AND INFORMATION CONTAINED IN OR DISCLOSED BY THIS DOCUMENT IS CONFIDENTIAL AND PROPRIETARY INFORMATION OF AZTEC TENTS AND ALL RIGHTS THEREIN ARE EXPRESSLY RESERVED. BY ACCEPTING THIS MATERIAL THE RECIPIENT AGREES THAT THIS MATERIAL AND INFORMATION CONTAINED THEREIN IS HELD IN CONFIDENCE AND IN TRUST AND WILL NOT BE COPIED, REPRODUCED WHOLE OR IN PART, NOR ITS CONTENTS REVEALED IN ANY MANNER TO OTHERS, EXCEPT TO MEET THE SPECIFIC PURPOSE FOR WHICH IT WAS DELIVERED.

AZTEC TENTS
 DESIGN & PRODUCTION
 2665 COLUMBIA ST. TORRANCE, CA. 90503
 (800) 228-3687 - FAX (310) 381-0722

JUMBOTRAC FRAME
 JUMBOTRAC / STANDARD
 50'W X 80'L
 PART NUMBER: ZXXXXXXX

REVISION HISTORY			
REV.	DESCRIPTION	BY:	DATE:
N/A	N/A	N/A	N/A
N/A	N/A	N/A	N/A
N/A	N/A	N/A	N/A
N/A	N/A	N/A	N/A
N/A	N/A	N/A	N/A

CONFIDENTIAL

ENGINEER: N/A DATE: 8/11/2016
 PAGE: 1 OF 1 DRAWN: HUGO.R

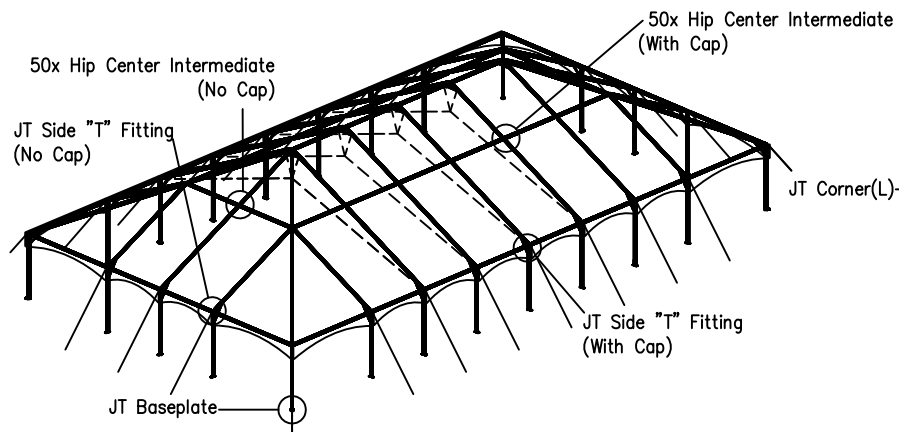

ISOMETRIC VIEW

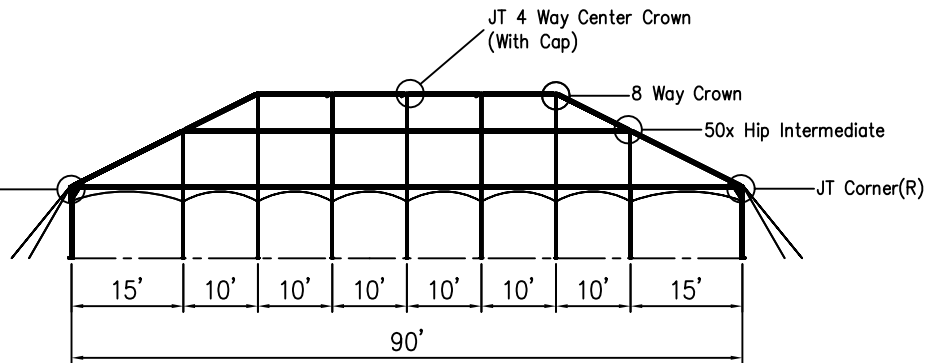

SIDE VIEW

50' x 90' JUMBOTRAC FRAME TENT

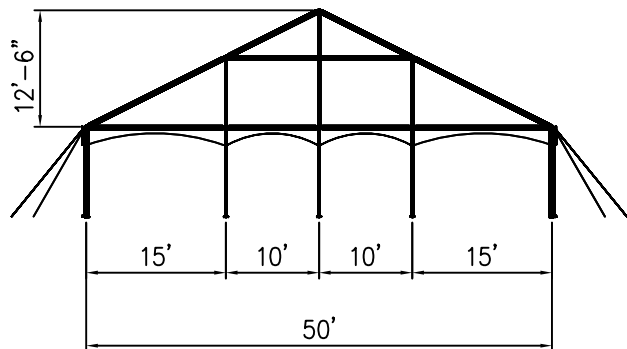

VIEW A-A

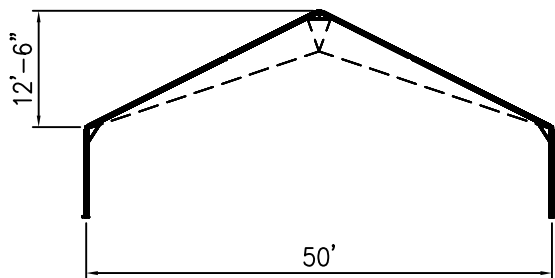

VIEW B-B

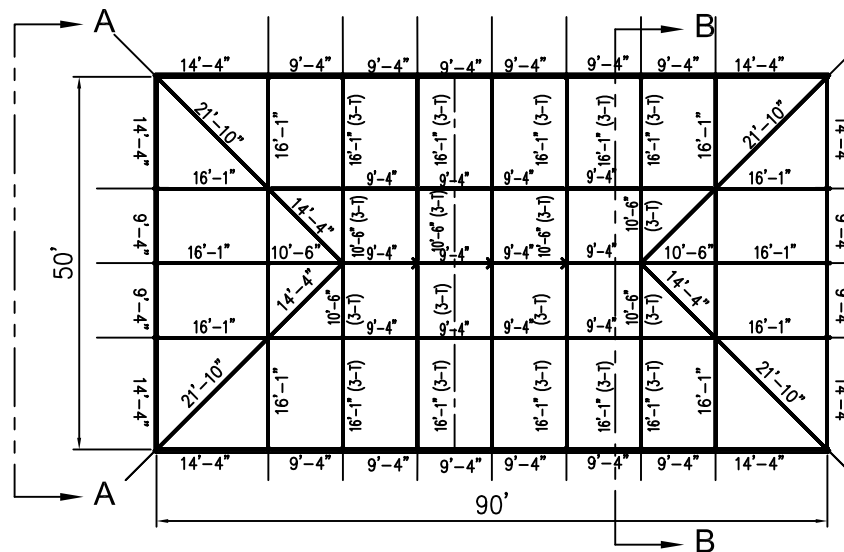

PLAN VIEW

ALL DATA AND INFORMATION CONTAINED IN OR DISCLOSED BY THIS DOCUMENT IS CONFIDENTIAL AND PROPRIETARY INFORMATION OF AZTEC TENTS AND ALL RIGHTS THEREIN ARE EXPRESSLY RESERVED. BY ACCEPTING THIS MATERIAL THE RECIPIENT AGREES THAT THIS MATERIAL AND INFORMATION CONTAINED THEREIN IS HELD IN CONFIDENCE AND IN TRUST AND WILL NOT BE COPIED, REPRODUCED WHOLE OR IN PART, NOR ITS CONTENTS REVEALED IN ANY MANNER TO OTHERS, EXCEPT TO MEET THE SPECIFIC PURPOSE FOR WHICH IT WAS DELIVERED.

AZTEC TENTS
 DESIGN & PRODUCTION
 2665 COLUMBIA ST. TORRANCE, CA. 90503
 (800) 228-3687 - FAX (310) 381-0722

JUMBOTRAC FRAME
 JUMBOTRAC / STANDARD
 50'W X 90'L
 PART NUMBER: ZXXXXXXX

REVISION HISTORY			
REV.	DESCRIPTION	BY:	DATE:
N/A	N/A	N/A	N/A
N/A	N/A	N/A	N/A
N/A	N/A	N/A	N/A
N/A	N/A	N/A	N/A
N/A	N/A	N/A	N/A

CONFIDENTIAL

ENGINEER: N/A DATE: 8/11/2016
 PAGE: 1 OF 1 DRAWN: HUGO.R

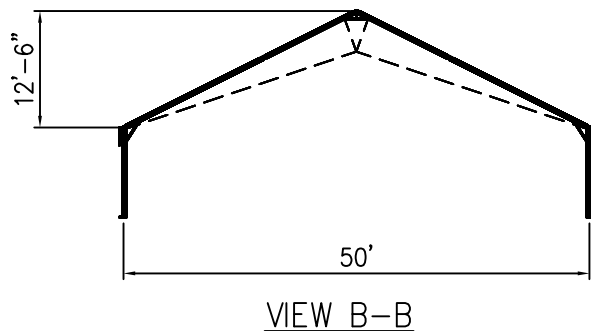
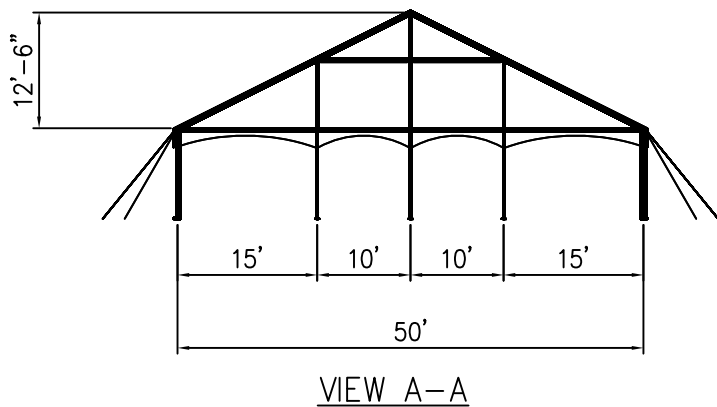
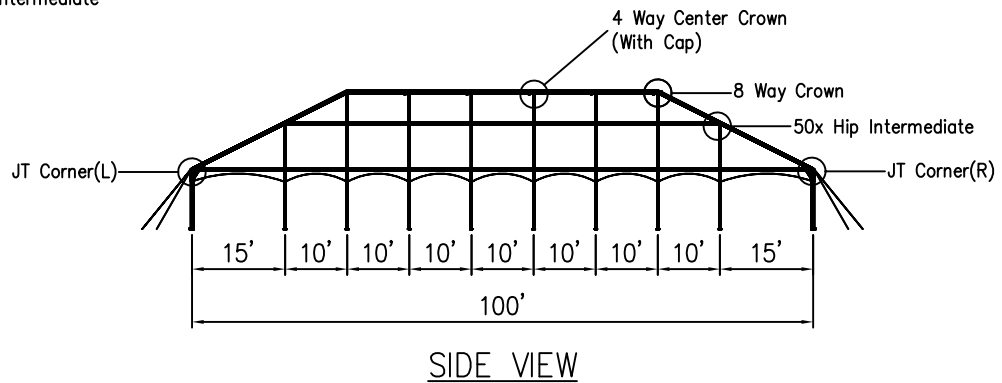
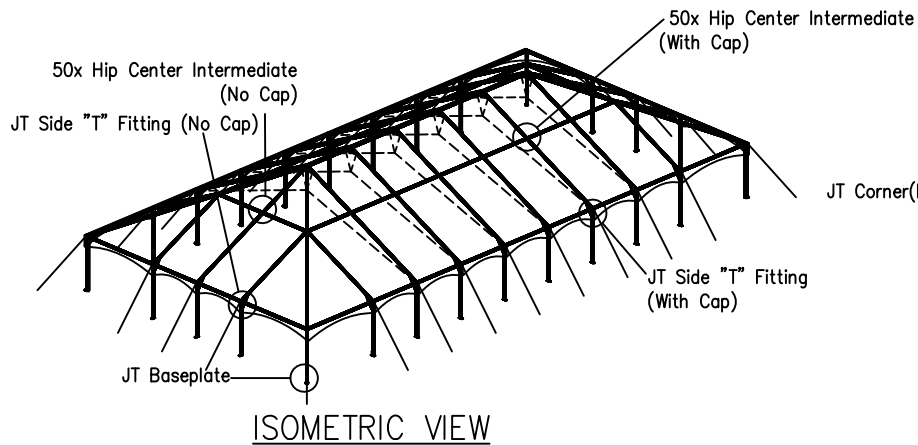

50' x 100' JUMBOTRAC FRAME TENT

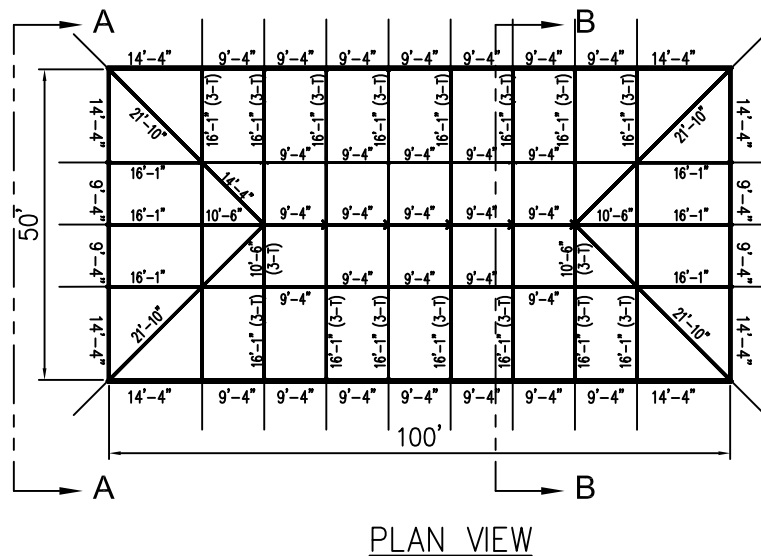

ALL DATA AND INFORMATION CONTAINED IN OR DISCLOSED BY THIS DOCUMENT IS CONFIDENTIAL AND PROPRIETARY INFORMATION OF AZTEC TENTS AND ALL RIGHTS THEREIN ARE EXPRESSLY RESERVED. BY ACCEPTING THIS MATERIAL THE RECIPIENT AGREES THAT THIS MATERIAL AND INFORMATION CONTAINED THEREIN IS HELD IN CONFIDENCE AND IN TRUST AND WILL NOT BE COPIED, REPRODUCED WHOLE OR IN PART, NOR ITS CONTENTS REVEALED IN ANY MANNER TO OTHERS, EXCEPT TO MEET THE SPECIFIC PURPOSE FOR WHICH IT WAS DELIVERED.

AZTEC TENTS
DESIGN & PRODUCTION
2665 COLUMBIA ST. TORRANCE, CA. 90503
(800) 228-3687 - FAX (310) 381-0722

JUMBOTRAC FRAME
JUMBOTRAC / STANDARD
50'W X 100'L
PART NUMBER: ZXXXXXX

REVISION HISTORY			
REV.	DESCRIPTION	BY:	DATE:
N/A	N/A	N/A	N/A
N/A	N/A	N/A	N/A
N/A	N/A	N/A	N/A
N/A	N/A	N/A	N/A
N/A	N/A	N/A	N/A

CONFIDENTIAL

ENGINEER: N/A DATE: 8/12/2016
PAGE: 1 OF 1 DRAWN: HUGO.R

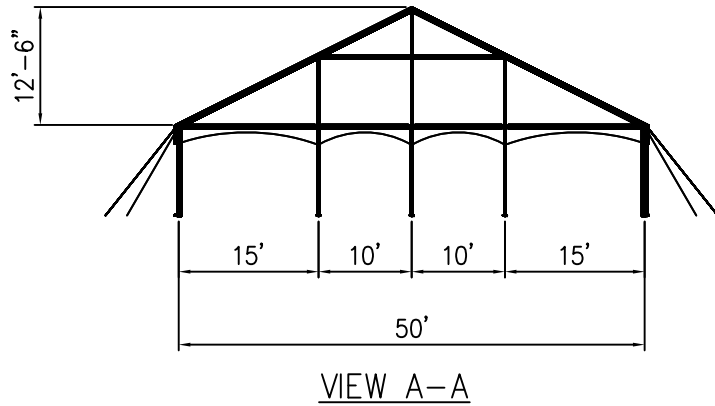
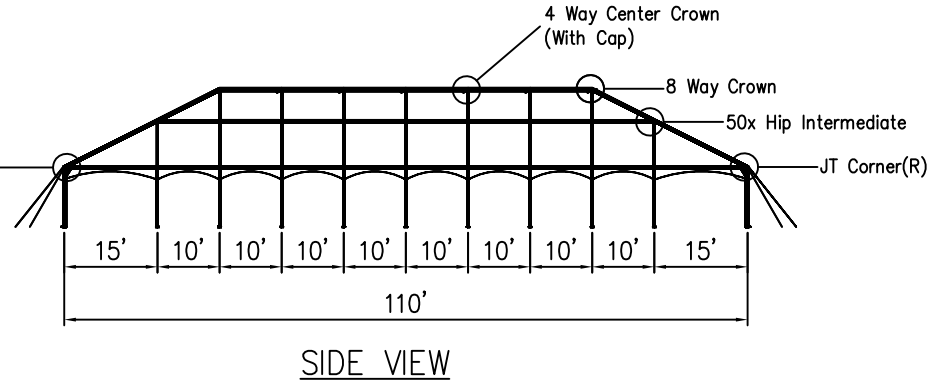
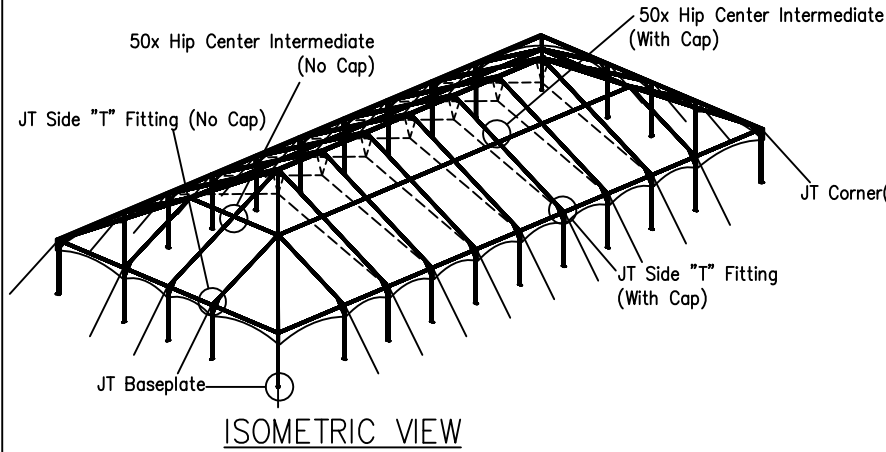

50' x 110' JUMBOTRAC FRAME TENT

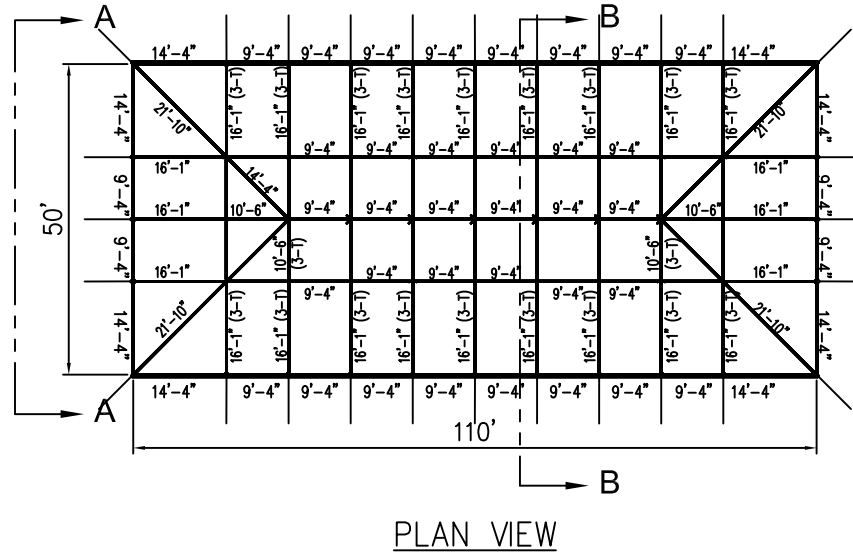
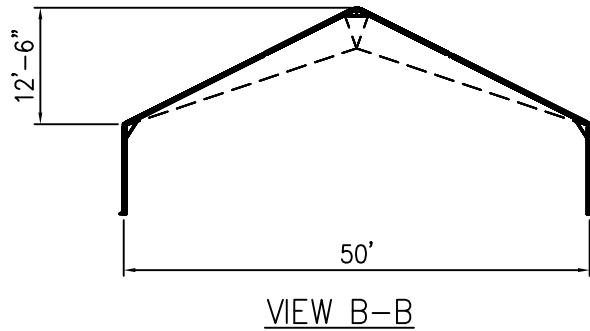

ALL DATA AND INFORMATION CONTAINED IN OR DISCLOSED BY THIS DOCUMENT IS CONFIDENTIAL AND PROPRIETARY INFORMATION OF AZTEC TENTS AND ALL RIGHTS THEREIN ARE EXPRESSLY RESERVED. BY ACCEPTING THIS MATERIAL THE RECIPIENT AGREES THAT THIS MATERIAL AND INFORMATION CONTAINED THEREIN IS HELD IN CONFIDENCE AND IN TRUST AND WILL NOT BE COPIED, REPRODUCED WHOLE OR IN PART, NOR ITS CONTENTS REVEALED IN ANY MANNER TO OTHERS, EXCEPT TO MEET THE SPECIFIC PURPOSE FOR WHICH IT WAS DELIVERED.

AZTEC TENTS
 DESIGN & PRODUCTION
 2665 COLUMBIA ST. TORRANCE, CA. 90503
 (800) 228-3687 - FAX (310) 381-0722

JUMBOTRAC FRAME
 JUMBOTRAC / STANDARD
 50'W X 110'L
 PART NUMBER: ZXXXXXXX

REVISION HISTORY			
REV.	DESCRIPTION	BY:	DATE:
N/A	N/A	N/A	N/A
N/A	N/A	N/A	N/A
N/A	N/A	N/A	N/A
N/A	N/A	N/A	N/A
N/A	N/A	N/A	N/A

CONFIDENTIAL

ENGINEER: N/A DATE: 8/12/2016
 PAGE: 1 OF 1 DRAWN: HUGO.R

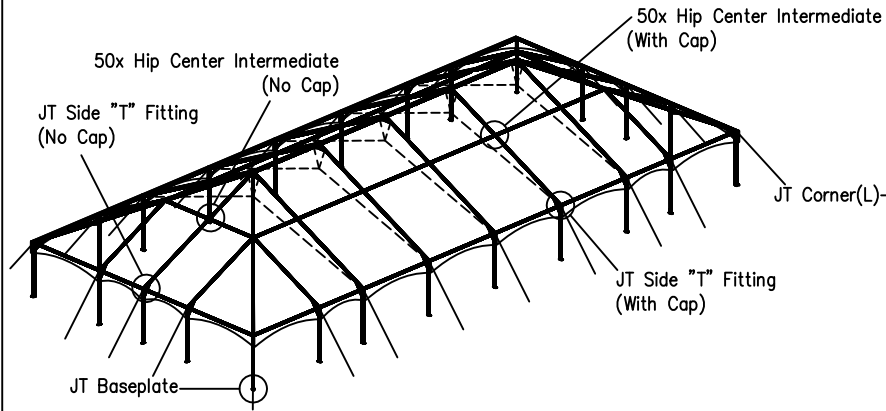

ISOMETRIC VIEW

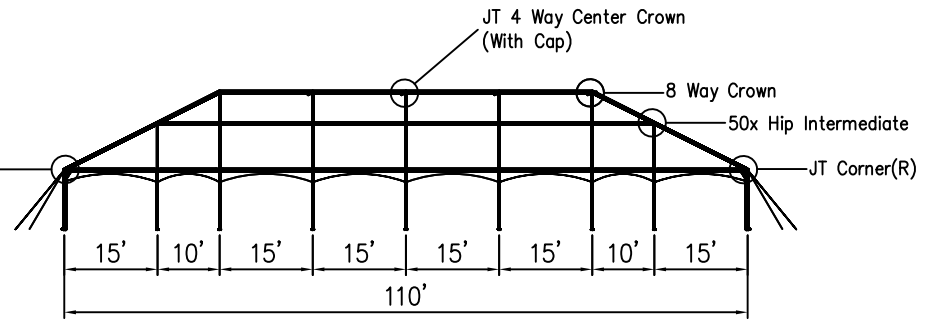

SIDE VIEW

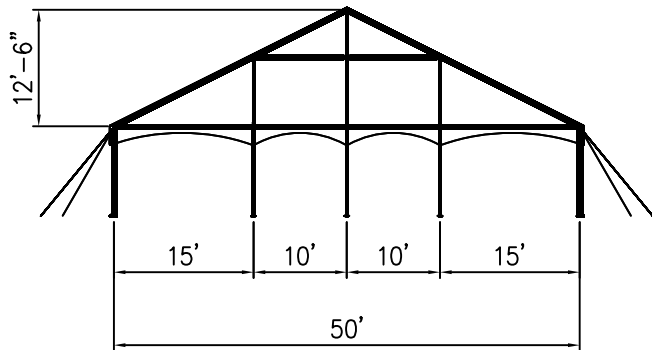

VIEW A-A

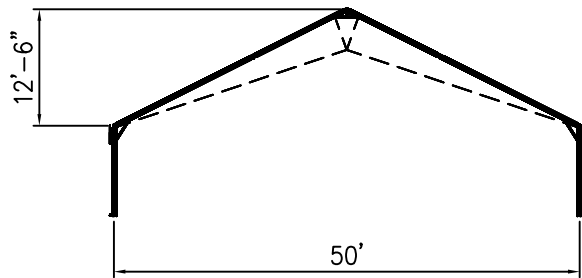

VIEW B-B

50' x 110' JUMBOTRAC FRAME TENT

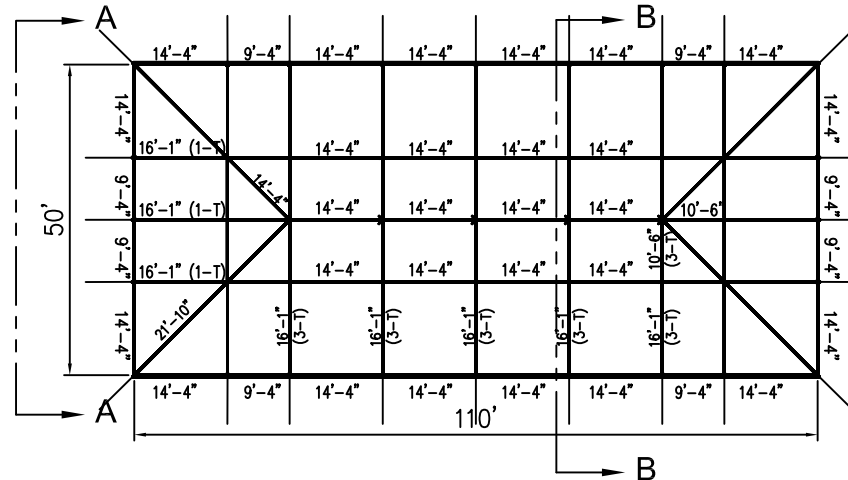

PLAN VIEW

ALL DATA AND INFORMATION CONTAINED IN OR DISCLOSED BY THIS DOCUMENT IS CONFIDENTIAL AND PROPRIETARY INFORMATION OF AZTEC TENTS AND ALL RIGHTS THEREIN ARE EXPRESSLY RESERVED. BY ACCEPTING THIS MATERIAL THE RECIPIENT AGREES THAT THIS MATERIAL AND INFORMATION CONTAINED THEREIN IS HELD IN CONFIDENCE AND IN TRUST AND WILL NOT BE COPIED, REPRODUCED WHOLE OR IN PART, NOR ITS CONTENTS REVEALED IN ANY MANNER TO OTHERS, EXCEPT TO MEET THE SPECIFIC PURPOSE FOR WHICH IT WAS DELIVERED.

AZTEC TENTS
 DESIGN & PRODUCTION
 2665 COLUMBIA ST. TORRANCE, CA. 90503
 (800) 228-3687 - FAX (310) 381-0722

JUMBOTRAC FRAME
 JUMBOTRAC / STANDARD
 50'W X 110'L
 PART NUMBER: ZXXXXXXX

REVISION HISTORY			
REV.	DESCRIPTION	BY:	DATE:
N/A	N/A	N/A	N/A
N/A	N/A	N/A	N/A
N/A	N/A	N/A	N/A
N/A	N/A	N/A	N/A
N/A	N/A	N/A	N/A

CONFIDENTIAL

ENGINEER: N/A DATE: 9/22/2016
 PAGE: 1 OF 1 DRAWN: HUGO.R

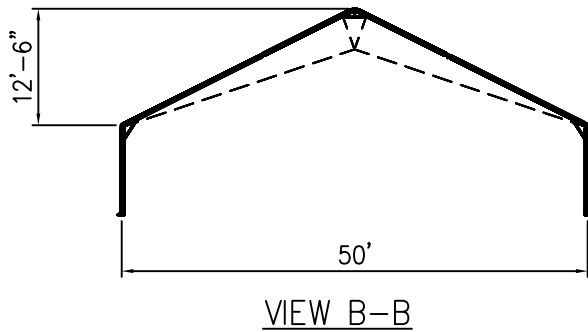
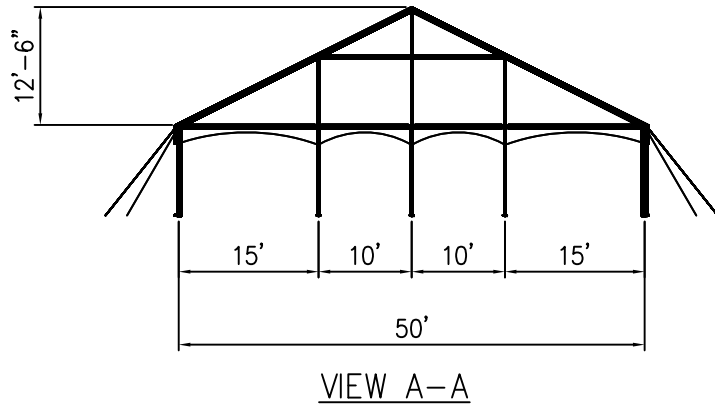
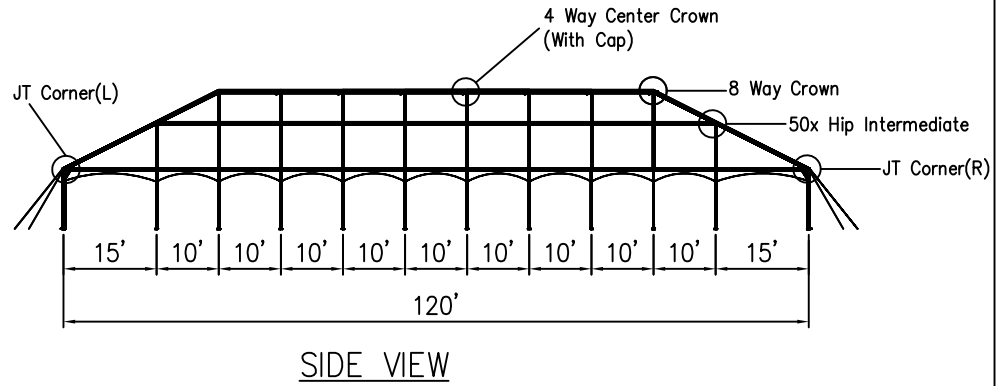
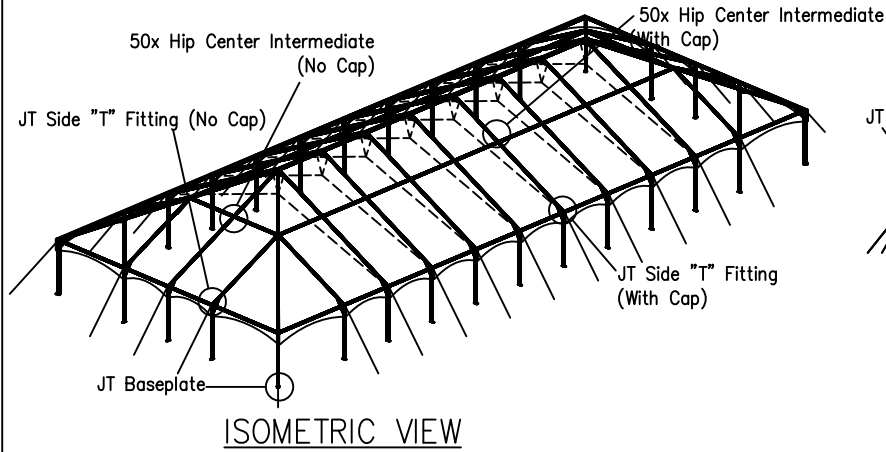

50' x 120' JUMBOTRAC FRAME TENT

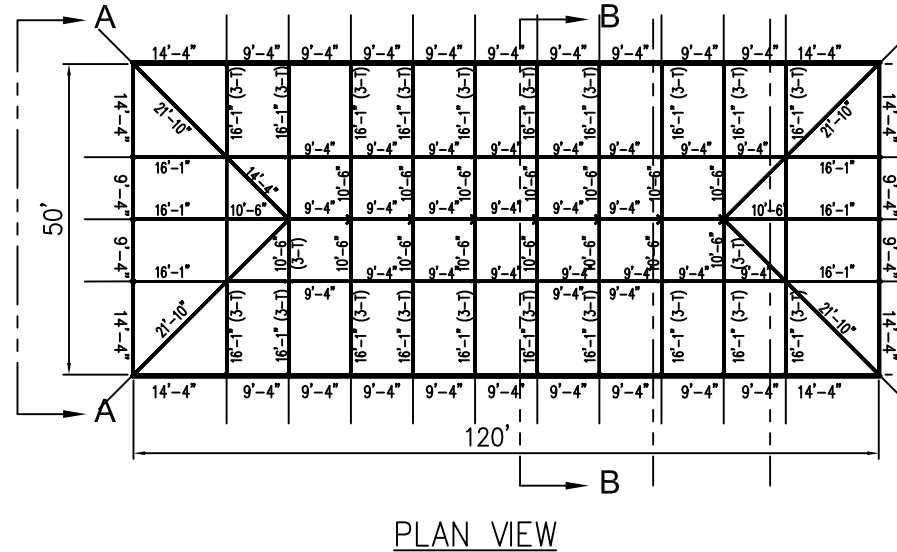

ALL DATA AND INFORMATION CONTAINED IN OR DISCLOSED BY THIS DOCUMENT IS CONFIDENTIAL AND PROPRIETARY INFORMATION OF AZTEC TENTS AND ALL RIGHTS THEREIN ARE EXPRESSLY RESERVED. BY ACCEPTING THIS MATERIAL THE RECIPIENT AGREES THAT THIS MATERIAL AND INFORMATION CONTAINED THEREIN IS HELD IN CONFIDENCE AND IN TRUST AND WILL NOT BE COPIED, REPRODUCED WHOLE OR IN PART, NOR ITS CONTENTS REVEALED IN ANY MANNER TO OTHERS, EXCEPT TO MEET THE SPECIFIC PURPOSE FOR WHICH IT WAS DELIVERED.

AZTEC TENTS
 DESIGN & PRODUCTION
 2665 COLUMBIA ST. TORRANCE, CA. 90503
 (800) 228-3687 - FAX (310) 381-0722

JUMBOTRAC FRAME
 JUMBOTRAC / STANDARD
 50'W X 120'L
 PART NUMBER: ZXXXXXX

REVISION HISTORY			
REV.	DESCRIPTION	BY:	DATE:
N/A	N/A	N/A	N/A
N/A	N/A	N/A	N/A
N/A	N/A	N/A	N/A
N/A	N/A	N/A	N/A
N/A	N/A	N/A	N/A

CONFIDENTIAL

ENGINEER: N/A DATE: 8/12/2016
 PAGE: 1 OF 1 DRAWN: HUGO.R

