

PRODUCT MANUAL



If YOU can IMAGINE it... WE can BUILD it

SERIES 2200

WARNING

This tent product is not intended to be used as a shelter from severe weather. Evacuate immediately if threatening weather occurs (or is forecasted) or any condition arises concerning the safe use of this product. Threatening weather includes electrical storm systems, moderate to high wind (excess of 38mph), heavy rains, snow, or any condition that raises any doubt to the structural integrity of the tent

CAUTION

The installation of electrical, plumbing, lighting, appliances and/or HVAC equipment are not covered within this manual. Users/Installers shall follow local code requirements for the installation of these items using certified personnel. AztecTents shall be indemnified and held harmless from any such use or injury resulting from its use.

Important Safety Information

Proper personnel safety equipment should be worn at all times during the installation of any tenting products.

Hard Hat

Safety Glasses

Work Gloves

Long Pants

Steel Toe Boots

OSHA Approved Harness and restraint system (for off ground activities)

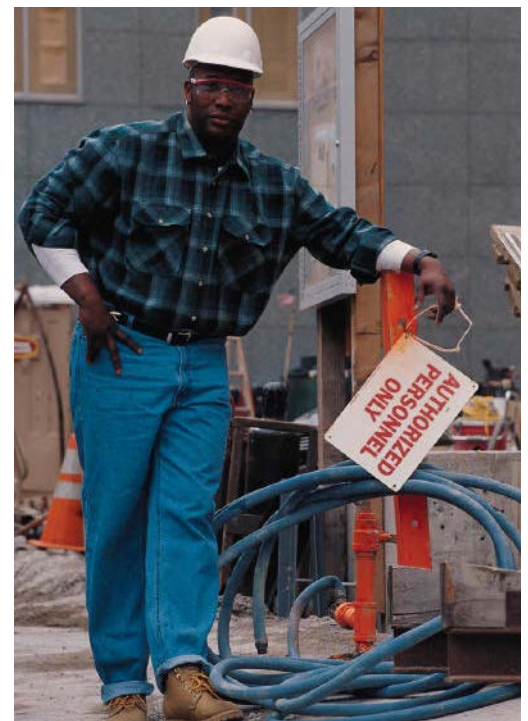

Thank you for your recent purchase from Aztec Tents. The following procedures will help you through your installation. If you ever run into problems with the installation of your Aztec Tent give one of our sales/service professionals a call. Other product specific information, contact information, diagrams, and other operational support is available on our web site at www.aztectents.com.

Contents

General Care & Guidelines	
General Fabric Care & Maintenance	4
General Hardware Care & Maintenance	5
Fabric Flame Retardant Information	5
Anchoring	5-6
Pre-Installation Guidelines	6
General Installation Guidelines	6
Post Installation Guidelines- Maintenance	7
Safety & Evacuation Planning	7
General Take Down/Removal Guidelines	7
Special Care for Unsupported Clear Fabric	8
Other Resources	8
Tools Required for Installation	8
Optional Items & Accessories Available	8
Installation Procedure	
Hip End Design	9-13
Gable End Design	14-18
Diagrams	19-41
Parts Images	42-43
Engineering Specifications	44-46
Replacement Parts	47

Questions? Call us.

Aztec Tents

2665 Columbia Street
Torrance, CA 90503 USA
Direct (310) 347-3010
Toll Free (800) 228-3687
Fax (310) 381-0722

V.04172023

General Fabric Care & Maintenance

The vinyl fabric developed for this tent system requires specific attention during installation, cleaning, and storage to maintain its maximum life span. Please follow the following care and maintenance guidelines provided for this product.

GROUND CLOTHS:The usage of ground covering material under the tent during installation and dismantle will protect the tent fabric from soiling and from minor surface abrasions. A ground cloth can also help keep the tent top dry if the ground surface (i.e. dirt, grass, etc.) is wet during the installation or dismantle.

MILDEW TREATMENT:The fabric is pretreated with mildew inhibitors that help prevent the growth and spreading of mildew and fungus. Although treated, proper care should be given to prevent potential growth. If you see mildew wipe it away immediately with a clean towel and diluted soap solution. Never fold your fabric for storage if the fabric is even slightly wet. Mold/Mildew spores in the air and on the ground will come in contact with the fabric while installed. To grow, all the mildew needs is moisture and some source of food (often found in dirt that might be on the tent). Your best bet is to keep your fabric clean and dry to prevent mildew growth.

FABRIC CLEANING:The best way to clean the vinyl tent fabric is with a soft towel or soft bristled brush immersed in a diluted solution of warm water and our tent cleaning solution. A diluted and mixed solution of a tablespoon of traditional dish soap with a gallon of warm water will also work, but extra caution should be placed on insuring that this cleaning solution is thoroughly rinsed from the fabric, especially with clear vinyls (See special notes on working with clear vinyls).

You will need a large, smooth, flat space slightly larger than the section of fabric. This space should be covered with a ground protecting layer to avoid damaging the tent membrane when moving in the washing area. Small impediments, sharp objects and rough surfaces all have the potential to damage the membrane you are trying to clean.

Follow the instructions for the proper dilution ratio of your cleaning product. Apply the diluted solution directly to the fabric using 1) a towel immersed in the solution, or 2) a spray bottle or larger pressurized spraying apparatus to evenly cover the fabric with the solution. Let this sit on the fabric for about one minute to allow the mixture to penetrate the fabric. Using a soft towel or soft bristled polypropylene brush (some can be mounted to a long handle to allow you to stand while working), gently work the cleaner into the fabric using only mild pressure. While harder bristled brushes can work, they will end up microscopically scratching the fabric, potentially permanently damaging the fabric and making it harder to clean the next time. The process of hand cleaning the fabric will allow you to apply only enough diluted solution to get the fabric clean. This will help limit the amount of water placed on the fabric to expedite drying time. Never allow the tent cleaner to dry on the fabric. For this reason, larger tents might be better to clean in sections. Once the cleaning is complete be sure to rinse away any cleaning solution completely from the tent membrane.

Full immersion of the fabric in water is not recommended. The use of commercial front loading or top loading washing machines is not recommended and will void the warranty of the fabric. These machines cause an excessive amount of stress to the fabric and can force water into the fabric causing increased occurrences of mildew growth and shorten the life of the fabric. As with any cleaning, the fabric should be hung to dry completely before folding and storage. Cleaners that include chlorine bleach, and/or any petroleum based solvents will degrade the fabric, discolor the fabric and shorten its life span.

If you have a difficult stain that cannot be removed with traditional cleaning, please consult with your sales person before trying any other chemicals that might end up damaging the material further. Do not use other chemicals or cleaners unless instructed by your sales professional.

FABRIC DRYING:The best way to dry the vinyl tent fabric is to hang-dry in a low humidity environment. Circulating air around the surface of the hanging fabric with the use of fans will also speed the drying process and improve drying time in more humid environments. Please also assure that subassemblies and other components within the tent system are dry before folding. These subassemblies can be reinforcements, lace lines, webbing, rope, thread, and/or any other part that is permanently affixed to the main tent membrane. The use of commercial drying equipment and any drying using heat will void the warranty of the fabric. **DO NOT STORE YOUR FABRIC WET.** Fabric folded and stored wet will mildew.

TENSIONING: Do not over tension your tent fabric during installation, use, or removal. Over tensioning can cause permanent damage to the tent membrane. The most obvious sign of over tensioning would be stress wrinkles at the tension points. Be sure to confirm that your frame/pole components match the tent design. In cases where the ground is not level, over tensioning is possible by trying to force the tent to dimension.

STORAGE RECOMMENDATIONS:The fabric for the tent system shall be stored dry in a cool, dry place in the protective storage bags included with your purchase. Other types of bags are acceptable as long as they can protect the fabric from the environmental elements of the storage area. Optimal storage temperature is between 50°F and 70°F.

INSPECTION: Prior to each use, each component of the tent system needs to be thoroughly inspected to assure its structural stability has not been compromised. Fabric components that are ripped, torn, frayed, or damaged shall be immediately replaced and not used. Structural components of the fabric membrane are the most critical including but not limited to the main fabric membrane, structural reinforcements and webbing, web termination plates/rings/fasteners, and connection points from fabric panel to fabric panel or connection points between the fabric panel and the hardware support system.

General Hardware Care & Maintenance

The hardware components developed for this tent system requires specific attention during installation, cleaning, and storage to maintain its maximum life span. Please follow the following care and maintenance guidelines provided for this product.

OXIDATION:The hardware components for this tent system have been supplied to you with specialty coatings to help limit oxidation. With usage, these coatings will need to be maintained in order to limit oxidation and for the product reach its full intended lifespan. With plated or powder coated steel components, any rust should be removed immediately with a stiff wire brush and sprayed with either a galvanizing spray or durable paint to seal the steel from the elements. Anodized aluminum components will get scratched over time and these scratched areas can develop a thin black oxidation common with mill finish aluminum. This black oxidation can cause staining to any fabric components that come in contact with the pole/component. Your best preventative measure will be to avoid scratching of the anodized coating by avoiding any sharp edges that might be come in contact with the aluminum member.

HARDWARE CLEANING: It is very important to keep your hardware components clean and free of dirt, oxidation, and other chemicals especially if those hardware components come into contact with any fabric components during installation, use, or take-down of your product. Any dirt, oxidation, or chemical on the surface of the hardware member can transfer the contaminant to the fabric causing permanent staining, or permanent damage to the fabric membrane. If hardware components are found to be soiled, wipe down immediately to remove the foreign matter.

STORAGE RECOMMENDATIONS:The hardware for the tent system shall be stored dry in a cool, dry place. Anodized aluminum component can be stored outside, but should be covered to prevent foreign matter from collecting on the components that might stain or damage the fabric membrane during installation or use. Any/all steel components shall be stored indoors in a dry/low humidity environment.

INSPECTION: Prior to and after each use, each component of the tent system needs to be thoroughly inspected to assure its structural stability has not been compromised. Hardware components that are bent, cracked, frayed, or damaged shall be immediately replaced and not used. Specific attention should be paid toward any devices used for anchoring including ratchets, ropes, cables, and web straps.

Fabric Flame Retardancy

All vinyl fabric used in the production of our tents, walls, and accessories are certified flame retardant per per NFPA 701, Canadian CAN-ULC-S109-03, British Standard BS 7837:1996, and are registered with the California State Fire Marshal. These vinyl products are produced so that they are inherently flame retardant, and thus will never require additional applications of flame retardant chemicals.

Every section of fabric produced by Aztec Tents contains a label identifying its flame resistance characteristics and date produced. This label matches a hard copy of the flame certificate that is mailed to you after receipt of your goods.

If at any time you need to be issued a duplicate flame certificate, you can request one from our customer service representatives. Please be sure to have the invoice number and date of production available when requesting duplicate flame certificates.

Anchoring

All anchoring locations must be laid out accurately as described in the manual and diagrams contained within (in advance of laying out the fabric) to a tolerance of +/- 4" in any direction (right or left, forward or back, up or down, etc.) All column base locations must be laid out to a tolerance of +/- 3" in any direction for any standard supported tents and within a tolerance of +/- .5" for any product utilizing keder channels.

A wide variety of ground anchoring devices are commonly used. Soil conditions and resulting ground anchor holding capacities vary from site to site, and can vary within a particular site. The Owner and/or Installer of the tent is fully responsible for assuring that the selection and installation of the anchoring devices is adequate to resist the pull out loads specified in the product manual.

Reduced anchor performance can occur under wet soil conditions and needs to be accounted for. Care should be taken that water is not allowed to drain or collect near anchors.

Anchoring device holding capacity can be developed using a single large device, or by using multiple smaller devices.

Ensure that the anchors installed are adequate to resist the pull out loads shown. Actual testing of some individual anchors to 75% of the anchor pull-out load is recommended.

Additional installation and anchoring information entitled "The IFAI Procedural Handbook For The Safe Installation And Maintenance Of Tentage" is published by the Tent Rental Division of the Advanced Textiles Association (ATA).

Anchoring Tie Downs

Although we use high quality thread and webbing for all of our sewn tie-down components, ultraviolet light from the sun will slowly breakdown these fibers over time. Chemicals, cleaners, or other products should not be used on webbing tie-down components as its use might accelerate this aging process. Damaged, abraded, cut, or frayed straps should never be used.

Additionally, these straps should never be used for other tie-down applications other than securing the tent for which they were purchased (i.e. securing equipment on a pallet, truck, or trailer). Seasonal installations should replace tie-down straps annually or sooner if any damage is noted. Other straps used in short term applications should be tested periodically to assure that they meet the intended working load for their design. Straps shall expire 5 years from the date of their manufacture (noted on the item tag) and shall not be used.

Pre-Installation Guidelines

Correct field installation of this tent system requires diligence and considerable skill and expertise which can be obtained only through the proper field training and experience of a professional rental tent supervised installation crew. This is instrumental to obtaining the optimal structural behavior of the tent.

- Obtain any required permits or inspections needed by local codes and regulations.
- Clear the site to prepare for the planned activity.
- Check for sub grade utilities before installing any anchoring devices.
- Check for any overhead obstructions that might interfere with the tent installation. Do not install any tent within 50' of any overhead utilities, power lines, or other obstructions. Installation under or within close proximity to trees should be avoided.
- Locate the public circulation routes with clearance from anchors around the exterior of the site. Identify clearly.
- Use drop cloths to prevent soiling or damaging the fabric membrane.
- Pad and tape objects with sharp projections which will remain on site under the tent.
- Cover any sharp edges on anchoring devices with protective material

General Installation Guidelines

Each component of the tent should be inspected at the beginning of installation for visual signs of damage by the installer. All damaged materials should be repaired or replaced immediately.

The weather should be carefully considered by the Owner and/or the Installer before raising the tent since the hardware and fabric cannot transmit design wind loads or shed rainwater loads (potential ponding) when it is not fully anchored, installed, and/or tensioned. It is recommended that installation or removal of the fabric members be performed when the wind speed is less than 15 mph. The decision to raise or lower the fabric of the tent should be the responsibility of the experienced rental tent installation supervisor based upon conservative life safety considerations and judgement.

Adequate and appropriate installation and maintenance procedures are necessary to achieve and sustain full design load capability for the tent. The Owner and/or Installer are fully responsible for assuring that the tent is properly installed and maintained.

Certification of this tent structure is valid only with the use of Aztec Tent supplied and assured components or those which meet or exceed the requirements of the design throughout the installation of this structure, with the exception of the anchoring devices which must be determined by the installation engineer.

Post Installation Guidelines / Maintenance

Each component of the tent should be inspected at the end of installation for visual signs of damage by the installer. Additionally, an inspection should be performed after any severe weather/wind events that might have affected the overall integrity of the design. All damaged materials should be repaired or replaced immediately.

A variety of material and weather factors can result in fabric stretch, web belt stretch, rope stretch, mast base settling, changes to design geometry, etc. Changes to the design geometry of the tent and consequently the structural performance characteristics of the tent, can occur while the tent is in service and not attended by the professional installer. It is recommended that a maintenance agreement be arranged between the Client/User of the tent and the Installer involving periodic inspections and adjustments.

If rainwater ponding occurs at any point on the fabric, evacuate the tent, remove the water, and adjust the tie back rope/web prestress tension and/or fabric tensioning over the frame back to its design geometry to achieve positive drainage.

It is understood and expected that some damage to the fabric membrane and/or non structural components may occur in conditions below the overall design wind velocity rating of the tent system. This damage may result in components requiring repair or replacement as necessary.

Safety & Evacuation Planning

It is the responsibility of the Owner and/or the Installer to warn the User and or Occupants of the tent system that this product is not intended to be used as a shelter from severe weather. Aztec assumes no liability for such use. An evacuation and communication plan for the area covered within this tented space is imperative and shall be thoroughly communicated to all users and potential occupants of the tent. Severe weather including electrical storm systems, moderate to severe wind, heavy rains, snow, or any condition that raises any doubt to the structural integrity of the tent are immediate signs that an evacuation is necessary. Severe bodily injury and/or death can occur. A best practices document published by the American Rental Association covering this topic can be downloaded at: http://aztectent.com/webfm_send/151

Common signs that warrant the immediate evacuation of this tent:

- Any movement, displacement, or failure of any of the anchoring devices or support hardware.
- Any component failure in part or whole
- Any tear or puncture in the fabric membrane
- Any forecasted moderate to severe weather condition
- Any collection or accumulation of snow or ice on the tent
- Strong winds causing movement and/shifting of the tent or tent support structure
- Strong winds causing small branches to be ripped from trees
- Any lightning or electrical storms
- Hail or frozen precipitation any larger than pea size
- Any fire or smoke within close proximity of the tent
- Any smell of gas, exhaust, or other odor from any combustible material

In the event of forecasted severe weather, hurricane, or other such early warning, it is recommended to immediately evacuate the tent and time permitting take down the tent and remove from the site.

General Take Down / Removal Guidelines

The weather should be carefully considered by the Owner and/or the Installer before lowering the tent since the hardware and fabric cannot transmit design wind loads or shed rainwater loads (potential ponding) when it is not fully anchored, installed, and/or tensioned. It is recommended that installation or removal of the fabric members be performed when the wind speed is less than 15 mph. The decision to raise or lower the fabric of the tent should be the responsibility of the experienced rental tent installation supervisor based upon conservative life safety considerations and judgement.

Unless otherwise noted in the procedures that follow, the removal of this tent system shall follow the same procedures outlined but in the reverse order.

Once unassembled, each component of the system should be inspected for any signs of visual damage by the installer. All damaged materials should be marked or identified so that repair or replacement of these materials can occur prior to the next use of the product.

Special Care For Unsupported Clear Fabric

The clear fabric used in window style sidewalls, clear sidewalls, and clear tent tops needs to be managed differently than standard tent fabric. Polyester scrim is what gives standard tent fabric its strength, stability and durability. Laminated tent fabric enjoys the benefit of encasing this woven layer of rip-stop polyester between the layers of colored vinyl film. Clear vinyl does not enjoy those benefits. Because of this, clear vinyl has a very low tolerance to ultra violet ray exposure, wind, airborne particulate matter, hot or cold temperatures, elasticity due to wind and rain and handling. Any or all of these factors will cause clear fabric to under perform when compared to traditional tent fabric.

Exposure to ultra violet rays for an extended amount of time as will occur with time over the life of the product, will cause the fabric to appear milky or opaque. Putting away and storing damp or wet clear vinyl will result in a foggy hue in the clear film. Usually, this fogginess will disappear when the walls are left open to dry and warm up. Steady wind can whip clear vinyl back and forth and cause surface or through cracks in the fabric. Heat in excess of 85°F will cause clear vinyl to stretch and distort. Although our clear vinyl has a cold crack rating of near freezing, that rating is for a static environment. Any introduction of wind or manipulation by handling will cause failure (cracking like glass) in colder conditions. Use of clear fabric in temperatures less than 50°F should be avoided. Airborne particulate matter will abrade the surface and cause the finish to become less translucent.

Clear tent tops are also very susceptible to water ponding as they are highly elastic. If rain is forecasted during the use of these products it is recommended to take additional precautions and more frequent inspections throughout the duration of the rainfall to inspect for potential ponding on the roof fabric. If rainwater ponding occurs at any point on the fabric, evacuate the tent, remove the water, and adjust the tie back rope/web prestress tension and/or fabric tensioning over the frame back to its design geometry to achieve positive drainage.

Special attention should be paid to the cleaning of these items. Use only the softest towels when cleaning the clear membrane to avoid scratching the highly polished surface, and wipe dry to avoid water spots. Use standard diluted tent cleaning solution. **DO NOT USE OTHER CHEMICALS.** Optimal storage temperature is between 50°F and 70°F.

Other Resources

American Rental Association- www.ararental.org
Tent Rental Division of the Advanced Textiles Association

Tools Required for Installation

Sledge Hammer	For driving anchoring stakes
Canopy Jacks	For lifting Frame
Drop Cloths	For protecting fabric membrane
Pull Ropes	For pulling fabric membrane over roof
8' Ladder	General installation tool
Utility Knife	General installation tool
Tape Measure	General installation tool
Marking Paint/Chalk	Used to mark anchoring locations and tent boundaries

Optional Items & Accessories Available

JT Keder Feeder Set	Assists in feeding membrane panels into the keder track beams
Side Wall Panels	To enclose walls of tent
Raingutters	To collect and divert water away from connecting tent entrances
Decorative Liners	To add decorative look and hide most rafter framework
Double Valance	Makes installation of traditional sidewall and gutters easier
Canopy Doors	To add easily accessible means of egress to and from the tent
JT Wall Tension Bars	To secure the bottoms of the walls from moving in breezy conditions
Additional Anchors	Additional anchors used to secure the tent system

Installation Procedure:

Step 1:

Square the tent area. Use the below squaring diagram to determine the diagonal or "C" Dimension your tent installation. To calculate your own squaring dimension for your width/length combination use the formula $A^2+B^2=C^2$.

		WIDTH OF TENT							
		20'	30'	40'	50'	60'	80'	100'	120'
LENGTH OF TENT	20	28'3"	36'1"	44'9"	53'10"	63'3"	82'6"	102'	121'8"
	30	36'1"	42'5"	50'	58'4"	67'1"	85'5"	104'5"	123'8"
	40	44'9"	50'	56'7"	64'	72'1"	89'5"	107'8"	126'6"
	50	53'10"	58'4"	64'	70'9"	78'1"	94'4"	111'10"	130'
	60	63'3"	67'1"	72'1"	78'1"	84'10"	100'	116'7"	134'2"
	70	72'10"	76'2"	80'7"	86'	92'2"	106'4"	122'1"	138'11"
	80	82'6"	85'5"	89'5"	94'4"	100'	113'2"	128'1"	144'3"
	90	92'2"	94'10"	98'6"	102'11"	108'2"	120'5"	134'6"	150'
	100	102'	104'5"	107'8"	111'10"	116'7"	128'1"	141'5"	156'2"
	120	121'8"	123'8"	126'6"	130'	134'2"	144'3"	156'2"	169'8"
	130	131'6"	133'5"	136'	139'3"	143'2"	152'8"	164'	176'11"
	140	141'5"	143'2"	145'7"	148'8"	152'4"	161'3"	172'	184'5"
150	151'4"	153'	155'3"	158'1"	161'7"	170'	180'3"	192'1"	
160	161'3"	162'9"	164'11"	167'7"	170'11"	178'11"	188'8"	200'	
170	171'2"	172'8"	174'8"	177'2"	180'3"	187'11"	197'3"	208'1"	
180	181'1"	182'6"	184'5"	186'10"	189'9"	197'	205'11"	216'4"	
190	191'1"	192'4"	194'2"	196'6"	199'3"	206'2"	214'9"	224'9"	
200	201'	202'3"	204'	206'2"	208'10"	215'5"	223'7"	233'3"	

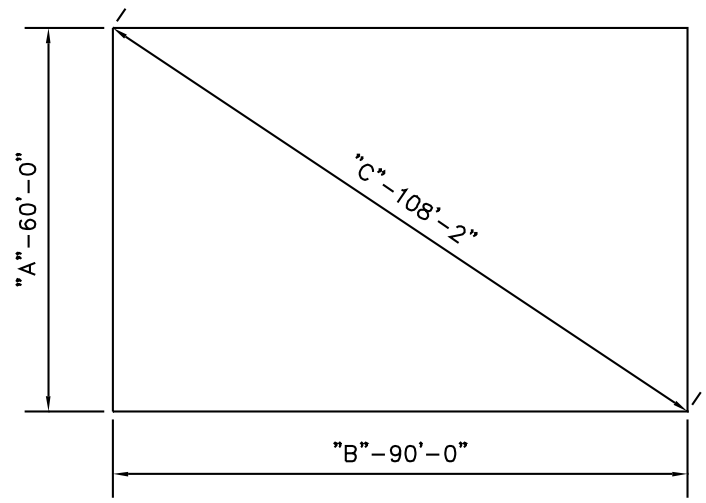

Step 2:

Mark on the ground with chalk or spray paint the location of the leg and center poles. These locations are identified on the drawing to the right. All legs are spaced 10' on center around the perimeter of the tent. Refer to the diagrams included with this manual for the pole locations for the various sizes.

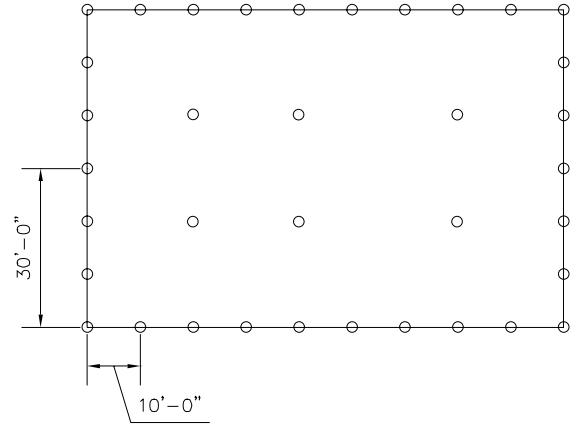

Step 3:

Mark on the ground the location of each staking bar. The dimensions shown indicate the center of each bar. Each bar is placed equal distance away from each leg as the height of the leg. Note: refer to the included diagrams for proper anchor placement recommendations.



Step 4:

Drive the anchoring stakes. Place the staking ratchet under the center hole of the staking bar and insert the 1" x 42" double headed stake through both holes. Drive the stake with a sledge hammer, air hammer, or gas powered hammer completely into the ground until it makes contact with the staking bar. Continue driving the outer two stakes through the staking bar into the ground. Continue with all stakes. The final anchored product will look like the picture shown to the right.

NOTE: Soil conditions will vary from site to site. Additional anchoring may be needed under certain conditions.



Step 5:

Layout a ground cloth over the ground in the tent area. This will protect the tent top fabric. Position all of the center poles on top of the ground cloth so that the pin of the center pole lays directly above the mark you made on the ground for the center pole location. The center poles should all lay in the same direction so that the bottom points toward the end of the tent.



Step 6:

Begin lacing the tent sections together. See to illustration to the right for proper lacing technique.

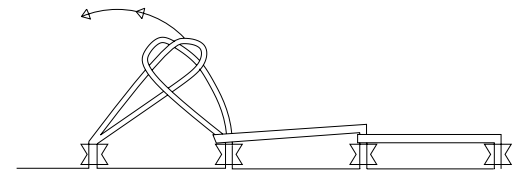

Step 7:

Proper lacing technique shown to the right, using both hands to push the lace of the under panel through the grommet of the upper panel and pulling down to the next set of grommet and lace.



Step 8:

When you come to the end of the lace line the lace is terminated with a double knot as shown to the right.



Step 9:

Now seal the rain flap over the lace connection. Be sure to lay the flap flat and smoothly and snap the hooks on the edge of the flap to the running on the adjacent section.

Step 10

Connect snaps along perimeter edge to hold the connection at the eave secure.



Step 11:

Begin installing the legs of the tent. First insert the pin of the corner leg pole through the plate on the corner of the tent. Attach the corresponding web guys to the plate on the corner connection and apply enough tension with the ratchet to make the leg almost vertical.



Step 12:

Continue down the length of the tent installing legs and lightly tensioning the web guys. Continue with the other long side of the tent, starting at the corner and working down the tent.



Step 13:

Proper tensioning technique shown with socket wrench (not included) to apply enough tension to the leg pole to keep it from falling over.



Step 14:

Photo showing all of the leg poles installed and moderately tensioned.



Step 15:

Starting with the first center pole on the end of the tent slide a 1"x 42" stake through the hole approximately 36" up from the bottom of the center pole and set stake on the forks of a forklift as shown. Laborers will need to access the top of the center pole by pushing up the fabric and walking toward the top of the center pole. Using manpower the top of the center pole is lifted vertically as the forklift gently moves forward. Once the pole is supported by the lift and the tension of the fabric is holding it off the ground the laborers should move away from the center pole as the lift continues to slowly move forward.



CAUTION: The top of the center pole is surrounded by an excess of fabric when it low to the ground. Be very careful that the fabric on the outside of the tent does not catch on the center pole pin. A spotter is highly recommended to solely watch the pin and fabric from the outside and make any adjustments necessary to free the caught fabric.



Step 16:

Use the lift to position the bottom of the center pole directly on the mark on the ground that you previously made. As you raise the first center pole the next center pole will lift slightly off the ground from tension of the tent fabric. Be sure as the adjoining center poles begin to raise they do not fall out of the rings.



Step 17:

As the center poles are raised you might need to loosen some of the perimeter web guys to avoid overly straining the top fabric during the installation of the center poles. To release tension on the ratchet depress the gold colored toggle on the top of the ratchet mechanism with your boot or by gently tapping it with a stake.



Step 18:

Once all the center poles are installed you can begin to straighten all of the legs and tensioning all of the ratchet straps. Start with the four (4) corner legs first, make sure they are positioned on the ground mark and then re-tension the web guys so that the leg is plumb. Continue working down both sides of the tent to straighten the legs and tensioning to plumb.



Step 19:
Photo of the fully tensioned Series 2200 Tension Tent.



SERIES 2000 / POLE TENT 40' W x 60' L x 8' LEGS		PART DESCRIPTION		DATE 06/02/06		CHECKED -		SERIES 2000 \SINGLEPOLE\40X60X8	
STANDARD		CODE		DRAWN KT		ENGINEER CM		060206 1440	
REV		SIZE		AZ440608-S2000		490 ALASKA AVE. TORRANCE, CA 90503 (800) 228-3687 - FAX (310) 381-0722		ALL DATA AND INFORMATION CONTAINED IN OR DISCLOSED BY THIS DOCUMENT IS CONFIDENTIAL AND PROPRIETARY INFORMATION OF AZTEC TENTS AND ALL RIGHTS THEREIN ARE EXPRESSLY RESERVED. BY ACCEPTING THIS MATERIAL THE RECIPIENT AGREES THAT THIS MATERIAL AND INFORMATION CONTAINED HEREIN IS HELD IN CONFIDENCE AND IN TRUST AND WILL NOT BE COPIED, REPRODUCED WHOLE OR IN PART, NOR ITS CONTENTS REVEALED IN ANY MANNER TO OTHERS, EXCEPT TO MEET THE SPECIFIC PURPOSE FOR WHICH IT WAS DELIVERED.	

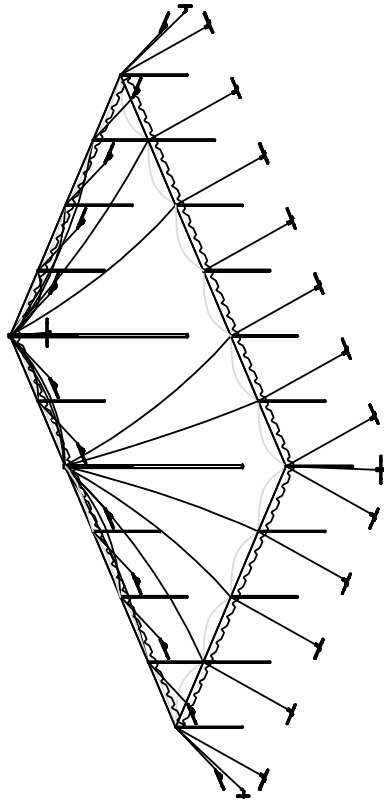

ISOMETRIC ELEVATION

SERIES 2000 TENT
40' x 60' x 8'

- (2) 40' x 20' ENDS
- (1) 40' x 20' MIDDLE
- (2) CENTER POLE
- (20) SIDE POLE
- (28) WEB WINCH
- (28) STAKE BARS
- (84) STAKES

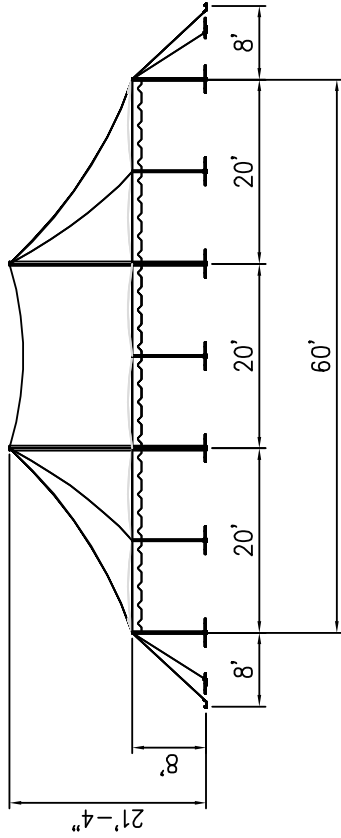

SIDE ELEVATION

● = CENTER POLES NOT TO SCALE

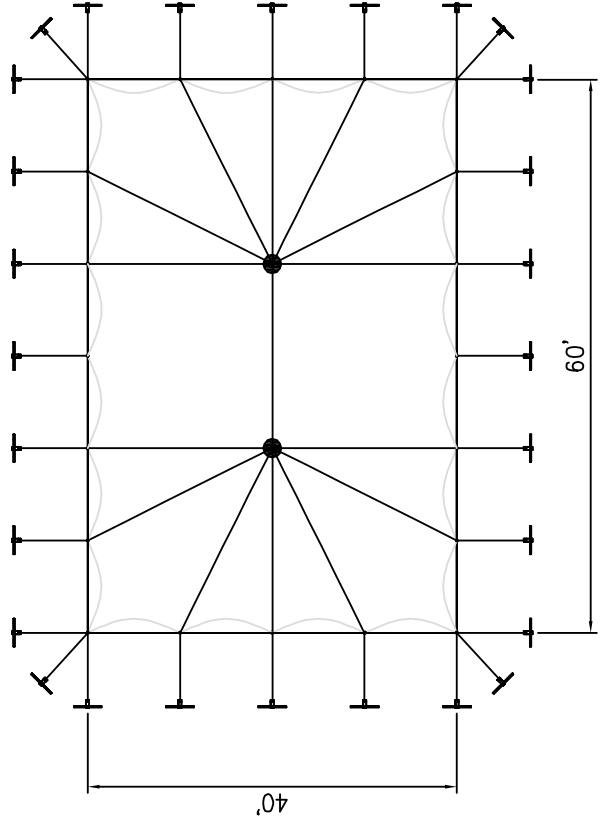

PLAN ELEVATION

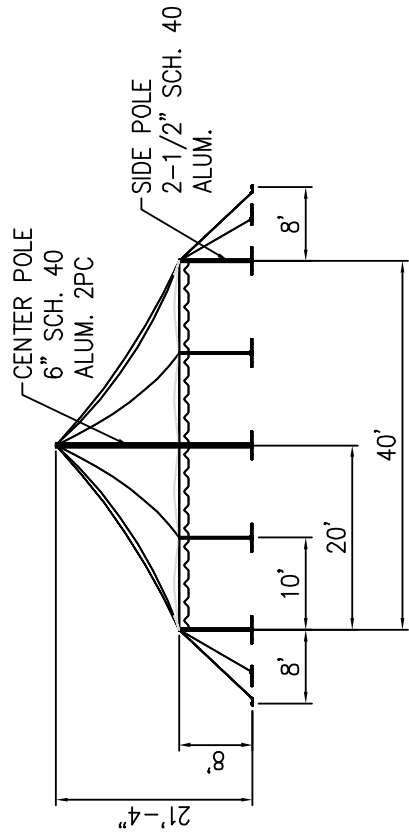

FRONT ELEVATION

REV		DRAWING NUMBER		DRAWING		DATE		CHECKED		050109 1640		POLE TENT\SERIES 2200\60x120	
S2200		AZ60120-SERIES 2200 0		KT		05/01/09		CM		-		POLYESTER	
PART DESCRIPTION				ENGINEER				DRAWN					
POLE TENT / STANDARD				2665 COLUMBIA ST. TORRANCE, CA 90503				AZTEC					
SIZE				228-5687 - FAX (310) 381-0722				60' W x 120' L x 30' MIDDLES					
CODE				665 COLUMBIA ST. TORRANCE, CA 90503				60' W x 120' L x 30' MIDDLES					
DESCRIPTION				228-5687 - FAX (310) 381-0722				60' W x 120' L x 30' MIDDLES					
SERIES 2200				AZTEC				60' W x 120' L x 30' MIDDLES					

ALL DATA AND INFORMATION CONTAINED IN OR DISCLOSED BY THIS DOCUMENT IS CONFIDENTIAL AND PROPRIETARY INFORMATION OF AZTEC TENTS AND ALL RIGHTS THEREIN ARE EXPRESSLY RESERVED. BY ACCEPTING THIS MATERIAL THE RECIPIENT AGREES THAT THIS MATERIAL AND INFORMATION CONTAINED HEREIN IS HELD IN CONFIDENCE AND IN TRUST AND WILL NOT BE COPIED, REPRODUCED WHOLE OR IN PART, NOR ITS CONTENTS REVEALED IN ANY MANNER TO OTHERS, EXCEPT TO MEET THE SPECIFIC PURPOSE FOR WHICH IT WAS DELIVERED.

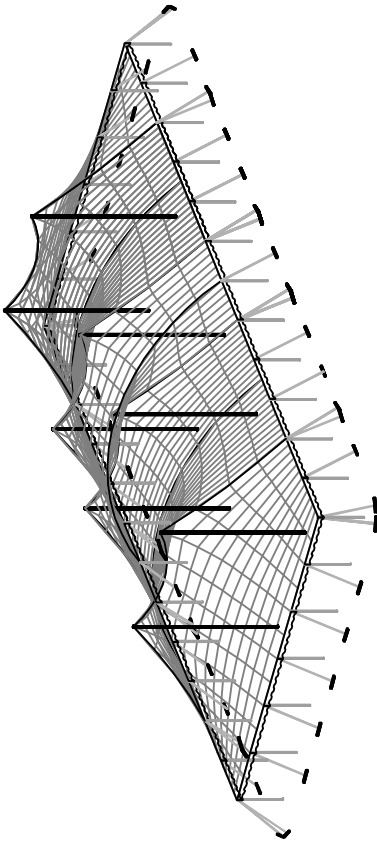

ISOMETRIC ELEVATION

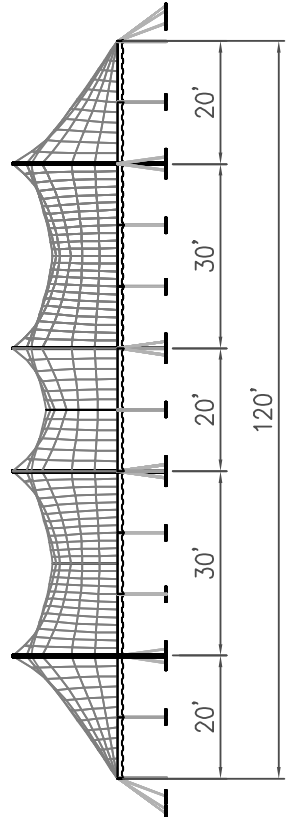

SIDE ELEVATION

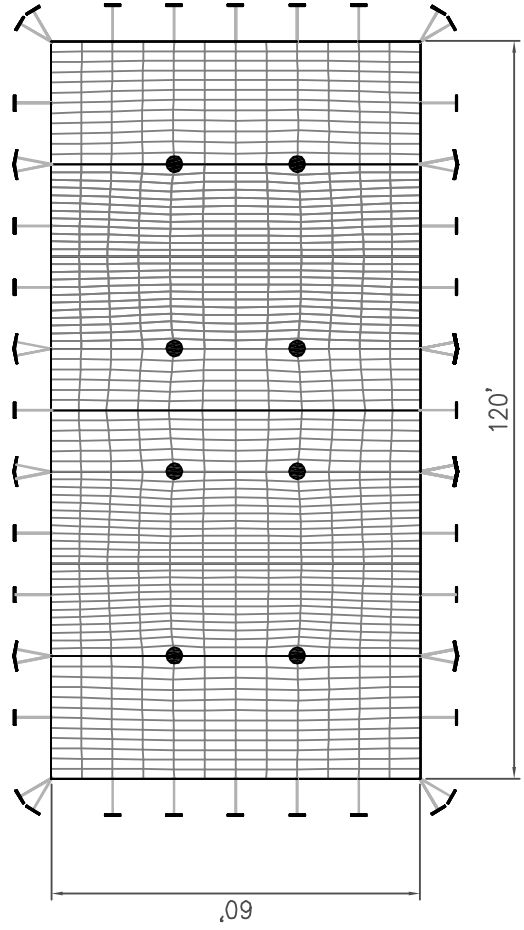

PLAN ELEVATION

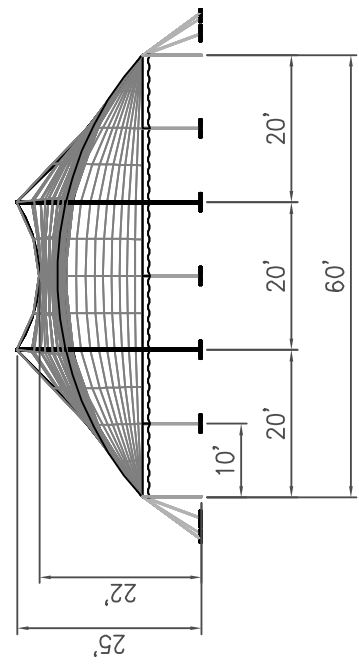

FRONT ELEVATION

SERIES 2200
60' x 120'

- (2) 60'x20' ENDS, 2PC.
- (1) 60'x20' MIDDLE
- (2) 60'x30' MIDDLE
- (8) 4" SCH.40 2PC. CENTER POLE
- (36) 2" SCH.40 SIDE POLE
- (48) STAKES BARS
- (48) WEB WINCH
- (144) STAKES

● = CENTER POLES NOT TO SCALE

SERIES 2200 / POLE TENT 80' W x 120' L x 20' / 30' MIDDLE		PART DESCRIPTION		CODE	SIZE	DRAWING NUMBER	REV
AZ-80120-S2200		KT		CM	KT	020609	1
AZ-80120-S2200		KT		CM	KT	020609	1

ALL DATA AND INFORMATION CONTAINED IN OR DISCLOSED BY THIS DOCUMENT IS CONFIDENTIAL AND PROPRIETARY INFORMATION OF AZTEC TENTS AND ALL RIGHTS THEREIN ARE EXPRESSLY RESERVED. BY ACCEPTING THIS MATERIAL THE RECIPIENT AGREES THAT THIS MATERIAL AND INFORMATION CONTAINED HEREIN IS HELD IN CONFIDENCE AND IN TRUST AND WILL NOT BE COPIED, REPRODUCED WHOLE OR IN PART, NOR ITS CONTENTS REVEALED IN ANY MANNER TO OTHERS, EXCEPT TO MEET THE SPECIFIC PURPOSE FOR WHICH IT WAS DELIVERED.

ENGINEER: CM
 CHECKED: -
 DATE: 020609

2655 COLUMBIA ST. TORRANCE, CA 90503
 (800) 228-3687 - FAX (310) 381-0722
 AZTEC

SERIES 2200\80x120
 022509 1355

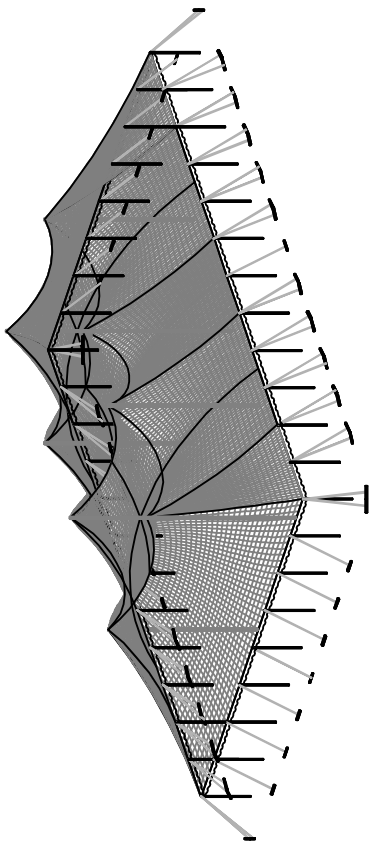

ISOMETRIC ELEVATION

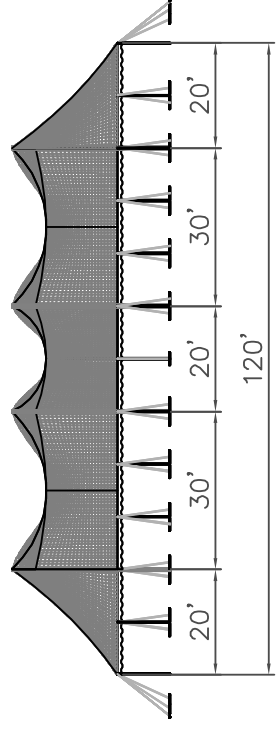

SIDE ELEVATION

SERIES 2200 TENT
 80' x 120'

- (1) 80' x 40' 2PC. ENDS
- (1) 80' x 20' MIDDLE
- (2) 80' x 30' MIDDLE
- (8) 6" SCH 40 ALUM. CENTER POLE (7'L 27' / 8'L 28' / 10'L 30')
- (40) 2" / 2-1/2" SCH 40 ALUM. SIDE POLE (7'L / 8'L / 10'L)
- (66) WEB WINCH
- (66) STAKE BARS
- (198) 1" x 42" DOUBLE HEADED STAKES

DETAIL OF STAKE BAR ASSEMBLY

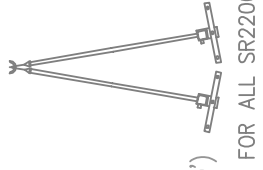
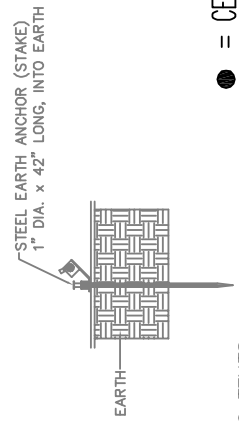

● = CENTER POLES NOT TO SCALE

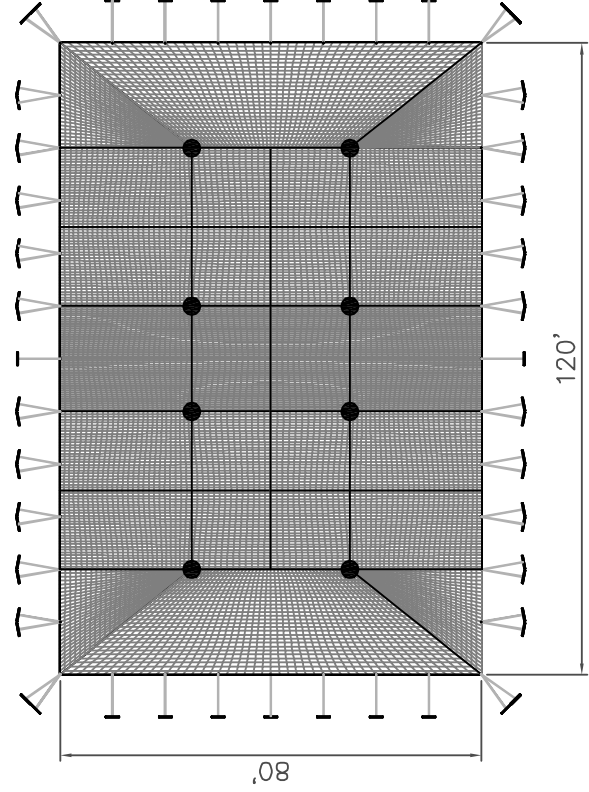

PLAN ELEVATION

6" SCH.40 ALUM. 2PC. CENTERPOLE

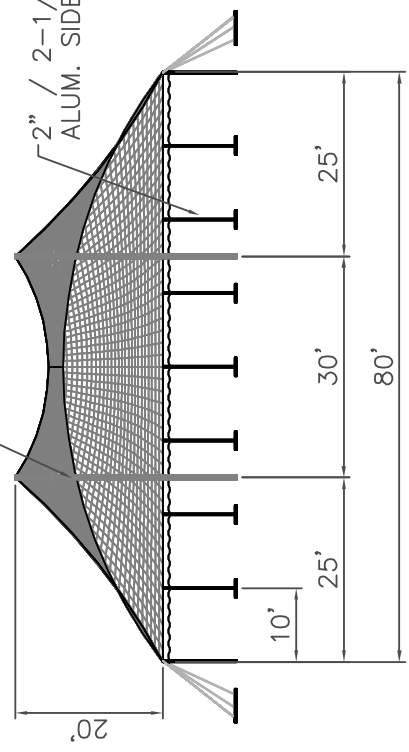

FRONT ELEVATION

If YOU can IMAGINE it... WE can BUILD it

www.aztectents.com

Aztec Tents

2665 Columbia Street
Torrance, CA 90503
Toll Free (800) 228-3687
Fax (310) 381-0722