

PRODUCT MANUAL



If YOU can IMAGINE it... WE can BUILD it

TIMBERTRAC™ COLLECTION

WARNING

This tent product is not intended to be used as a shelter from severe weather. Evacuate immediately if threatening weather occurs (or is forecasted) or any condition arises concerning the safe use of this product. Threatening weather includes electrical storm systems, moderate to high wind (excess of 38mph), heavy rains, snow, or any condition that raises any doubt to the structural integrity of the tent

CAUTION

The installation of electrical, plumbing, lighting, appliances and/or HVAC equipment are not covered within this manual. Users/Installers shall follow local code requirements for the installation of these items using certified personnel. AztecTents shall be indemnified and held harmless from any such use or injury resulting from its use.

Important Safety Information

Proper personnel safety equipment should be worn at all times during the installation of any tenting products.

Hard Hat

Safety Glasses

Hearing Protection

Work Gloves

Long Pants

Steel Toe Boots

OSHA Approved Harness and restraint system (for off ground activities)



Thank you for your recent purchase from Aztec Tents. The following procedures will help you through your installation. If you ever run into problems with the installation of your Aztec Tent give one of our sales/service professionals a call. Other product specific information, contact information, diagrams, and other operational support is available on our web site at www.aztectent.com.

Contents

General Care & Guidelines	
General Fabric Care & Maintenance	4
Special Care For Unsupported Clear Fabric	5
General Hardware Care & Maintenance	5
Pre-Installation Guidelines	6
General Installation Guidelines	6
Post Installation Guidelines- Maintenance	6
Safety & Evacuation Planning	7
General Take Down/Removal Guidelines	7
Anchoring	7
Anchoring Tie-downs	8
Flame Retardant Fabric	8
Other Resources	8
Tools Required for Installation	8
Optional Items & Accessories Available	8
Installation Procedure	9-14
Timbertrac Squaring	15
Timbertrac 20x (6m) Arch Profiles	16
Timbertrac 30x (9m) Arch Profiles	17
Timbertrac 40x (12m) Arch Profiles	18
Timbertrac 50x (15m) Arch Profiles	19
Timbertrac Portal Brace	20
Timbertrac Bolt Diagram	20
Parts Images	21-24
Engineering Specifications	25-26
Timbertrac Component Listing	27

Questions? Call us.

Aztec Tents

2665 Columbia Street
Torrance, CA 90503 USA
Direct (310) 347-3010
Toll Free (800) 228-3687
Fax (310) 381-0722

V.072423

General Fabric Care & Maintenance

The vinyl fabric developed for this tent system requires specific attention during installation, cleaning, and storage to maintain its maximum life span. Please follow the following care and maintenance guidelines provided for this product.

GROUND CLOTHS:The usage of ground covering material under the tent during installation and dismantle will protect the tent fabric from soiling and from minor surface abrasions. A ground cloth can also help keep the tent top dry if the ground surface (i.e. dirt, grass, etc.) is wet during the installation or dismantle.

MILDEW TREATMENT:The fabric is pretreated with mildew inhibitors that help prevent the growth and spreading of mildew and fungus. Although treated, proper care should be given to prevent potential growth. If you see mildew wipe it away immediately with a clean towel and diluted soap solution. Never fold your fabric for storage if the fabric is even slightly wet. Mold/Mildew spores in the air and on the ground will come in contact with the fabric while installed. To grow, all the mildew needs is moisture and some source of food (often found in dirt that might be on the tent). Your best bet is to keep your fabric clean and dry to prevent mildew growth.

FABRIC CLEANING:The best way to clean the vinyl tent fabric is with a soft towel or soft bristled brush immersed in a diluted solution of warm water and our tent cleaning solution. A diluted and mixed solution of a tablespoon of traditional dish soap with a gallon of warm water will also work, but extra caution should be placed on insuring that this cleaning solution is thoroughly rinsed from the fabric especially with clear vinyls (See special notes on working with clear vinyls).

You will need a large, smooth, flat space slightly larger than the section of fabric. This space should be covered with a ground protecting layer to avoid damaging the tent membrane when moving in the washing area. Small impediments, sharp objects and rough surfaces all have the potential to damage the membrane you are trying to clean.

Follow the instructions for the proper dilution ratio of your cleaning product. Apply the diluted solution directly to the fabric using 1) a towel immersed in the solution, or 2) a spray bottle or larger pressurized spraying apparatus to evenly cover the fabric with the solution. Let this sit on the fabric for about one minute to allow the mixture to penetrate the fabric. Using a soft towel or soft bristled polypropylene brush (some can be mounted to a long handle to allow you to stand while working), gently work the cleaner into the fabric using only mild pressure. While harder bristled brushes can work, they will end up microscopically scratching the fabric, potentially permanently damaging the fabric and making it harder to clean the next time. The process of hand cleaning the fabric will allow you to apply only enough diluted solution to get the fabric clean. This will help limit the amount of water placed on the fabric to expedite drying time. Never allow the tent cleaner to dry on the fabric. For this reason, larger tents might be better to clean in sections. Once the cleaning is complete be sure to rinse away any cleaning solution completely from the tent membrane.

Full immersion of the fabric in water is not recommended. The use of commercial front loading or top loading washing machines is not recommended and will void the warranty of the fabric. These machines cause an excessive amount of stress to the fabric and can force water into the fabric causing increased occurrences of mildew growth and shorten the life of the fabric. As with any cleaning, the fabric should be hung to dry completely before folding and storage. Cleaners that include chlorine bleach, and/or any petroleum based solvents will degrade the fabric, discolor the fabric and shorten its life span.

If you have a difficult stain that cannot be removed with traditional cleaning, please consult with your sales person before trying any other chemicals that might end up damaging the material further. Do not use other chemicals or cleaners unless instructed by your sales professional.

FABRIC DRYING:The best way to dry the vinyl tent fabric is to hang-dry in a low humidity environment. Circulating air around the surface of the hanging fabric with the use of fans will also speed the drying process and improve drying time in more humid environments. Please also assure that subassemblies and other components within the tent system are dry before folding. These subassemblies can be reinforcements, lace lines, webbing, rope, thread, and/or any other part that is permanently affixed to the main tent membrane. The use of commercial drying equipment and any drying using heat will void the warranty of the fabric. **DO NOT STORE YOUR FABRIC WET.** Fabric folded and stored wet will mildew.

TENSIONING: Do not over tension your tent fabric during installation, use, or removal. Over tensioning can cause permanent damage to the tent membrane. The most obvious sign of over tensioning would be stress wrinkles at the tension points. Be sure to confirm that your frame/pole components match the tent design. In cases where the ground is not level, over tensioning is possible by trying to force the tent to dimension.

STORAGE RECOMMENDATIONS:The fabric for the tent system shall be stored dry in a cool, dry place in the protective storage bags included with your purchase. Other types of bags are acceptable as long as they can protect the fabric from the environmental elements of the storage area. Optimal storage temperature is between 50°F (10°C) and 70°F (21°C).

INSPECTION: Prior to each use, each component of the tent system needs to be thoroughly inspected to assure its structural stability has not been compromised. Fabric components that are ripped, torn, frayed, or damaged shall be immediately replaced and not used. Structural components of the fabric membrane are the most critical including but not limited to the main fabric membrane, structural reinforcements and webbing, web termination plates/rings/fasteners, and connection points from fabric panel to fabric panel or connection points between the fabric panel and the hardware support system.

Special Care For Unsupported Clear Fabric

The clear fabric used in window style sidewalls, clear sidewalls, and clear tent tops needs to be managed differently than standard tent fabric. Polyester scrim is what gives standard tent fabric its strength, stability and durability. Laminated tent fabric enjoys the benefit of encasing this woven layer of rip-stop polyester between the layers of colored vinyl film. Clear vinyl does not enjoy those benefits. Because of this, clear vinyl has a very low tolerance to ultra violet ray exposure, wind, airborne particulate matter, hot or cold temperatures, elasticity due to wind and rain and handling. Any or all of these factors will cause clear fabric to under perform when compared to traditional tent fabric.

Exposure to ultra violet rays for an extended amount of time as will occur with time over the life of the product, will cause the fabric to appear milky or opaque. Putting away and storing damp or wet clear vinyl will result in a foggy hue in the clear film. Usually, this fogginess will disappear when the walls are left open to dry and warm up. Steady wind can whip clear vinyl back and forth and cause surface or through cracks in the fabric. Heat in excess of 85°F (29°C) will cause clear vinyl to stretch and distort. Although our clear vinyl has a cold crack rating of near freezing, that rating is for a static environment. Any introduction of wind or manipulation by handling will cause failure (cracking like glass) in colder conditions. Use of clear fabric in temperatures less than 50°F (10°C) should be avoided. Airborne particulate matter will abrade the surface and cause the finish to become less translucent.

Clear tent tops are also very susceptible to water ponding as they are highly elastic. If rain is forecasted during the use of these products it is recommended to take additional precautions and more frequent inspections throughout the duration of the rainfall to inspect for potential ponding on the roof fabric. If rainwater ponding occurs at any point on the fabric, evacuate the tent, remove the water, and adjust the tie back rope/web prestress tension and/or fabric tensioning over the frame back to its design geometry to achieve positive drainage.

Special attention should be paid to the cleaning of these items. Use only the softest towels when cleaning the clear membrane to avoid scratching the highly polished surface, and wipe dry to avoid water spots. Use standard diluted tent cleaning solution. **DO NOT USE OTHER CHEMICALS.** Optimal storage temperature is between 50°F (10°C) and 70°F (21°C).

General Hardware Care & Maintenance

The hardware components developed for this tent system requires specific attention during installation, cleaning, and storage to maintain its maximum life span. Please follow the following care and maintenance guidelines provided for this product.

OXIDATION: The hardware components for this tent system have been supplied to you with specialty coatings to help limit oxidation. With usage, these coatings will need to be maintained in order to limit oxidation and for the product reach its full intended lifespan. With plated or powder coated steel components, any rust should be removed immediately with a stiff wire brush and sprayed with either a galvanizing spray or durable paint to seal the steel from the elements. Anodized aluminum components will get scratched over time and these scratched areas can develop a thin black oxidation common with mill finish aluminum. This black oxidation can cause staining to any fabric components that come in contact with the pole/component. Your best preventative measure will be to avoid scratching of the anodized coating by avoiding any sharp edges that might be come in contact with the aluminum member.

HARDWARE CLEANING: It is very important to keep your hardware components clean and free of dirt, oxidation, and other chemicals especially if those hardware components come into contact with any fabric components during installation, use, or take-down of your product. Any dirt, oxidation, or chemical on the surface of the hardware member can transfer the contaminant to the fabric causing permanent staining, or permanent damage to the fabric membrane. If hardware components are found to be soiled, wipe down immediately to remove the foreign matter.

STORAGE RECOMMENDATIONS: The hardware for the tent system shall be stored dry in a cool, dry place. Anodized aluminum component can be stored outside, but should be covered to prevent foreign matter from collecting on the components that might stain or damage the fabric membrane during installation or use. Any/all steel components shall be stored indoors in a dry/low humidity environment.

INSPECTION: Prior to and after each use, each component of the tent system needs to be thoroughly inspected to assure its structural stability has not been compromised. Hardware components that are bent, cracked, frayed, or damaged shall be immediately replaced and not used. Specific attention should be paid toward any devices used for anchoring including ratchets, ropes, cables, and web straps.

Pre-Installation Guidelines

Correct field installation of this tent system requires diligence and considerable skill and expertise which can be obtained only through the proper field training and experience of a professional rental tent supervised installation crew. This is instrumental to obtaining the optimal structural behavior of the tent.

- Obtain any required permits or inspections needed by local codes and regulations.
- Clear the site to prepare for the planned activity.
- Check for sub grade utilities before installing any anchoring devices.
- Check for any overhead obstructions that might interfere with the tent installation. Do not install any tent within 50' of any overhead utilities, power lines, or other obstructions. Installation under or within close proximity to trees should be avoided.
- Locate the public circulation routes with clearance from anchors around the exterior of the site. Identify clearly.
- Use drop cloths to prevent soiling or damaging the fabric membrane.
- Pad and tape objects with sharp projections which will remain on site under the tent.
- Cover any sharp edges on anchoring devices with protective material

General Installation Guidelines

Each component of the tent should be inspected at the beginning of installation for visual signs of damage by the installer. All damaged materials should be repaired or replaced immediately.

The weather should be carefully considered by the Owner and/or the Installer before raising the tent since the hardware and fabric cannot transmit design wind loads or shed rainwater loads (potential ponding) when it is not fully anchored, installed, and/or tensioned. It is recommended that installation or removal of the fabric members be performed when the wind speed is less than 15 mph. The decision to raise or lower the fabric of the tent should be the responsibility of the experienced rental tent installation supervisor based upon conservative life safety considerations and judgement.

Adequate and appropriate installation and maintenance procedures are necessary to achieve and sustain full design load capability for the tent. The Owner and/or Installer are fully responsible for assuring that the tent is properly installed and maintained.

Certification of this tent structure is valid only with the use of AztecTent supplied and assured components or those which meet or exceed the requirements of the design throughout the installation of this structure, with the exception of the anchoring devices which must be determined by the installation engineer.

Post Installation Guidelines/ Maintenance

Each component of the tent should be inspected at the end of installation for visual signs of damage by the installer. Additionally, an inspection should be performed after any severe weather/wind events that might have affected the overall integrity of the design. All damaged materials should be repaired or replaced immediately.

A variety of material and weather factors can result in fabric stretch, web belt stretch, rope stretch, mast base settling, changes to design geometry, etc. Changes to the design geometry of the tent and consequently the structural performance characteristics of the tent, can occur while the tent is in service and not attended by the professional installer. It is recommended that a maintenance agreement be arranged between the Client/User of the tent and the Installer involving periodic inspections and adjustments.

If rainwater ponding occurs at any point on the fabric, evacuate the tent, remove the water, and adjust the tie back rope/web prestress tension and/or fabric tensioning over the frame back to its design geometry to achieve positive drainage.

It is understood and expected that some damage to the fabric membrane and/or non structural components may occur in conditions below the overall design wind velocity rating of the tent system. This damage may result in components requiring repair or replacement as necessary.

Safety & Evacuation Planning

It is the responsibility of the Owner and/or the Installer to warn the User and or Occupants of the tent system that this product is not intended to be used as a shelter from severe weather. Aztec assumes no liability for such use. An evacuation and communication plan for the area covered within this tented space is imperative and shall be thoroughly communicated to all users and potential occupants of the tent. Severe weather including electrical storm systems, moderate to severe wind, heavy rains, snow, or any condition that raises any doubt to the structural integrity of the tent are immediate signs that an evacuation is necessary. Severe bodily injury and/or death can occur. A best practices document published by the American Rental Association covering this topic can be downloaded at: <https://www.aztectent.com/resources/documents>

Common signs that warrant the immediate evacuation of this tent:

- Any movement, displacement, or failure of any of the anchoring devices or support hardware.
- Any component failure in part or whole
- Any tear or puncture in the fabric membrane
- Any forecasted moderate to severe weather condition
- Any collection or accumulation of snow or ice on the tent
- Strong winds causing movement and/shifting of the tent or tent support structure
- Strong winds causing small branches to be ripped from trees
- Any lightning or electrical storms
- Hail or frozen precipitation any larger than pea size
- Any fire or smoke within close proximity of the tent
- Any small of gas, exhaust, or other odor from any combustible material

In the event of forecasted severe weather, hurricane, or other such early warning, it is recommended to immediately evacuate the tent and time permitting take down the tent and remove from the site.

General Take Down/ Removal Guidelines

The weather should be carefully considered by the Owner and/or the Installer before lowering the tent since the hardware and fabric cannot transmit design wind loads or shed rainwater loads (potential ponding) when it is not fully anchored, installed, and/or tensioned. It is recommended that installation or removal of the fabric members be informed when the wind speed is less than 15 mph. The decision to raise or lower the fabric of the tent should be the responsibility of the experienced rental tent installation supervisor based upon conservative life safety considerations and judgement.

Unless otherwise noted in the procedures that follow, the removal of this tent system shall follow the same procedures outlined but in the reverse order.

Once unassembled, each component of the system should be inspected for any signs of visual damage by the installer. All damaged materials should be marked or identified so that repair or replacement of these materials can occur prior to the next use of the product.

Anchoring

All anchoring locations must be laid out accurately as described in the manual and diagrams contained within (in advance of laying out the fabric) to a tolerance of +/- 4" in any direction (right or left, forward or back, up or down, etc.) All column base locations must be laid out to a tolerance of +/- 3" in any direction for any standard supported tents and within a tolerance of +/- .5" for any product utilizing keder channels.

A wide variety of ground anchoring devices are commonly used. Soil conditions and resulting ground anchor holding capacities vary from site to site, and can vary within a particular site. The Owner and/or Installer of the tent is fully responsible for assuring that the selection and installation of the anchoring devices is adequate to resist the pull out loads specified in the product manual.

Reduced anchor performance can occur under wet soil conditions and needs to be accounted for. Care should be taken that water is not allowed to drain or collect near anchors. Anchoring device holding capacity can be developed using a single large device, or by using multiple smaller devices. Ensure that the anchors installed are adequate to resist the pull out loads shown. Actual testing of some individual anchors to 75% of the anchor pull-out load is recommended.

Additional installation and anchoring information entitled "The Procedural Handbook For The Safe Installation And Maintenance Of Tentage" is published by the Tent Rental Division of the Advanced Textiles Association (ATA).

Anchoring Tie-downs

Although we use high quality thread and webbing for all of our sewn tie-down components, ultraviolet light from the sun will slowly breakdown these fibers over time. Chemicals, cleaners, or other products should not be used on webbing tie-down components as its use might accelerate this aging process. Damaged, abraded, cut, or frayed straps should never be used. Additionally, these straps should never be used for other tie-down applications other than securing the tent for which they were purchased (i.e. securing equipment on a pallet, truck, or trailer). Seasonal installations should replace tie-down straps annually or sooner if any damage is noted. Other straps used in short term applications should be tested periodically to assure that they meet the intended working load for their design. Straps shall expire 5 years from the date of their manufacture (noted on the item tag) and shall not be used.

Flame Retardant Fabric

All vinyl fabric used in the production of our tents, walls, and accessories are made with flame retardant fabrics. These fabrics have been tested and passed one or more of the following flame retardancy standards: California State Fire Marshal (Code of Regulations Title 19 Section 1237.1), NFPA 701 (Test method 2), Canadian CAN-ULC-S109-03, British Standard BS 7837:1996 (2015), and European M2. These vinyl products are produced so that they are inherently flame retardant, and thus will never require additional applications of flame retardant chemicals. Every section of fabric produced by AztecTents contains a label identifying its flame resistance characteristics and date produced. This label matches a hard copy of the flame certificate that is mailed to you after receipt of your goods. If at any time you need to be issued a duplicate flame certificate, you can request one from our customer service representatives. Please be sure to have the invoice number and date of production available when requesting duplicate flame certificates.

Other Resources

American Rental Association- www.ararental.org

Tent Rental Division of The Advanced Textiles Association- <https://tent.textiles.org/>

Tools Required for Installation

Sledge Hammer	For driving anchoring stakes
Purlin Fork	For purlin installation when tilting beams up
Drop Cloths	For protecting fabric membrane
Pull Ropes	For pulling fabric membrane over roof
8' Ladder	General installation tool
Utility Knife	General installation tool
Tape Measure	General installation tool
Marking Paint/Chalk	Used to mark anchoring locations and tent boundaries
Powered Drill	Note: Impact tools not recommended as they can overtighten bolts and damage coating. Use only tools with adjustable clutch settings set to lowest setting possible to tighten nut . DO NOT OVERTIGHTEN
Wrenches/Sockets	See Sizing Requirements below Beam Assembly Bolts 3/8" Diam- Requires 9/16" Socket/Wrench Portal Brace Bolts 1/2" Diam- Requires 3/4" Socket/Wrench Extended Eave Tensioners 3/4' Diam- Requires 1-1/8" Socket/Wrench

Optional Items & Accessories Available

JT Keder Feeder Set	Assists in feeding membrane panels into the keder track beams
Side Wall Panels	To enclose walls of tent
Canopy Doors	To add easily accessible means of egress to and from the tent
JT Wall Tension Bars	To secure the bottoms of the walls from moving in breezy conditions
Additional Anchors	Additional anchors used to secure the tent system

Installation Procedure

Step 1:

Mark all the baseplate locations with paint or chalk by using the $a^2+b^2=c^2$ method or squaring diagram. A squaring diagram for your size tent can be provided by contacting Aztec Tents. Secure each baseplate to the ground with 42" (106 cm) stakes. Also install the stakes for the guy lines at this time. Drive anchor stakes straight through the ring on the in-line ratchet assembly and into the ground at a distance equal to the leg height of the tent from the baseplate. Drive the 42" stakes so all but 2" (5cm) is embedded.

NOTICE

The anchoring devices included with the purchase of this tent will not be suitable for every application or ground condition. It is the installers responsibility to confirm that the anchoring devices used will support the recommended resistance load requirements specified in the appendix of this manual. Additional or different types of anchors may be needed depending on ground conditions.

Step 2:

Lay out frame parts of the tent in place so they are easy to install. See the specific diagram for your size of tent in the pages following the instructions. Your first two arches should be facing opposite directions in order to help when tilting up the initial bay.

Step 3:

Assemble the gable arches. Start by connecting the leg to the baseplate and Side "T". For 50' (15m) wide (with 2 piece rafters) units, assemble the two piece rafter and then proceed as described. Next, install the JT3 Rafter to the eave on one end and the crown fitting on the other. Follow with the other rafter, eave fitting and leg. Connect wall cables to the gable corner fittings and roof cables to the gable end crown. Repeat this process for the interior arches. Cabling will be done on both end bays as well as every 60' (18m) on the interior.

NOTE: Setting the fittings and beams on 4"-6" (10-15cm) blocks during installation will help with access to the bolts/nuts on the underside of the beams.

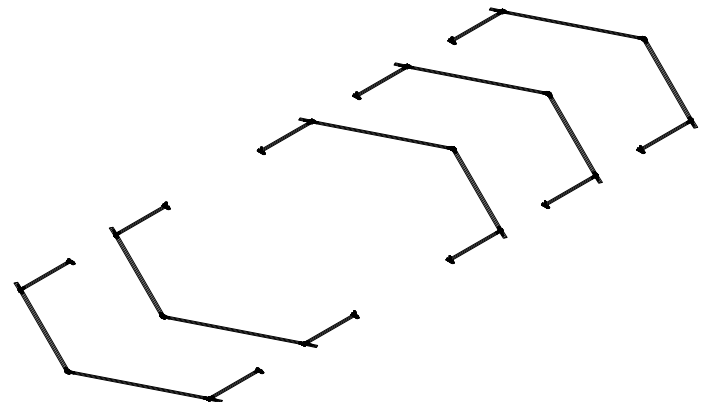
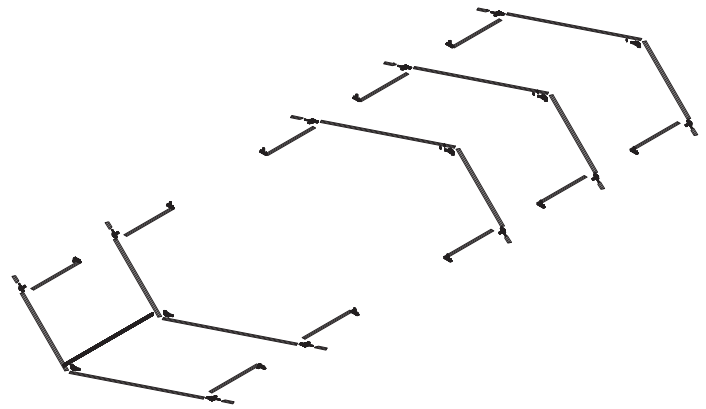
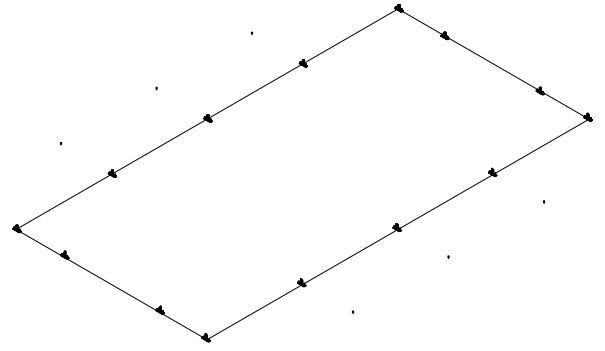

Step 4:

Assemble the truss portion of each arch. See diagrams for your tent size in the pages following for proper pipe lengths and plate locations. All Timbertrac plates are held on with nuts and bolts (See bolt diagram on page 20 for correct bolt configurations). You can also install the purlin (if needed for your size) and eave plates as this time.

**Use of an impact drill may cause damage to the graincoat finish.

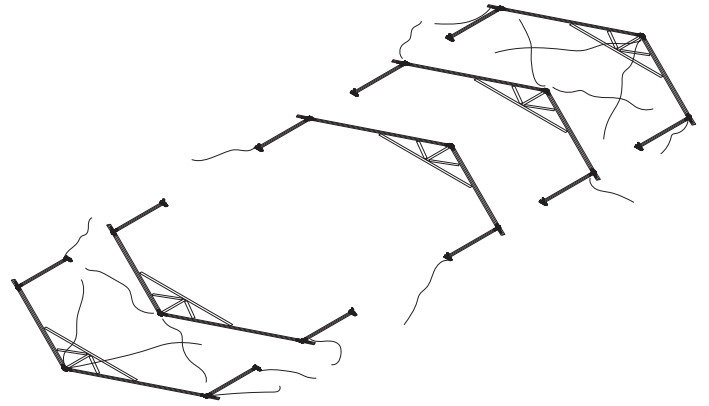

Step 5

Connect the swivel end of the ridge and eave purlins to the arch. Connect the install straps around the stakes of the adjoining arches baseplate. Begin tilting up beams by starting with the second arch. You can use the ridge purlin to help push the beam vertical or for 40x (12m) & 50x (15m) tents, a ridge extender can be used to assist with this step. Once vertical, connect the install straps from the first beam baseplate to the eave fitting of the second beam and from this same eave fitting down to the third baseplate along the length to brace the beam in position. Install and pin the eave purlins into the side "T" fittings. Connect the shackles to the baseplates to secure the leg into location.

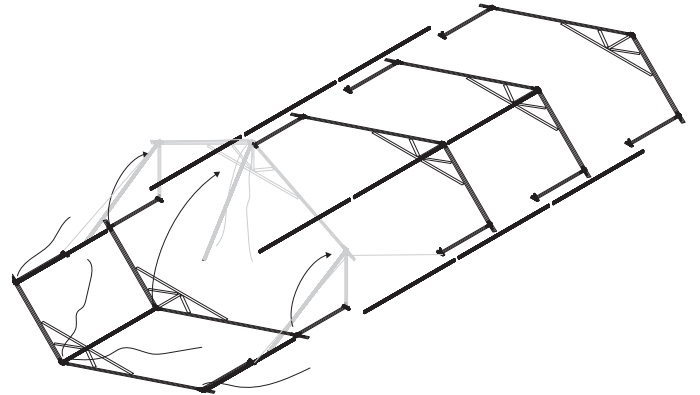

Step 6:

Push up the gable beam arch and use the purlin tool to raise the ridge purlin from the second arch and connect it into the gable end fitting. Lift, connect and pin the eave purlins into the gable corner fittings.

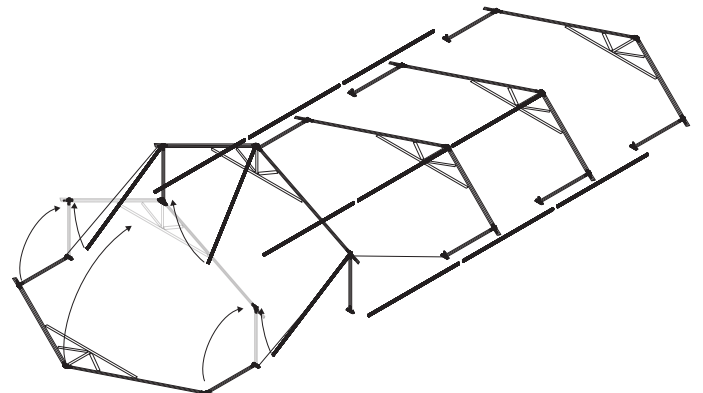

Step 7:

Install and secure roof and wall cables on gable bay. These cables will be tightened after the fabric is pulled on. Build subsequent mid section framing. Connect eave purlins for the next bay and pin into location. The ridge purlin should be pinned in on the ground and is used to help push up the beam. Continue to tilt up remaining arches and connect purlins as you go.

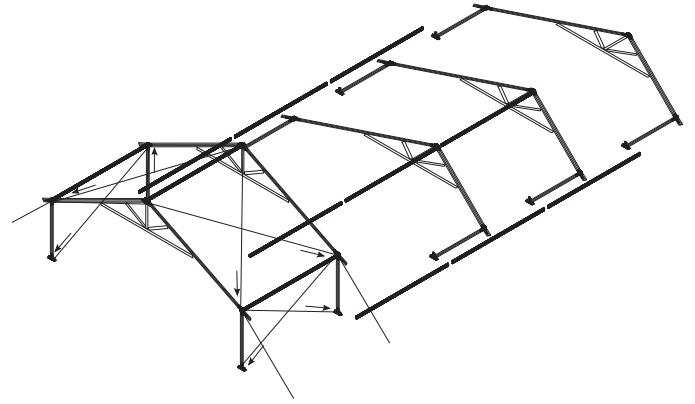

Step 8:

Tilt up remaining beam arches and connect roof and wall cables.

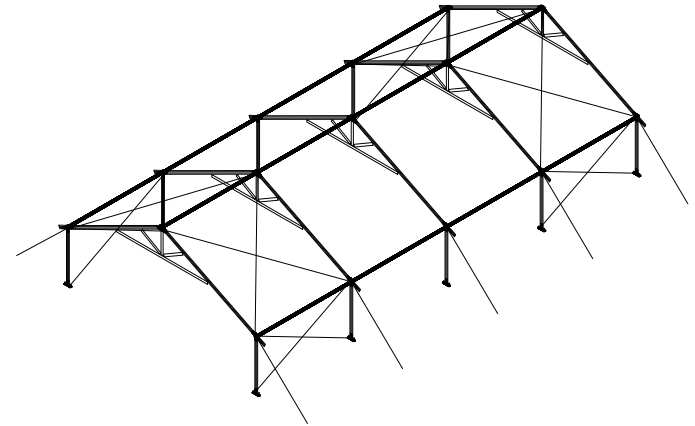

Step 9:

Install gable eaves, risers and baseplates if desired. This hardware is required if using a gable end and/or sidewall. When using the gable end hardware, 42" (106cm) stakes are provided to secure the baseplates.

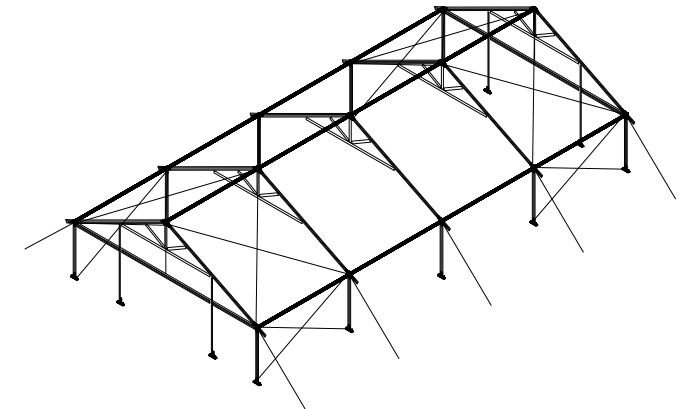

Step 10:
(This step is only used for frame designs with extended eave option)
Install the rafter extension beams with extended eave tensioner into the side tees and gable corners.

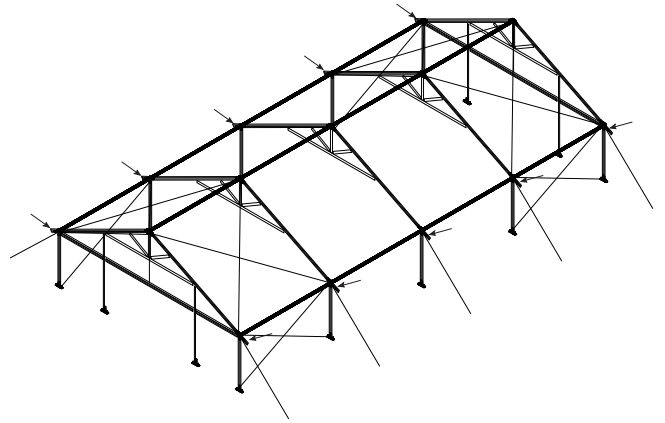

Step 11:
Tighten guy ratchets to the guy out stakes.

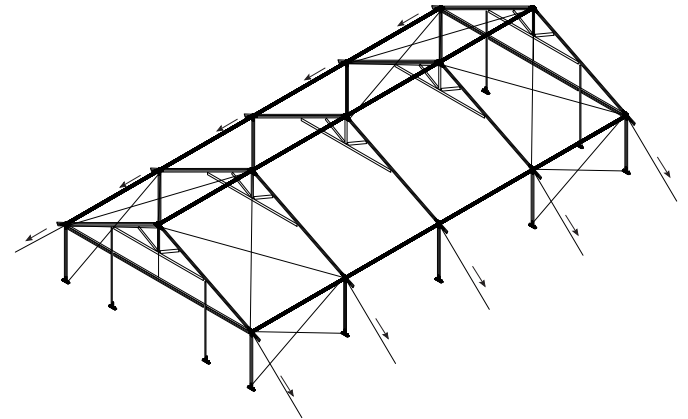

Step 12:
Install gable end panels. Lay out ground cloths under the area to open the tent fabric. Each gable is split into a "Left" and "Right" half that will slide into the tracks of the rafter beam extension (connected to the gable corner) and slide upward to the crown. Pull each half of the gable together and connect them using the hook and loop, velcro style closure to adjoin the two sections. Repeat this process for the other gable end panel.

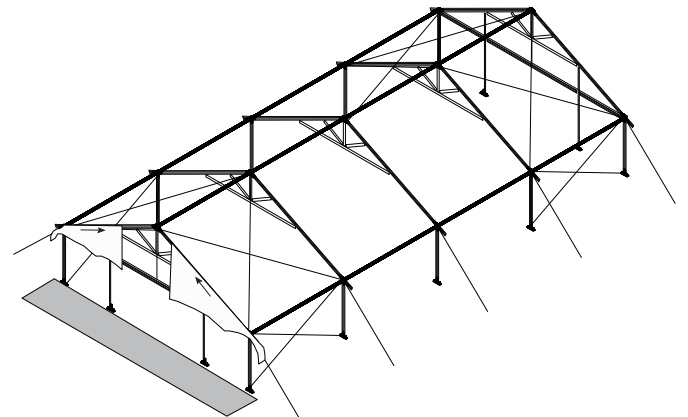

Step 13:

Install middle fabric panels. Lay out ground cloths under the area to open the tent fabric. Throw two ropes over the mid frame and connect them to the web strap on the end of the panel (do not connect pull ropes to metal D-Rings). With the glossy side of the fabric facing upward (the flame certificate information should be inside of the tent when finished), start feeding the ends of the panel into the tracks mounted on the rafter extension beam. Once the panel is started, the pull ropes can be pulled evenly to pull the fabric up and over the frame. You should have installers feeding the fabric as the others pull. Continue this process for all the middle panels.

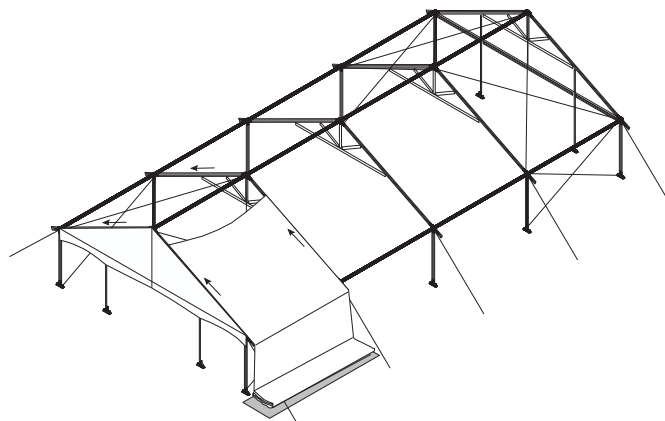

Step 14:

Tighten wall and roof cables at each end bay and middle bays (if necessary). If your Timbertrac includes portal braces, now would be the time to build those and install in place of the leg cables. Remove cables and replace with portal braces one bay at a time. Note: Roof and wall cables or portal braces are required on each end bay and shall also be added after 60' (18m) of continuous non-cabled bays.

**Do not mix portal braces and wall cables on the same frame. It is recommended to use one or the other due to the way they operate.

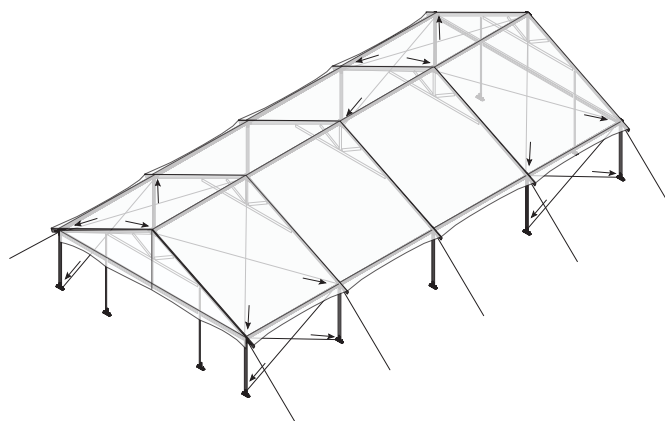

Step 15:

Tension the tent top. At each leg you will need to apply tension on the valance rope tensioning system down to the hole in the midpoint of each leg upright. Each tent top section ends with a 2" D-Ring and a 1/4" braided rope with an O-Ring that extends out from the valance hem. The O-Ring on the end of this rope must be passed through the D-Ring on the adjacent fabric section and then down toward the ground. Use the included 1" tensioning ratchets to "hook" both of the O-Rings of the adjoining sections and tension toward the hole at the midpoint of each leg column. If you have the extended eave version, you will also need to take the D-Ring at the corner of the extended eave valance and hook it onto the Timbertrac Tensioner. Tightening the bolt on end of the extended rafter will apply tension to the extended valance. This is a 3/4" Diameter bolt requiring a socket or wrench measuring 1-1/8".

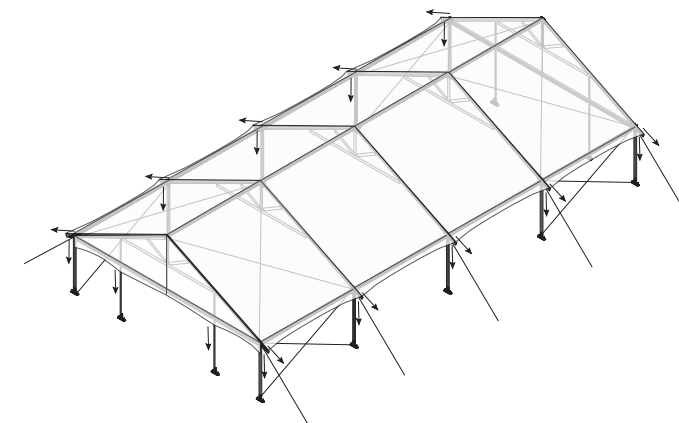

Step 16:
Install the Midspan Tensioners around the eave of the tent for all roof panels. The mid span tensioner is placed over the eave at the midpoint between two legs and connected to the strap that is permanently affixed to the roof panel.

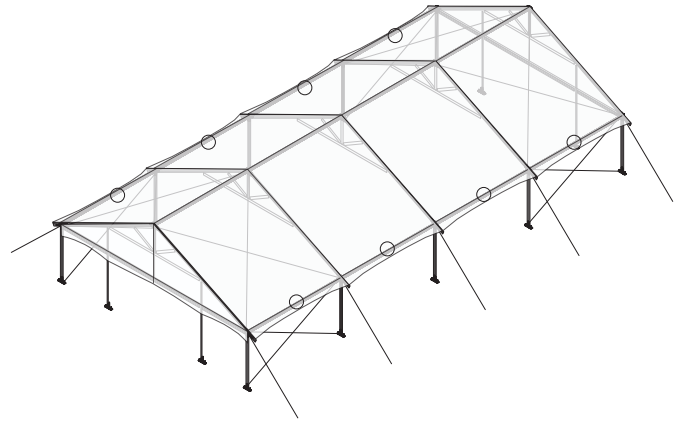

Step 17:
Install the sidewall panels if desired.

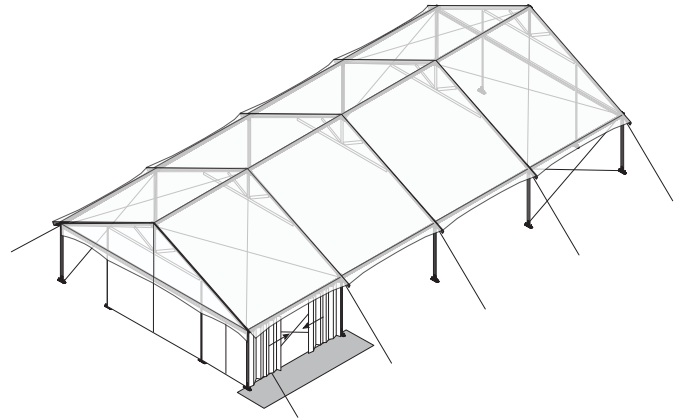

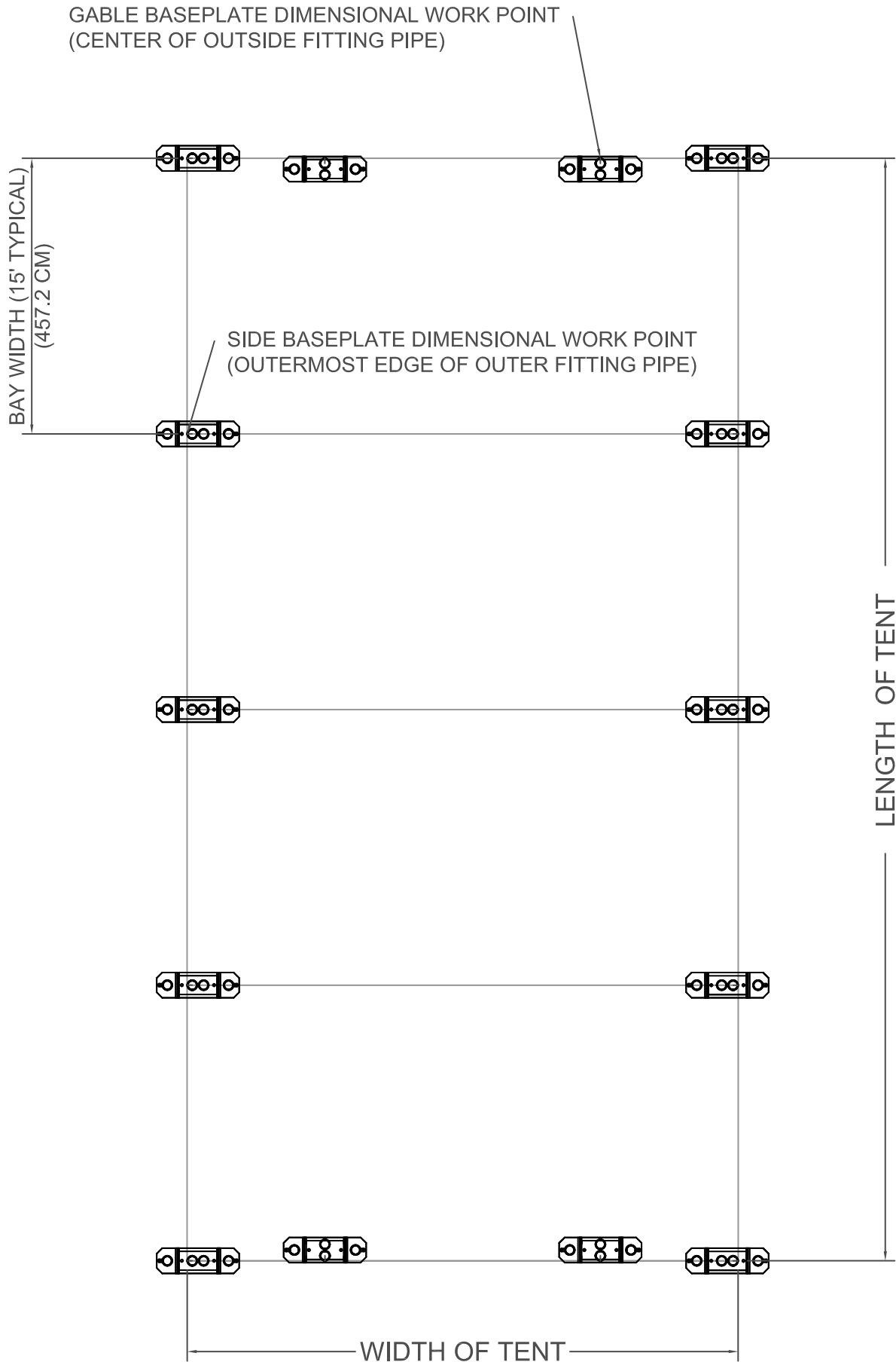

Timbertrac™ 20x (6m) Gable End Profile

ITEM	QUANTITY	DESCRIPTION	PART #
1	1	TIMBERTRAC GABLE CROWN	Z291F00010
2	2	TIMBERTRAC GABLE CORNER (L/R)	Z291F00026/Z291F00027
3	2	TIMBERTRAC TILT-UP BASE PLATE	Z291F00045
4	4	TIMBERTRAC EAVE PLATE- STEEL	Z291F00212
5	2	TIMBERTRAC CROWN PLATE- STEEL	Z291F00215
6	4	TIMBERTRAC TRUSS PLATE LOWER- STEEL	Z291F00220
7	4	TIMBERTRAC TRUSS PLATE UPPER- STEEL	Z291F00225
8	2	TIMBERTRAC TRUSS PLATE CENTER- STEEL	Z291F00230
9	2	TIMBERTRAC (JTS) 7"-8" LEG	Z291J130708
10	2	TIMBERTRAC (JTS) 10"-8"	Z291J131006
11	1	TIMBERTRAC 20' GABLE FURLIN- 20x	Z291JTR20000.20
12	1	TIMBERTRAC TRUSS- J (20x) 18-3/16"	Z291JTR20018.19
13	2	TIMBERTRAC TRUSS- J (20x) 20-1/4"	Z291JTR20020.25
14	1	TIMBERTRAC TRUSS- J (20x) 107"	Z291JTR20107.00

20'W (609.6CM) GABLE END TIMBERTRAC PROFILE

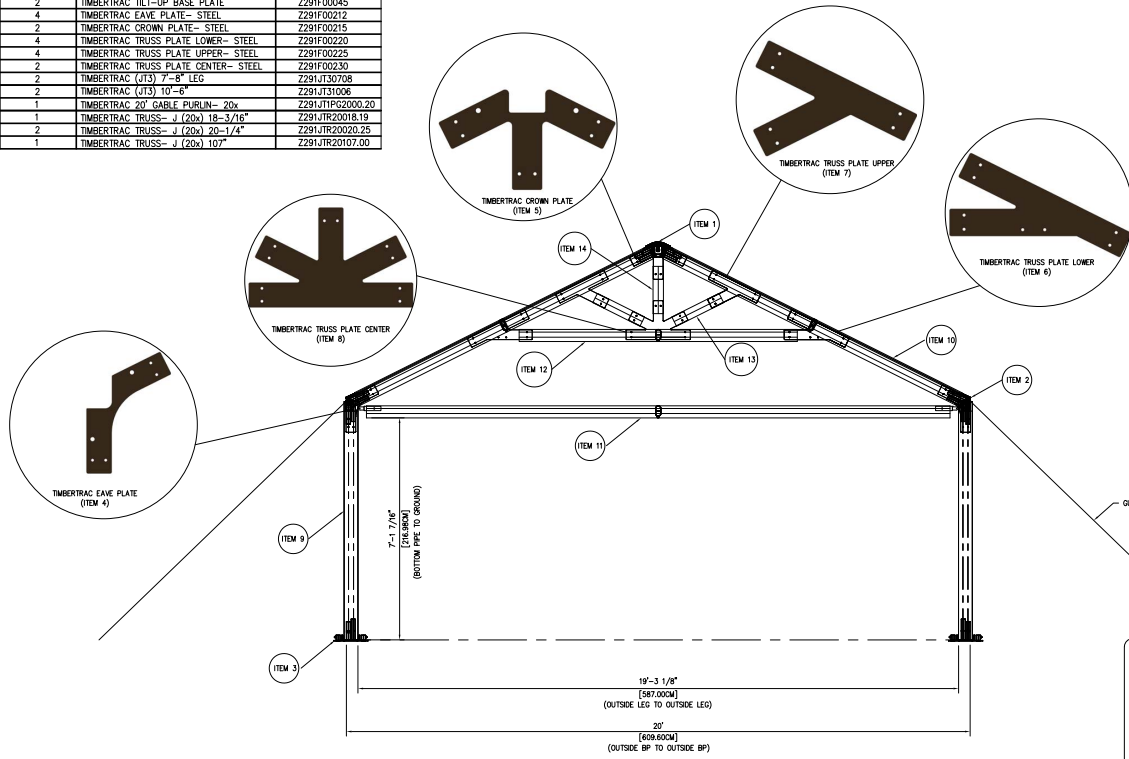

ALL DATA AND INFORMATION CONTAINED IN OR DISCLOSED BY THIS DOCUMENT IS PROPRIETARY INFORMATION OF AZTEC TENTS AND ALL RIGHTS ARE RESERVED. NO PART OF THIS DOCUMENT IS TO BE REPRODUCED, COPIED, OR TRANSMITTED IN ANY FORM OR BY ANY MEANS, ELECTRONIC OR MECHANICAL, INCLUDING PHOTOCOPYING, RECORDING, OR BY ANY INFORMATION STORAGE AND RETRIEVAL SYSTEM, WITHOUT THE EXPRESS WRITTEN PERMISSION OF AZTEC TENTS. REPRODUCTION OF THIS DOCUMENT IN ANY FORM OR BY ANY MEANS, ELECTRONIC OR MECHANICAL, INCLUDING PHOTOCOPYING, RECORDING, OR BY ANY INFORMATION STORAGE AND RETRIEVAL SYSTEM, WITHOUT THE EXPRESS WRITTEN PERMISSION OF AZTEC TENTS, IS STRICTLY PROHIBITED. THIS DOCUMENT IS THE PROPERTY OF AZTEC TENTS AND IS TO BE KEPT CONFIDENTIAL. IT IS TO BE USED ONLY FOR THE SPECIFIC PURPOSE FOR WHICH IT WAS DEVELOPED.

AZTEC TENTS
DESIGN & PRODUCTION
2665 COLUMBIA ST.
CORONA, CA 92623
(951) 238-3887 - FAX (951) 281-0724

TIMBERTRAC FRAME TENT
20'W GABLE END PROFILE
PART NUMBER: Z262200E1508JT

REV.	DESCRIPTION	BY	DATE

PROPRIETARY

ENGINEER: N/A DATE: 7/2/2020
PAGE: 1 OF 1 DRAWN: LYZ

Timbertrac™ 20x (6m) Mid Profile

ITEM	QUANTITY	DESCRIPTION	PART #
1	1	TIMBERTRAC CENTER CROWN	Z291F00015
2	2	TIMBERTRAC SIDE TEE	Z291F00031
3	2	TIMBERTRAC TILT-UP BASE PLATE	Z291F00045
4	4	TIMBERTRAC EAVE PLATE- STEEL	Z291F00212
5	2	TIMBERTRAC CROWN PLATE- STEEL	Z291F00215
6	4	TIMBERTRAC TRUSS PLATE LOWER- STEEL	Z291F00220
7	4	TIMBERTRAC TRUSS PLATE UPPER- STEEL	Z291F00225
8	2	TIMBERTRAC TRUSS PLATE CENTER- STEEL	Z291F00230
9	2	TIMBERTRAC (JTS) 7"-8" LEG	Z291J130708
10	2	TIMBERTRAC (JTS) 10"-8"	Z291J131006
11	1	TIMBERTRAC TRUSS- J (20x) 18-3/16"	Z291JTR20018.19
12	2	TIMBERTRAC TRUSS- J (20x) 20-1/4"	Z291JTR20020.25
13	1	TIMBERTRAC TRUSS- J (20x) 107"	Z291JTR20107.00

20'W (609.6CM) MID TIMBERTRAC PROFILE

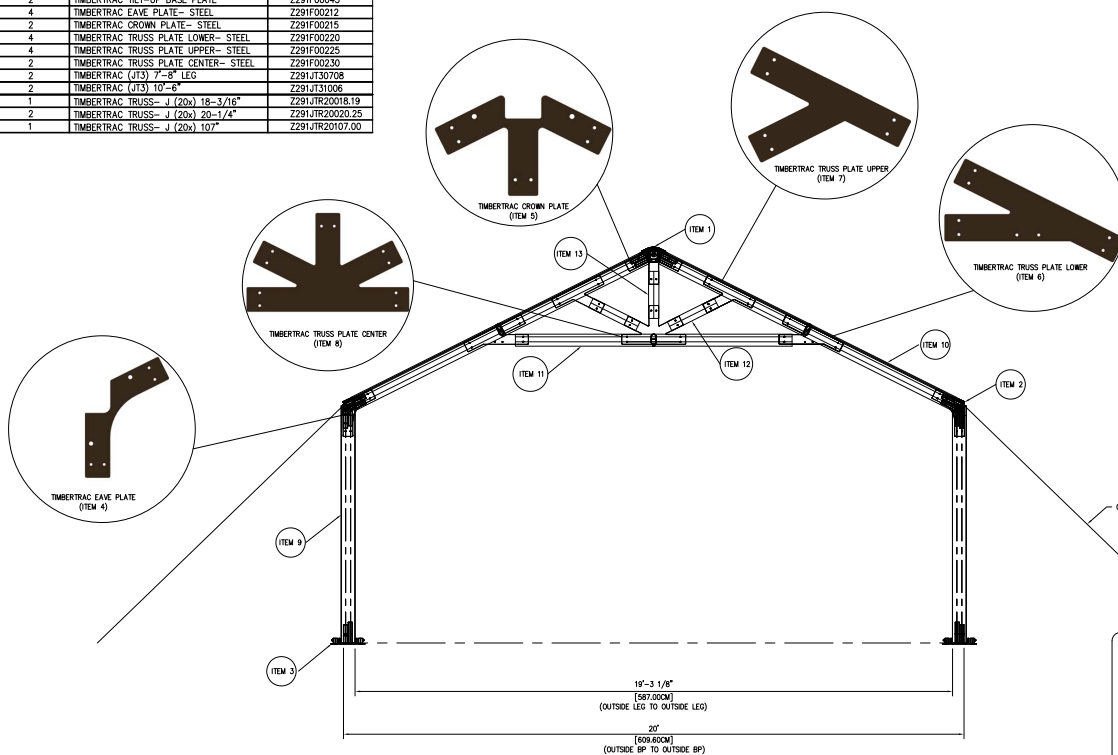

ALL DATA AND INFORMATION CONTAINED IN OR DISCLOSED BY THIS DOCUMENT IS PROPRIETARY INFORMATION OF AZTEC TENTS AND ALL RIGHTS ARE RESERVED. NO PART OF THIS DOCUMENT IS TO BE REPRODUCED, COPIED, OR TRANSMITTED IN ANY FORM OR BY ANY MEANS, ELECTRONIC OR MECHANICAL, INCLUDING PHOTOCOPYING, RECORDING, OR BY ANY INFORMATION STORAGE AND RETRIEVAL SYSTEM, WITHOUT THE EXPRESS WRITTEN PERMISSION OF AZTEC TENTS. REPRODUCTION OF THIS DOCUMENT IN ANY FORM OR BY ANY MEANS, ELECTRONIC OR MECHANICAL, INCLUDING PHOTOCOPYING, RECORDING, OR BY ANY INFORMATION STORAGE AND RETRIEVAL SYSTEM, WITHOUT THE EXPRESS WRITTEN PERMISSION OF AZTEC TENTS, IS STRICTLY PROHIBITED. THIS DOCUMENT IS THE PROPERTY OF AZTEC TENTS AND IS TO BE KEPT CONFIDENTIAL. IT IS TO BE USED ONLY FOR THE SPECIFIC PURPOSE FOR WHICH IT WAS DEVELOPED.

AZTEC TENTS
DESIGN & PRODUCTION
2665 COLUMBIA ST.
CORONA, CA 92623
(951) 238-3887 - FAX (951) 281-0724

TIMBERTRAC FRAME TENT
20'W TIMBERTRAC MID PROFILE
PART NUMBER: Z262200M1508JT

REV.	DESCRIPTION	BY	DATE

PROPRIETARY

ENGINEER: N/A DATE: 7/2/2020
PAGE: 1 OF 1 DRAWN: LYZ

Timbertrac™ 30x (9m) Gable End Profile

ITEM	QUANTITY	DESCRIPTION	PART #
1	1	TIMBERTRAC GABLE CROWN	Z291F00010
2	2	TIMBERTRAC GABLE CORNER (L/R)	Z291F00026/Z291F00027
3	2	TIMBERTRAC TILT-UP BASE PLATE	Z291F00045
4	2	TIMBERTRAC TILT-UP GABLE BASE PLATE	Z291F00050
5	4	TIMBERTRAC EAVE PLATE- STEEL	Z291F00212
6	2	TIMBERTRAC CROWN PLATE- STEEL	Z291F00215
7	4	TIMBERTRAC TRUSS PLATE LOWER- STEEL	Z291F00220
8	4	TIMBERTRAC TRUSS PLATE UPPER- STEEL	Z291F00225
9	2	TIMBERTRAC TRUSS PLATE CENTER- STEEL	Z291F00230
10	2	TIMBERTRAC GABLE UPRIGHT 30x 3'-6" J/I	Z291JTI00306
11	4	TIMBERTRAC (J13) 7'-8" LEG	Z291JTR30708
12	2	TIMBERTRAC (J13) 16'-1"	Z291JTR31601
13	2	TIMBERTRAC 7'-6" GABLE PURLIN-30x	Z291JTIIPG0706
14	1	TIMBERTRAC 15' GABLE PURLIN-30x	Z291JTIIPG1500
15	1	TIMBERTRAC TRUSS- J (30x) 167"	Z291JTR30167.00
16	2	TIMBERTRAC TRUSS- J (30x) 37"	Z291JTR3003700
17	1	TIMBERTRAC TRUSS- J (30x) 33 3/16"	Z291JTR30033.19

30'W(914.4CM) GABLE END TIMBERTRAC PROFILE

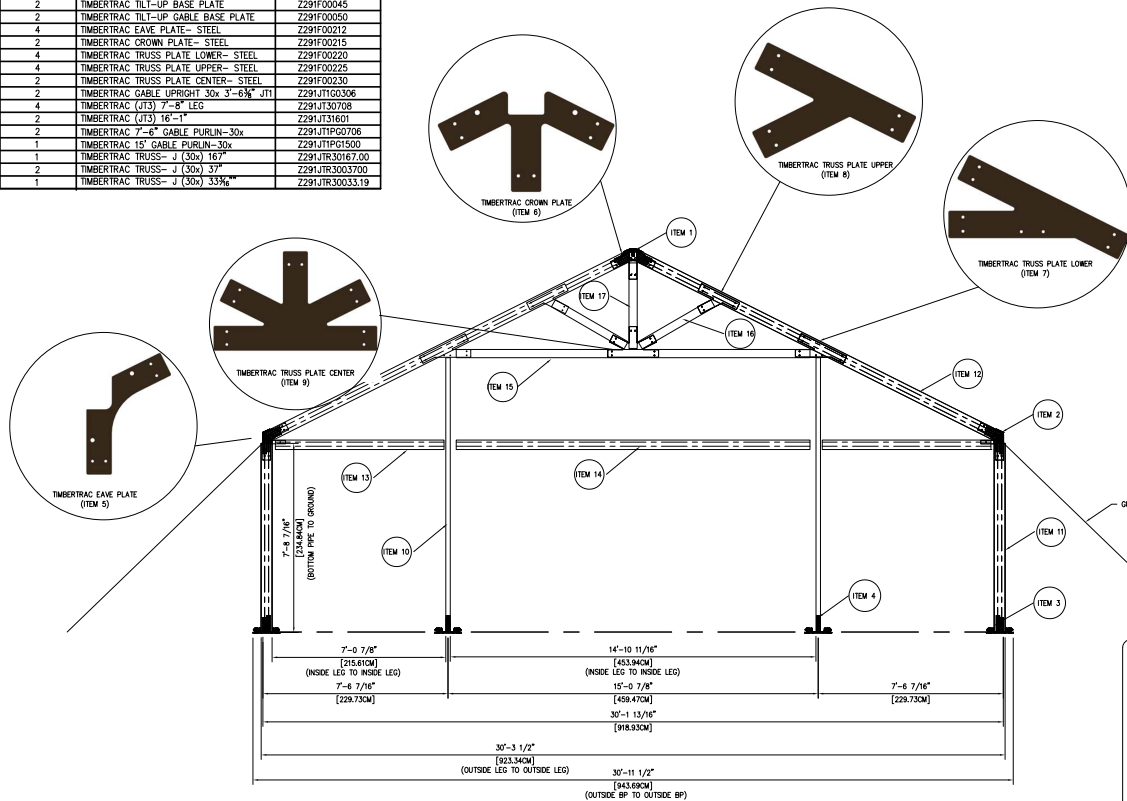

ALL DATA AND INFORMATION CONTAINED HEREIN IS UNCLASSIFIED BY THIS DOCUMENT IS PROPRIETARY INFORMATION OF AZTEC TENTS AND ALL RIGHTS RESERVED. NO PART OF THIS DOCUMENT IS TO BE REPRODUCED, COPIED, OR TRANSMITTED IN ANY FORM OR BY ANY MEANS, ELECTRONIC OR MECHANICAL, INCLUDING PHOTOCOPYING, RECORDING, OR BY ANY INFORMATION STORAGE AND RETRIEVAL SYSTEM, WITHOUT THE EXPRESS WRITTEN PERMISSION OF AZTEC TENTS. EXCEPT TO MEET THE SPECIFIC PURPOSE FOR WHICH IT WAS ISSUED.

AZTEC TENTS
DESIGN & PRODUCTION
2685 COLUMBIA ST. TORRANCE, CA 90503
(800) 222-3887 - FAX (310) 381-0722

TIMBERTRAC FRAME TENT
30'W GABLE END PROFILE
PART NUMBER: Z29230CE1506UT

REV	DESCRIPTION	BY	DATE

PROPRIETARY

ENGINEER: N/A DATE: 5/14/2020
PAGE: 1 OF 1 DRAWN: LYZ

Timbertrac™ 30x (9m) Mid Profile

ITEM	QUANTITY	DESCRIPTION	PART #
1	1	TIMBERTRAC CENTER CROWN	Z291F00015
2	2	TIMBERTRAC SIDE TEE	Z291F00031
3	2	TIMBERTRAC TILT-UP BASE PLATE	Z291F00045
4	4	TIMBERTRAC EAVE PLATE- STEEL	Z291F00212
5	2	TIMBERTRAC CROWN PLATE- STEEL	Z291F00215
6	4	TIMBERTRAC TRUSS PLATE LOWER- STEEL	Z291F00220
7	4	TIMBERTRAC TRUSS PLATE UPPER- STEEL	Z291F00225
8	2	TIMBERTRAC TRUSS PLATE CENTER- STEEL	Z291F00230
9	2	TIMBERTRAC (J13) 7'-8" LEG	Z291JTR30708
10	2	TIMBERTRAC (J13) 16'-1"	Z291JTR31601
11	1	TIMBERTRAC TRUSS- J (30x) 167"	Z291JTR30167.00
12	2	TIMBERTRAC TRUSS- J (30x) 37"	Z291JTR3003700
13	1	TIMBERTRAC TRUSS- J (30x) 33-3/16"	Z291JTR30033.19

30'W(914.4CM) MID TIMBERTRAC PROFILE

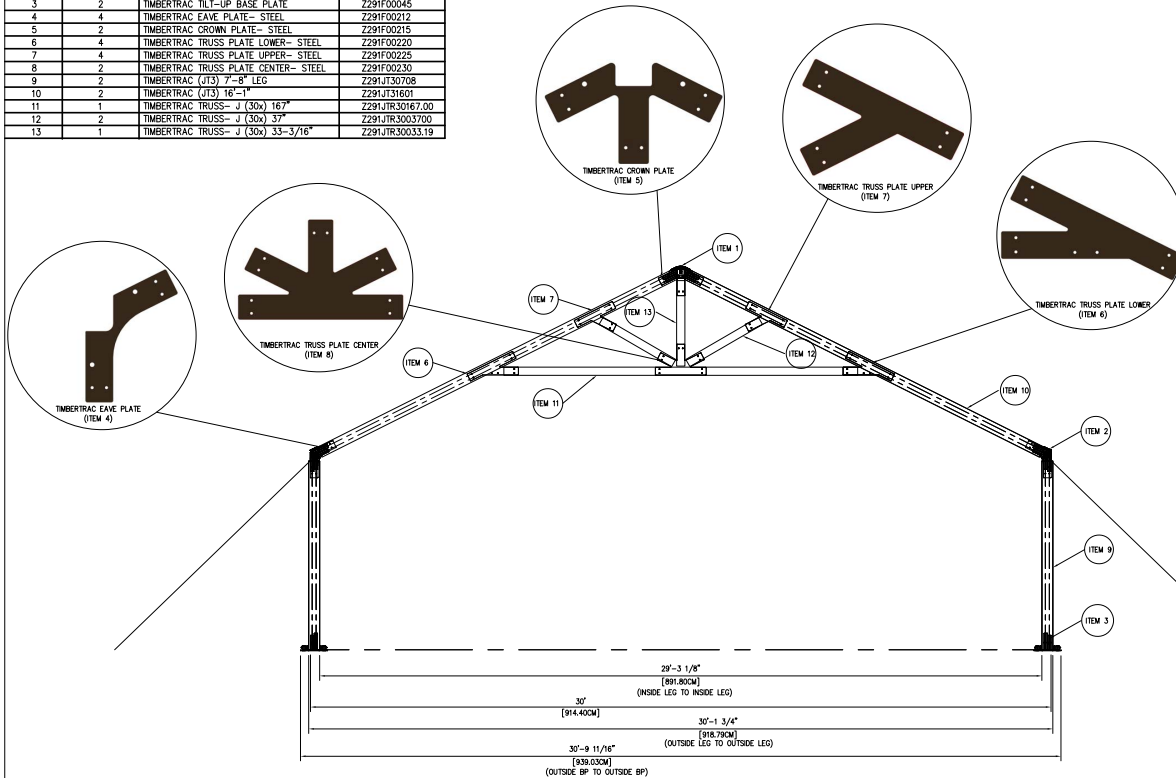

ALL DATA AND INFORMATION CONTAINED HEREIN IS UNCLASSIFIED BY THIS DOCUMENT IS PROPRIETARY INFORMATION OF AZTEC TENTS AND ALL RIGHTS RESERVED. NO PART OF THIS DOCUMENT IS TO BE REPRODUCED, COPIED, OR TRANSMITTED IN ANY FORM OR BY ANY MEANS, ELECTRONIC OR MECHANICAL, INCLUDING PHOTOCOPYING, RECORDING, OR BY ANY INFORMATION STORAGE AND RETRIEVAL SYSTEM, WITHOUT THE EXPRESS WRITTEN PERMISSION OF AZTEC TENTS. EXCEPT TO MEET THE SPECIFIC PURPOSE FOR WHICH IT WAS ISSUED.

AZTEC TENTS
DESIGN & PRODUCTION
2685 COLUMBIA ST. TORRANCE, CA 90503
(800) 222-3887 - FAX (310) 381-0722

TIMBERTRAC FRAME TENT
30'W TIMBERTRAC MID PROFILE
PART NUMBER: Z29230DM1506UT

REV	DESCRIPTION	BY	DATE

PROPRIETARY

ENGINEER: N/A DATE: 5/14/2020
PAGE: 1 OF 1 DRAWN: LYZ

Timbertrac™ 40x (12m) Gable End Profile

ITEM	QUANTITY	DESCRIPTION	PART #
1	1	TIMBERTRAC GABLE CROWN	Z291F00010
2	2	TIMBERTRAC GABLE CORNER (L/R)	Z291F00026/Z291F00027
3	2	TIMBERTRAC TILT-UP BASE PLATE	Z291F00045
4	2	TIMBERTRAC TILT-UP GABLE BASE PLATE	Z291F00050
5	4	TIMBERTRAC EAVE PLATE- STEEL	Z291F00212
6	2	TIMBERTRAC CROWN PLATE- STEEL	Z291F00215
7	4	TIMBERTRAC TRUSS PLATE LOWER- STEEL	Z291F00220
8	4	TIMBERTRAC TRUSS PLATE UPPER- STEEL	Z291F00225
9	2	TIMBERTRAC TRUSS PLATE CENTER- STEEL	Z291F00230
10	2	TIMBERTRAC CABLE UPRIGHT 40x	Z291JT00409
11	4	TIMBERTRAC (JTS) 7"-8" LEG	Z291JT30708
12	2	TIMBERTRAC (JTS) 21"-8"	Z291JT32108
13	2	TIMBERTRAC 10' GABLE PURLIN-40x	Z291JT1PG1000
14	1	TIMBERTRAC 20' GABLE PURLIN-40x	Z291JT1PG2000
15	1	TIMBERTRAC TRUSS- J (40x) 48%	Z291JTR40048.19
16	2	TIMBERTRAC TRUSS- J (40x) 53%	Z291JTR40053.75
17	1	TIMBERTRAC TRUSS- J (40x) 22"	Z291JTR40227.00
18	2	TIMBERTRAC PURLIN PLATE (R/L)	Z291F00235/Z291F00236

40'W(1219.2CM) GABLE END TIMBERTRAC PROFILE

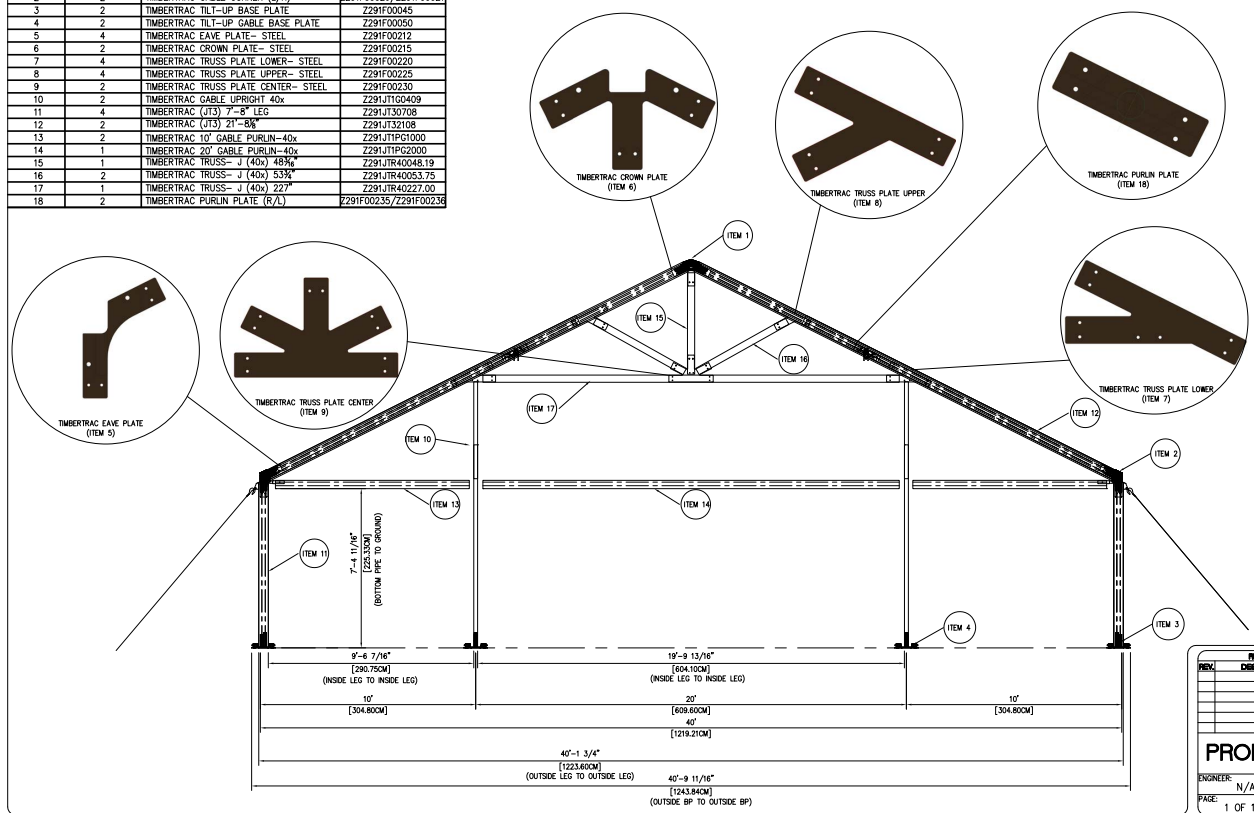

ALL DATA AND INFORMATION CONTAINED IN OR DERIVED BY THIS DOCUMENT IS PROPRIETARY INFORMATION OF AZTECT TENT AND ALL RIGHTS ARE RESERVED. NO PART OF THIS DOCUMENT IS TO BE REPRODUCED, COPIED, OR TRANSMITTED IN ANY FORM OR BY ANY MEANS, ELECTRONIC OR MECHANICAL, INCLUDING PHOTOCOPYING, RECORDING, OR BY ANY INFORMATION STORAGE AND RETRIEVAL SYSTEM, WITHOUT THE EXPRESS WRITTEN PERMISSION OF AZTECT TENT. THIS DOCUMENT IS PROVIDED FOR YOUR INFORMATION ONLY AND IS NOT TO BE USED FOR ANY OTHER PURPOSE. AZTECT TENT IS NOT RESPONSIBLE FOR ANY DAMAGE OR INJURY TO PERSONS OR PROPERTY, INCLUDING THE USE OF THIS DOCUMENT, OR FOR ANY CONSEQUENCES ARISING FROM THE USE OF THIS DOCUMENT, EXCEPT TO THE EXTENT SPECIFICALLY STATED OTHERWISE.

AZTECT TENTS
DESIGN & PRODUCTION
2866 COLUMBIA ST.
CORVALLIS, OR 97331
(503) 228-8887 - FAX (503) 281-0722

TIMBERTRAC FRAME TENT
40'W GABLE END PROFILE
PART NUMBER: Z29240CE1508JT

REV.	DESCRIPTION	BY	DATE

PROPRIETARY

ENGINEER: N/A DATE: 5/14/2020
PAGE: 1 OF 1 DRAWN: LYZ

Timbertrac™ 40x (12m) Mid Profile

ITEM	QUANTITY	DESCRIPTION	PART #
1	1	TIMBERTRAC CENTER CROWN	Z291F00015
2	2	TIMBERTRAC SIDE TIE	Z291F00031
3	2	TIMBERTRAC TILT-UP BASE PLATE	Z291F00045
4	4	TIMBERTRAC EAVE PLATE- STEEL	Z291F00212
5	2	TIMBERTRAC CROWN PLATE- STEEL	Z291F00215
6	4	TIMBERTRAC TRUSS PLATE LOWER- STEEL	Z291F00220
7	4	TIMBERTRAC TRUSS PLATE UPPER- STEEL	Z291F00225
8	2	TIMBERTRAC TRUSS PLATE CENTER- STEEL	Z291F00230
9	2	TIMBERTRAC (JTS) 7"-8" LEG	Z291JT30708
10	2	TIMBERTRAC (JTS) 21"-8"	Z291JT32108
11	1	TIMBERTRAC TRUSS- J (40x) 48%	Z291JTR40048.19
12	2	TIMBERTRAC TRUSS- J (40x) 53%	Z291JTR40053.75
13	1	TIMBERTRAC TRUSS- J (40x) 22"	Z291JTR40227.00
14	2	TIMBERTRAC PURLIN PLATE (R/L)	Z291F00235/Z291F00236

40'W(1219.2CM) MID TIMBERTRAC PROFILE

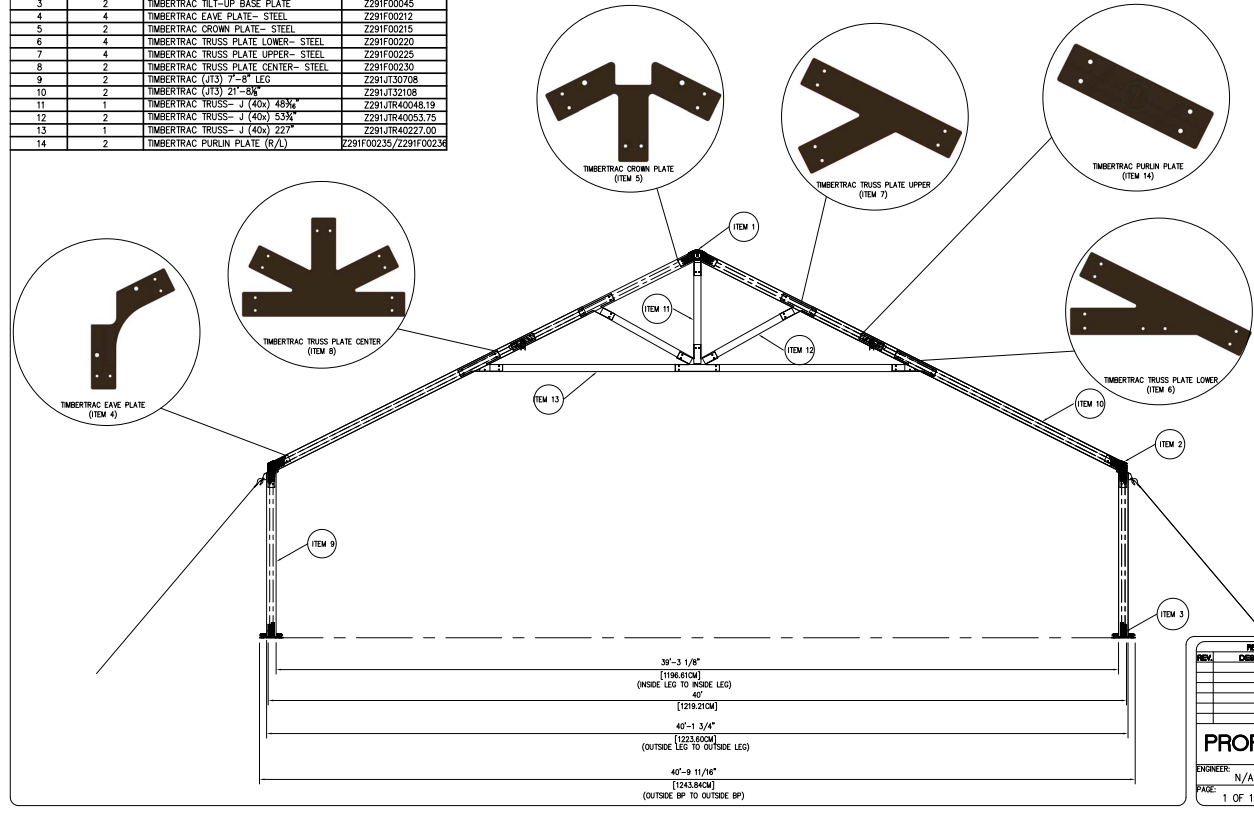

ALL DATA AND INFORMATION CONTAINED IN OR DERIVED BY THIS DOCUMENT IS PROPRIETARY INFORMATION OF AZTECT TENT AND ALL RIGHTS ARE RESERVED. NO PART OF THIS DOCUMENT IS TO BE REPRODUCED, COPIED, OR TRANSMITTED IN ANY FORM OR BY ANY MEANS, ELECTRONIC OR MECHANICAL, INCLUDING PHOTOCOPYING, RECORDING, OR BY ANY INFORMATION STORAGE AND RETRIEVAL SYSTEM, WITHOUT THE EXPRESS WRITTEN PERMISSION OF AZTECT TENT. THIS DOCUMENT IS PROVIDED FOR YOUR INFORMATION ONLY AND IS NOT TO BE USED FOR ANY OTHER PURPOSE. AZTECT TENT IS NOT RESPONSIBLE FOR ANY DAMAGE OR INJURY TO PERSONS OR PROPERTY, INCLUDING THE USE OF THIS DOCUMENT, OR FOR ANY CONSEQUENCES ARISING FROM THE USE OF THIS DOCUMENT, EXCEPT TO THE EXTENT SPECIFICALLY STATED OTHERWISE.

AZTECT TENTS
DESIGN & PRODUCTION
2866 COLUMBIA ST.
CORVALLIS, OR 97331
(503) 228-8887 - FAX (503) 281-0722

TIMBERTRAC FRAME TENT
40'W TIMBERTRAC MID PROFILE
PART NUMBER: Z29240CM1508JT

REV.	DESCRIPTION	BY	DATE

PROPRIETARY

ENGINEER: N/A DATE: 5/14/2020
PAGE: 1 OF 1 DRAWN: LYZ

Timbertrac™ 50x (15m) Gable End Profile

ITEM	QUANTITY	DESCRIPTION	PART #
1	1	TIMBERTRAC GABLE CROWN	Z291F00010
2	2	TIMBERTRAC GABLE CORNER (L/R)	Z291F00026/Z291F00027
3	2	TIMBERTRAC TILT-UP BASE PLATE	Z291F00045
4	2	TIMBERTRAC TILT-UP GABLE BASE PLATE	Z291F00050
5	4	TIMBERTRAC EAVE PLATE- STEEL	Z291F00212
6	2	TIMBERTRAC CROWN PLATE- STEEL	Z291F00215
7	4	TIMBERTRAC TRUSS PLATE LOWER- STEEL	Z291F00220
8	4	TIMBERTRAC TRUSS PLATE UPPER- STEEL	Z291F00225
9	2	TIMBERTRAC TRUSS PLATE CENTER- STEEL	Z291F00230
10	2	TIMBERTRAC CABLE UPRIGHT 50x	Z291JT103011
11	4	TIMBERTRAC (JT3) 7'-8" LEG	Z291JT30708
12	2	TIMBERTRAC (JT3) 5'-7 1/2" (50x)	Z291JT30507
13	2	TIMBERTRAC (JT3) 21'-8 1/2"	Z291JT32108
14	2	TIMBERTRAC 15' GABLE PURLIN-50x	Z291JT1P15005
15	1	TIMBERTRAC 20' GABLE PURLIN-40x	Z291JT1P20300
16	1	TIMBERTRAC TRUSS- J (40x) 48 3/4"	Z291JTR40048.19
17	2	TIMBERTRAC TRUSS- J (40x) 53 3/4"	Z291JTR40053.75
18	1	TIMBERTRAC TRUSS- J (40x) 227"	Z291JTR40227.00
19	2	TIMBERTRAC PURLIN PLATE (R/L)	Z291F00235/Z291F00236

50'W(1524CM) GABLE END TIMBERTRAC PROFILE

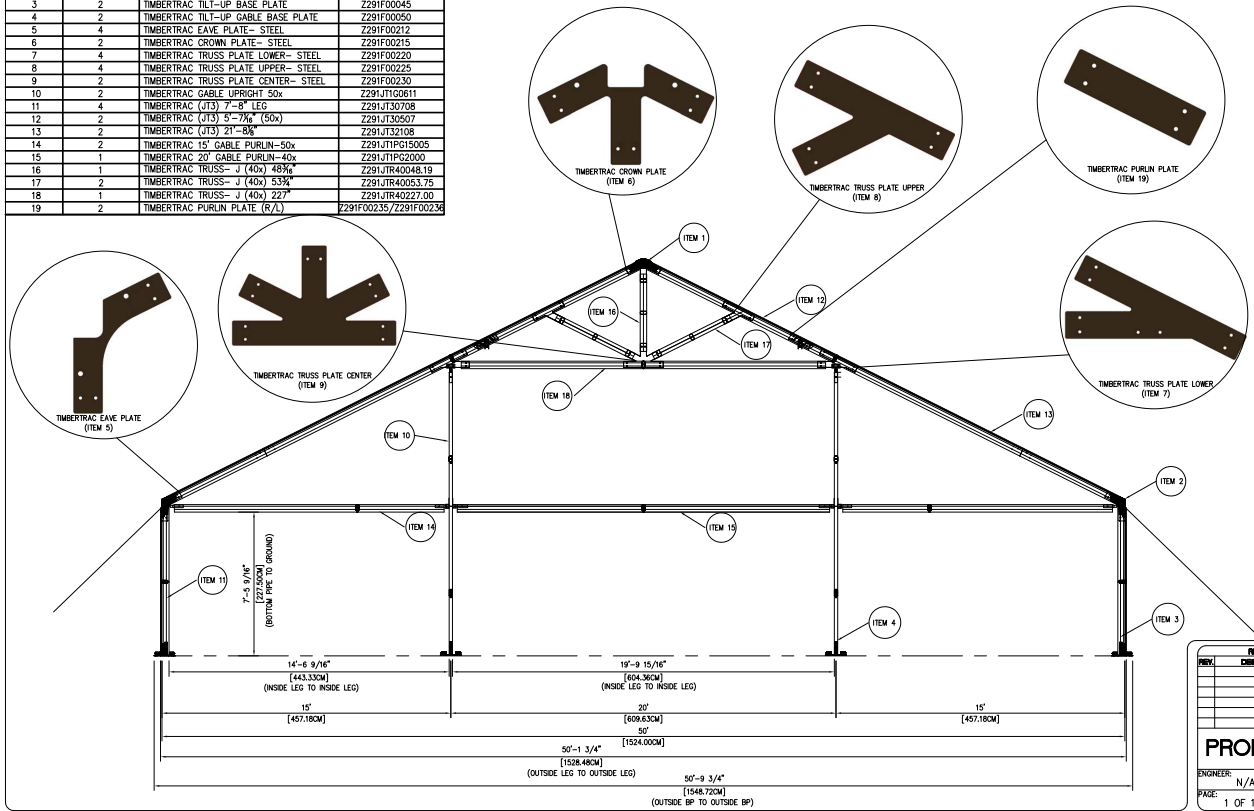

ALL DATA AND INFORMATION CONTAINED IN OR DISCLOSED BY THIS DOCUMENT IS PROPRIETARY INFORMATION OF AZTEC TENTS AND ALL RIGHTS THEREIN ARE RESERVED. NO PART OF THIS DOCUMENT IS TO BE REPRODUCED, COPIED, OR TRANSMITTED IN ANY FORM OR BY ANY MEANS, ELECTRONIC OR MECHANICAL, INCLUDING PHOTOCOPYING, RECORDING, OR BY ANY INFORMATION STORAGE AND RETRIEVAL SYSTEM, WITHOUT THE WRITTEN PERMISSION OF AZTEC TENTS. EXCEPT TO MEET THE SPECIFIC PURPOSE FOR WHICH IT WAS OBTAINED.

AZTEC TENTS
DESIGN & PRODUCTION
2665 COLUMBIA ST.
ORANGE, CA 92653
(909) 228-5887 - FAX (916) 381-0722

TIMBERTRAC FRAME TENT
50'W GABLE END PROFILE
PART NUMBER: Z292500E1508JT

REV.	DESCRIPTION	DATE

PROPRIETARY
ENGINEER: N/A DATE: 5/19/2020
PAGE: 1 OF 1 DRAWN: LYZ

Timbertrac™ 50x (15m) Mid Profile

ITEM	QUANTITY	DESCRIPTION	PART #
1	1	TIMBERTRAC CENTER CROWN	Z291F00015
2	2	TIMBERTRAC SIDE TEE	Z291F00031
3	2	TIMBERTRAC TILT-UP BASE PLATE	Z291F00045
4	4	TIMBERTRAC EAVE PLATE- STEEL	Z291F00212
5	2	TIMBERTRAC CROWN PLATE- STEEL	Z291F00215
6	4	TIMBERTRAC TRUSS PLATE LOWER- STEEL	Z291F00220
7	4	TIMBERTRAC TRUSS PLATE UPPER- STEEL	Z291F00225
8	2	TIMBERTRAC TRUSS PLATE CENTER- STEEL	Z291F00230
9	2	TIMBERTRAC (JT3) 7'-8" LEG	Z291JT30708
10	2	TIMBERTRAC (JT3) 21'-8 1/2"	Z291JT32108
11	1	TIMBERTRAC TRUSS- J (40x) 48 3/4"	Z291JTR40048.19
12	2	TIMBERTRAC TRUSS- J (40x) 53 3/4"	Z291JTR40053.75
13	1	TIMBERTRAC TRUSS- J (40x) 227"	Z291JTR40227.00
14	2	TIMBERTRAC PURLIN PLATE (R/L)	Z291F00235/Z291F00236
15	2	TIMBERTRAC JT3 5'-7 1/2" (50x)	Z291JTR30507

50'W(1524CM) MID TIMBERTRAC PROFILE

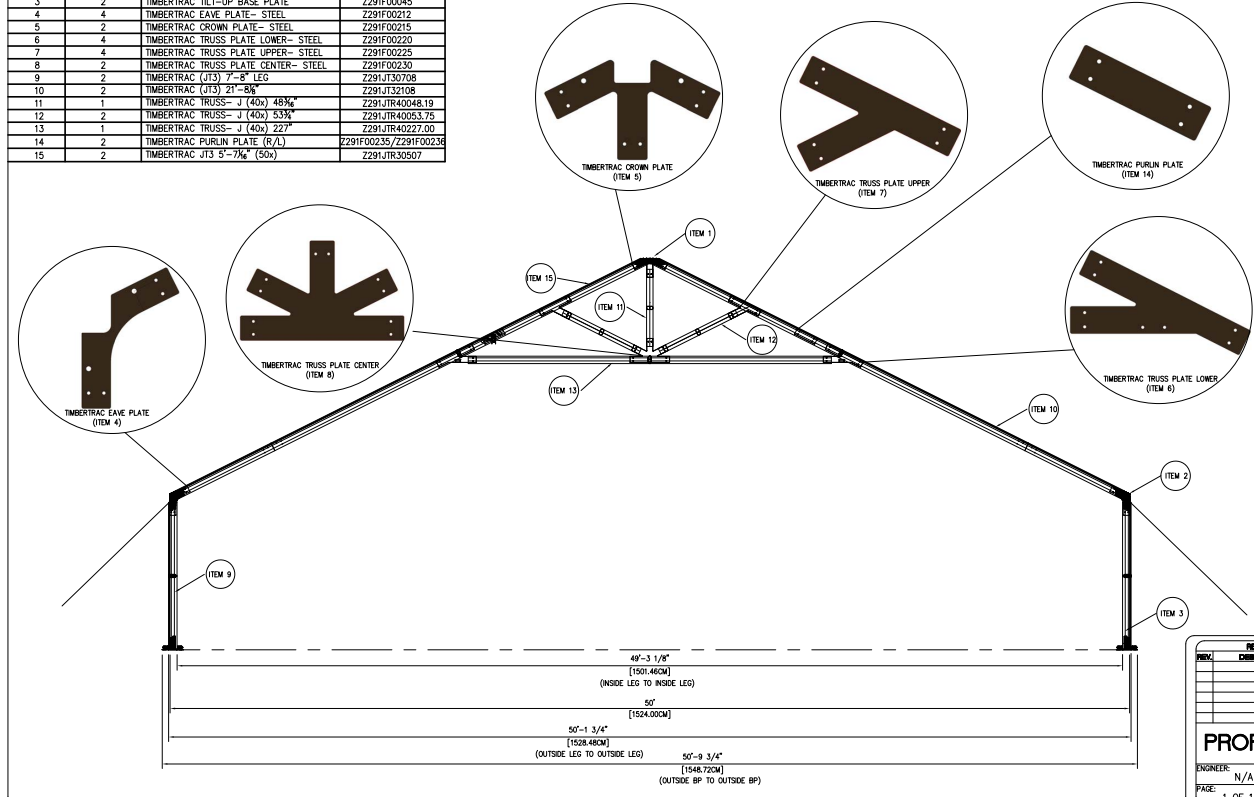

ALL DATA AND INFORMATION CONTAINED IN OR DISCLOSED BY THIS DOCUMENT IS PROPRIETARY INFORMATION OF AZTEC TENTS AND ALL RIGHTS THEREIN ARE RESERVED. NO PART OF THIS DOCUMENT IS TO BE REPRODUCED, COPIED, OR TRANSMITTED IN ANY FORM OR BY ANY MEANS, ELECTRONIC OR MECHANICAL, INCLUDING PHOTOCOPYING, RECORDING, OR BY ANY INFORMATION STORAGE AND RETRIEVAL SYSTEM, WITHOUT THE WRITTEN PERMISSION OF AZTEC TENTS. EXCEPT TO MEET THE SPECIFIC PURPOSE FOR WHICH IT WAS OBTAINED.

AZTEC TENTS
DESIGN & PRODUCTION
2665 COLUMBIA ST.
ORANGE, CA 92653
(909) 228-5887 - FAX (916) 381-0722

TIMBERTRAC FRAME TENT
50'W TIMBERTRAC MID PROFILE
PART NUMBER: Z292500M1508JT

REV.	DESCRIPTION	DATE

PROPRIETARY
ENGINEER: N/A DATE: 5/14/2020
PAGE: 1 OF 1 DRAWN: LYZ

Timbertrac™ Portal Brace

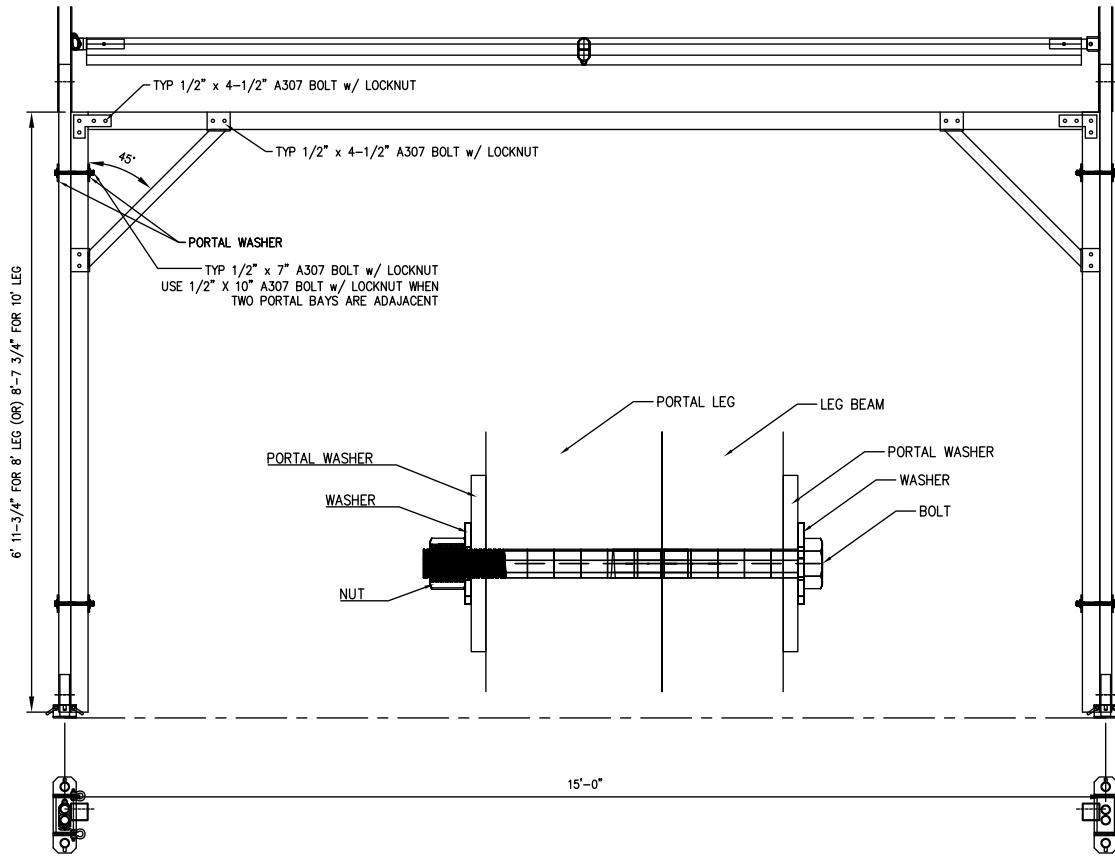

Timbertrac™ Bolt Diagram

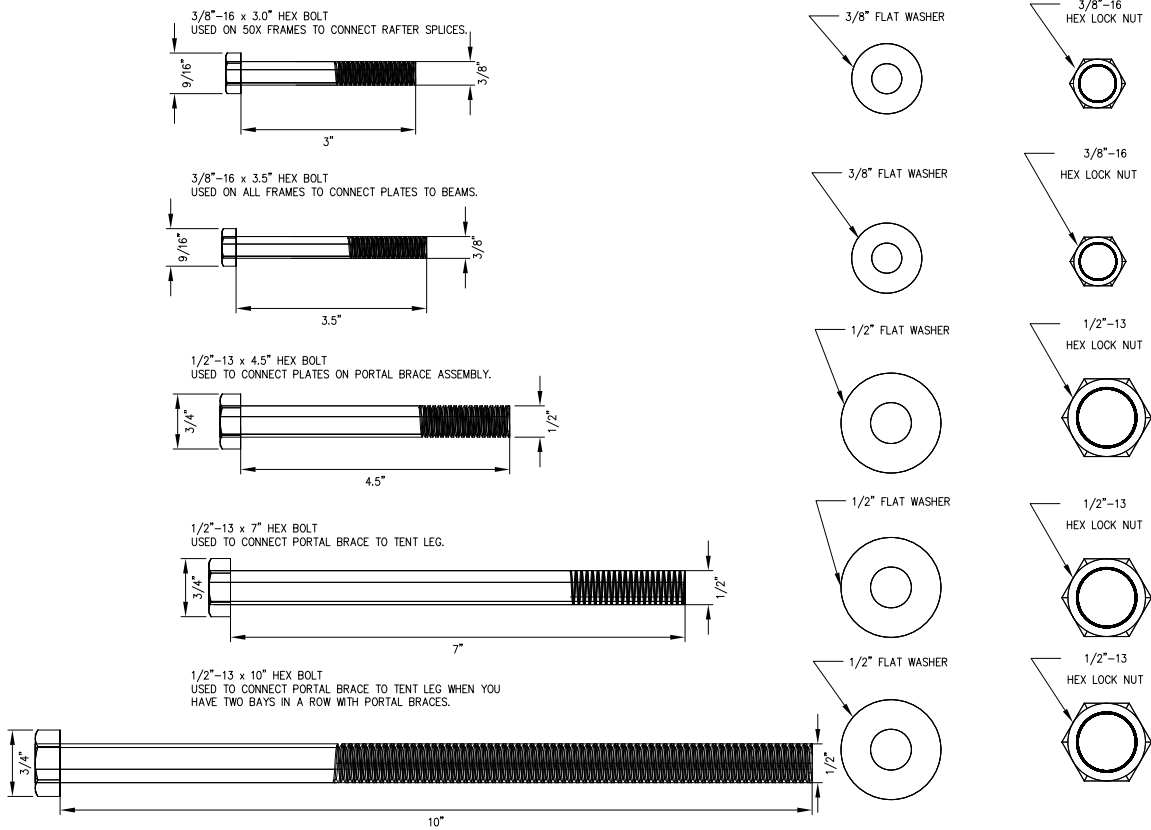

Timbertrac™ Parts Images



Timbertrac Gable Crown



Timbertrac Center Crown



Timbertrac Gable Corner Left



Timbertrac Gable Corner Right



Timbertrac Side Tee



Timbertrac Rafter Extension Beam -18"



Timbertrac Tensioner



Timbertrac Tilt-up Baseplate



Timbertrac Tilt-up Gable Baseplate



Timbertrac Hinge Purlin End



Timbertrac Drop-In Purlin End



Timbertrac Gable Top Bracket



Timbertrac 3/8 x 3" Bolt Assy - Black



Timbertrac 3/8 x 3 1/2 Bolt Assy -Black



Timbertrac 3/8 x 1 1/2 Bolt Assy -Black

Timbertrac™ Parts Images



Timbertrac 1/2 x 4 Bolt Assy -Black



Timbertrac 1/2 x10 Bolt Assy -Black



Timbertrac Eave Plate - Aluminum

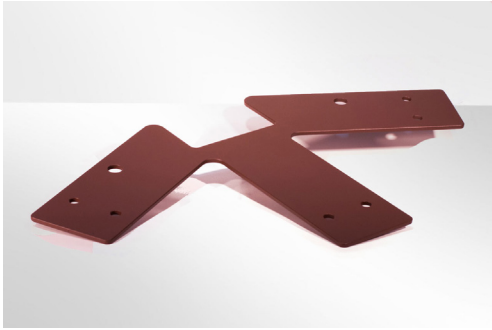

Timbertrac Crown Plate - Aluminum

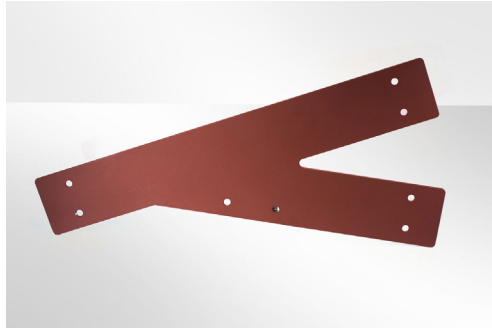

Timbertrac Truss Plate Lower



Timbertrac Truss Plate Upper

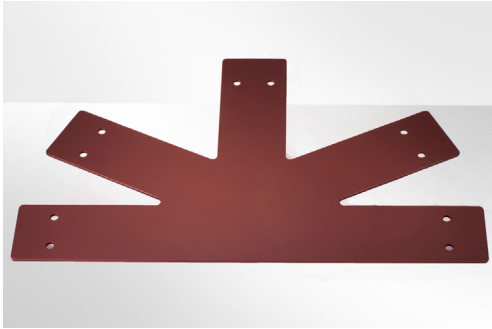

Timbertrac Truss Plate Center

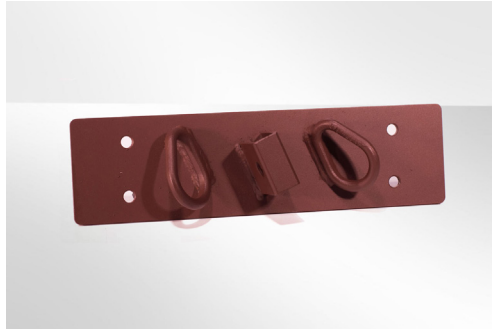

Timbertrac Purlin Plate Right



Timbertrac Purlin Plate Left



Timbertrac Purlin Plate-Plain



Timbertrac Portal Corner Brace

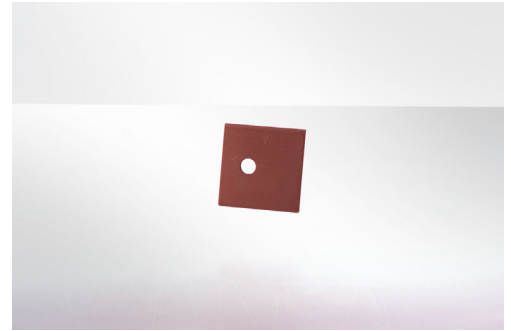

Timbertrac Portal Brace Shim



Timbertrac Portal Brace Corner P



Push Button V Black



Timbertrac Roof Cable

Timbertrac™ Parts Images



Timbertrac Wall Cable



Timbertrac Ratchet Tensioner



Jumbotrak Keder Rail Repair Tool



1/2 Polydac x 65' Pullrope Set

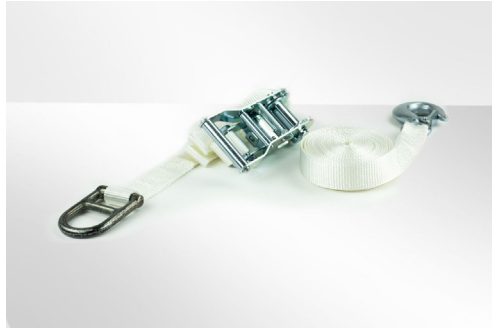

1" Inline Ratchet w10' Web Guy



2" Inline Ratchet w12' Web Guy



11mm Keder Leader Set



1" x 42" Double Head Stake



Mid-Span Tensioner -Timbertrac

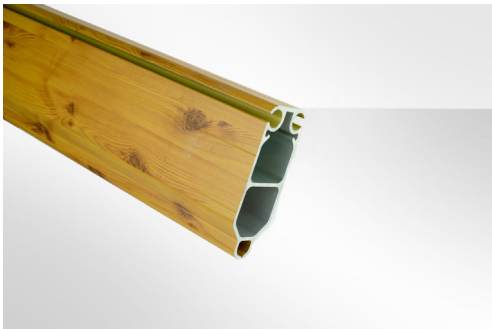

Timbertrac JT3 Extrusion

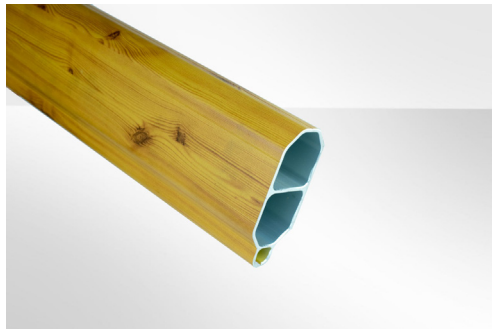

Timbertrac JT1 Extrusion

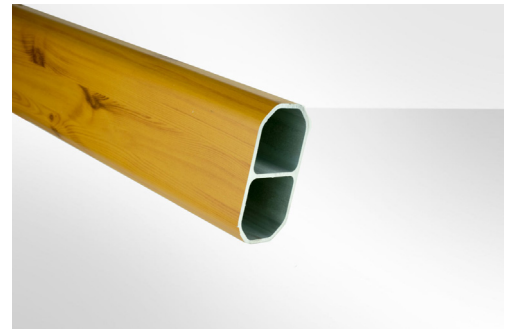

Timbertrac Truss Extrusion



JT Purlin Tool



JT Push Button Tool



Handheld Keder Feeder

Timbertrac™ Parts Images



JT Eye Bolt & Dowel Nut Hanger



1/2" Polydac x 65' Pullrope (Set)



Patch Taps B/O 3"



JT Installer Toolbag Kit



Tent Cleaning Solution



HH-66 Vinyl Glue (4oz)



Liquid Vinyl Patch (4oz)

Timbertrac™ Engineering Specifications

Design Criteria: 20'x, 30'x, 40'x and 50'x Timbertrac Systems
Code: ASCE 7-16, 2021 IBC, 2022 CBC
Wind Speed: 110 mph (177 kph) 3-Second Gust Exposure C
Temporary Installation of 179 days or less
Mean Recurrence Interval (MRI): 7.5 Years
Effective Wind Speed after C26.5-1 Reductions: 75 mph (120kph)
Loads calculated on effective wind speed

Notes:
External Guys to be installed at 45 degree from horizontal

Provide 1/4" cable cross bracing @ rafter/spreader @ each gable end per gable setup & every 100' as length (hip or gable) requires. Tent not to be located near abrupt changes in topography.

Hanging Loads: Maximum load of 150lbs (68kg) per beam arch. Maximum 50lb (22kg) loading per point.

In the event that this tent is used during the winter months, additional precautions must be taken. The tent must be heated at all times while occupied. If there is snow accumulation, the tent must be evacuated and the snow must be removed from the tent structure before reoccupying the space.

The tent should be evacuated if winds exceed 38 mph (61 kph). If wind gusts of 60 mph (96 kph) or greater are forecasted the tent shall not be occupied and time permitting, be disassembled and removed from the site.

Soil conditions will vary from site to site. The included anchoring package for this tent may need to be supplemented with additional or alternate anchoring to meet the loads below. The below chart lists the required resistance loads that must be supported by the anchoring system to meet the engineering loads specified under the code.

A Factor of Safety of 2.0 times the design load has been used for the pull out tension in lbs that the anchoring devices must resist in the direction of the load. Ensure that the anchors installed are adequate to resist pull out loads show on the diagram. Actual testing of some individual anchors to 75% of the anchor pull-out load is recommended.

Timbertrac™ Load Summary- 20' (6m) Width

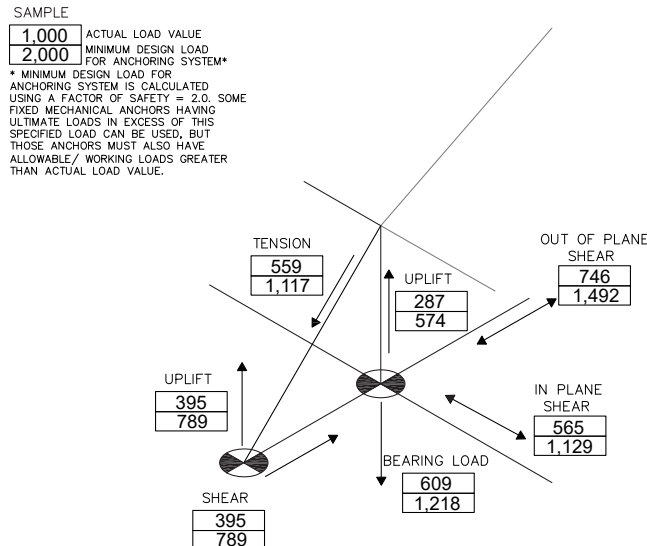

Timbertrac™ Load Summary- 30' (9m) Width

SAMPLE

1,000 ACTUAL LOAD VALUE
2,000 MINIMUM DESIGN LOAD FOR ANCHORING SYSTEM*

* MINIMUM DESIGN LOAD FOR ANCHORING SYSTEM IS CALCULATED USING A FACTOR OF SAFETY = 2.0. SOME FIXED MECHANICAL ANCHORS HAVING ULTIMATE LOADS IN EXCESS OF THIS SPECIFIED LOAD CAN BE USED, BUT THOSE ANCHORS MUST ALSO HAVE ALLOWABLE / WORKING LOADS GREATER THAN ACTUAL LOAD VALUE.

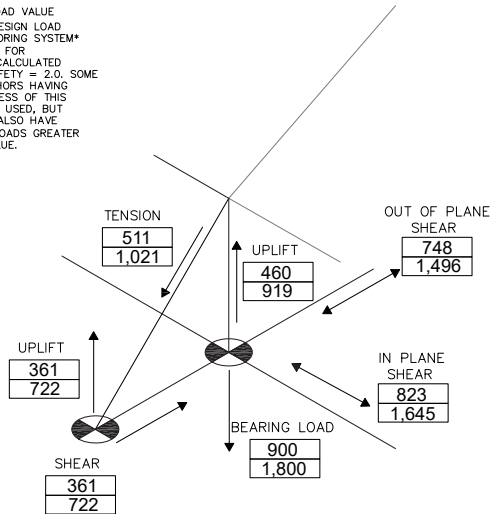

Timbertrac™ Load Summary- 40' (12m) Width

SAMPLE

1,000 ACTUAL LOAD VALUE
2,000 MINIMUM DESIGN LOAD FOR ANCHORING SYSTEM*

* MINIMUM DESIGN LOAD FOR ANCHORING SYSTEM IS CALCULATED USING A FACTOR OF SAFETY = 2.0. SOME FIXED MECHANICAL ANCHORS HAVING ULTIMATE LOADS IN EXCESS OF THIS SPECIFIED LOAD CAN BE USED, BUT THOSE ANCHORS MUST ALSO HAVE ALLOWABLE / WORKING LOADS GREATER THAN ACTUAL LOAD VALUE.

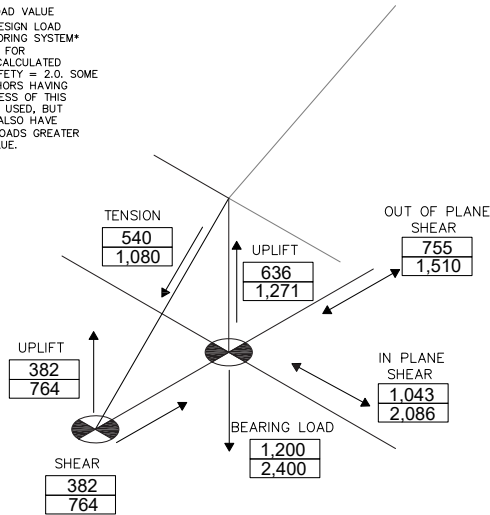

Timbertrac™ Load Summary- 50' (15m) Width

SAMPLE

1,000 ACTUAL LOAD VALUE
2,000 MINIMUM DESIGN LOAD FOR ANCHORING SYSTEM*

* MINIMUM DESIGN LOAD FOR ANCHORING SYSTEM IS CALCULATED USING A FACTOR OF SAFETY = 2.0. SOME FIXED MECHANICAL ANCHORS HAVING ULTIMATE LOADS IN EXCESS OF THIS SPECIFIED LOAD CAN BE USED, BUT THOSE ANCHORS MUST ALSO HAVE ALLOWABLE / WORKING LOADS GREATER THAN ACTUAL LOAD VALUE.

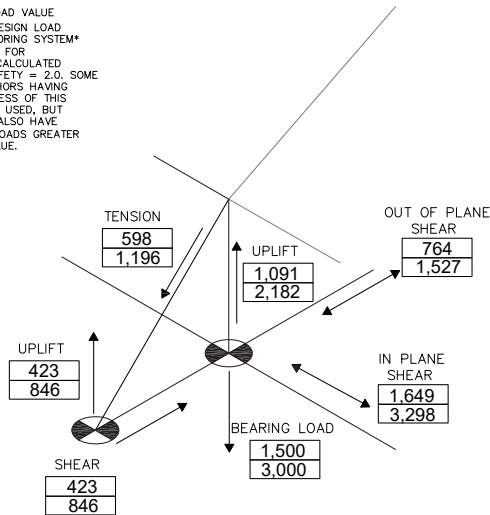

Timbertrac™ Components

Fittings/Components	Item Number
Timbertrac Gable Crown	Z291F00010
Timbertrac Center Crown	Z291F00015
Timbertrac X-Gable Corner Left	Z291F00020
Timbertrac X-Gable Corner Right	Z291F00025
Timbertrac Gable Corner Left	Z291F00026
Timbertrac Gable Corner Right	Z291F00027
Timbertrac X-Side Tee	Z291F00030
Timbertrac Side Tee	Z291F00031
Timbertrac Rafter Ext Beam-18"	Z291F00035
Timbertrac Tensioner 3/4"	Z291F00040
Timbertrac Tilt-Up Baseplate	Z291F00045
Timbertrac Tilt-Up Gable Base	Z291F00050
Timbertrac Adj. Tilt-Up Base	Z291F00055
Timbertrac Adj. Tilt-Up Gable	Z291F00060
Timbertrac Hinge Purlin End	Z291F00065
Timbertrac Drop-In Purlin End	Z291F00070
Timbertrac Gable Top Bracket	Z291F00071
Mid-Span Tensioner -Timbertrac	Z291F00072
Timbertrac Assembly Cable Brac	Z291F00073
Timbertrac Keder Tension Ring	Z291F00074
	Z291F00075
3/8" x 3" Bolt Assy - Black	
3/8" x 3 1/2" Bolt Assy -Black	Z291F00080
3/8" x 1 1/2" Bolt Assy -Black	Z291F00085
1/2" x 4 1/2" Bolt Assy -Black	Z291F00090
1/2" x 7" Bolt Assy -Black	Z291F00095
1/2" x 10" Bolt Assy -Black	Z291F00100
Timbertrac X-Eave Plate - Alum	Z291F00210
Timbertrac X-Eave Plate - RAW	Z291F00210R
Timbertrac Eave Plate - Alum.	Z291F00212
Timbertrac Eave Plate - RAW	Z291F00212R
Timbertrac Crown Plate - Alum.	Z291F00215
Timbertrac Crown Plate - RAW	Z291F00215R
Timbertrac Truss Plate Lower -	Z291F00220
Timbertrac Truss Plate Low RAW	Z291F00220R
Timbertrac Truss Plate Upper -	Z291F00225
Timbertrac Truss Plate Up RAW	Z291F00225R
Timbertrac Truss Plate Center	Z291F00230
Timbertrac Truss Plate Ctr RAW	Z291F00230R
Timbertrac Purlin Plate Right	Z291F00235
Timbertrac Purlin Plate Left	Z291F00236
Timbertrac Purlin Plate-Plain	Z291F00240
Timbertrac Purlin Plate RAW	Z291F00240R
TimberTrac Portal Brace Header	Z291F00300
TimberTrac Portal 8' Leg	Z291F00301
TimberTrac Portal 10' Leg	Z291F00302
TimberTrac Portal Corner Brace	Z291F00303
TimberTrac Portal Brace Shim	Z291F00304
TimberTrac PB Shim RAW	Z291F00304R
TimberTrac Port. Brace Corner P	Z291F00305
TimberTrac PB Corner Plt. RAW	Z291F00305R
Timbertrac Portal Brace 8x15 B	Z291F00310
Timbertrac Portal Brace 10x15	Z291F00315
Push Button "V" 3/8" Black	Z291F00320BK

Cables	Item Number
Timbertrac Roof Cable 20x15 -	Z291F00410
Timbertrac Roof Cable 30x15 -	Z291F00415
Timbertrac Roof Cable 40x15 -	Z291F00425
Timbertrac Roof Cable 40x15 -	Z291F00430
Timbertrac Roof Cable 50x15 -	Z291F00433
Timbertrac Wall Cable 8' Legx15	Z291F00435
Timbertrac Wall Cable 10' Leg	Z291F00440
Timbertrac Assembly Cable 50x	Z291F00600

Aluminum Beams	Item Number
Timbertrac JT1 19'04"	Z291JT11904
Timbertrac Gable Upright 30x	Z291JT1G0306
Timbertrac Gable Upright 40x	Z291JT1G0409
Timbertrac Gable Upright 50x	Z291JT1G0611
Timbertrac 7'6" Gab Purlin-30x	Z291JT1PG0706
Timbertrac 10' Gab Purlin-40x	Z291JT1PG1000
Timbertrac 15' Gab Purlin-30x	Z291JT1PG1500
Timbertrac 15' Gab Purlin-50x	Z291JT1PG15005
Timbertrac 20' Gab Purlin-40x	Z291JT1PG2000
Timbertrac 20' Gab Purlin-20x	Z291JT1PG2000.20
Timbertrac Purlin 15'	Z291JT1PS1500
Timbertrac JT3 5'7-1/16" (50x Ext)	Z291JT30507
Timbertrac JT3 7'8" Leg	Z291JT30708
Timbertrac JT3 9'4" Leg	Z291JT30904
Timbertrac JT3 10'6"	Z291JT31006
Timbertrac JT3 16'1"	Z291JT31601
Timbertrac JT3 21' 8-1/8"	Z291JT32108
Timbertrac JT3 21' 10"	Z291JT32110
Timbertrac Truss - 19'4" RAW	Z291JTR1904
Timbertrac Truss-J 20x 18-3/16	Z291JTR20018.19
Timbertrac Truss-J 20x 20-1/4"	Z291JTR20020.25
Timbertrac Truss-JT1 20x 107"	Z291JTR20107.00
Timbertrac Truss-J 30x 33-3/16	Z291JTR30033.19
Timbertrac Truss-J 30x 37"	Z291JTR30037.00
Timbertrac Truss-JT1 30x 167"	Z291JTR30167.00
Timbertrac Truss-J 40x 48-3/16	Z291JTR40048.19
Timbertrac Truss-J 40x 53-3/4"	Z291JTR40053.75
Timbertrac Truss-JT1 40x 227"	Z291JTR40227.00

Anchoring/Accessories	
1" x 42" Double Headed Stake	Z51100070
Stake Cap - White Plastic	Z51100075
JT Push Button Tool	Z298F00318
24" Stake Bar	Z39900300
1" Inline Ratchet w/10' Web Guy	Z39900280
2" Inline Ratchet w/12' Web Guy	Z39900290
WebBlaster Web Winder	Z39900295

If YOU can IMAGINE it... WE can BUILD it

www.aztectents.com

Aztec Tents

2665 Columbia Street
Torrance, CA 90503
Toll Free (800) 228-3687
Fax (310) 381-0722