

- 4.) Increasing the height of the stake knot above the ground decreases stake holding capacity.

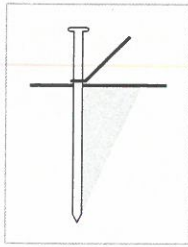

Figure 15. Stake Knot Height

- 5.) Holding power varies with anchor types.

6.) **DOUBLE STAKING**

Double staking is the practice of driving another stake a short distance behind the primary stake and close-tying both stakes together with the free end of the guy rope.

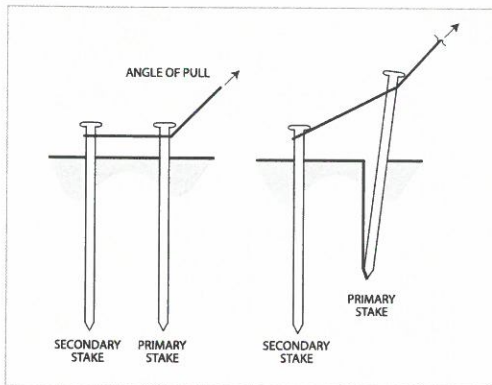

Figure 17. Double Staking

A rule of thumb for double staking suggests that the distance between stakes be equal to one-third the depth of the stakes in the ground.

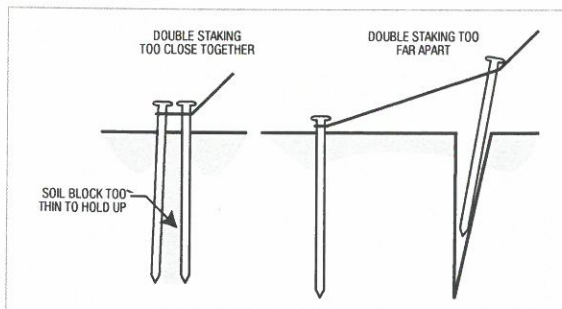

Figure 18. Double Staking Errors

Compliments of:



Copyright 2006 by the Tent Rental Division of the Industrial Fabrics Association International

All rights reserved.

No part of the contents of this handout may be reproduced or transmitted in any form or by any means without the written permission of the publisher.

NOTICE AND DISCLAIMER

Industrial Fabrics Association International makes no representation or warranty, either express or implied as to:

- (1) the fitness for any particular purpose of any of the information, designs, or standards contained in this manual or any products manufactured or constructed in accordance therewith; or
- (2) merchantability of any such information, designs, standards, or products; or
- (3) the accuracy, quality, or reliability of any such information, designs, standards, products.

The use by any individual or entity of any such information, designs, standards, or products constitutes an acknowledgment and agreement by such individual or entity that Industrial Fabrics Association International has made no representation or warranty with respect to the fitness, merchantability, or quality of such information, designs, standards or products.

This handout supplements any instructions or warnings that are provided by the manufacturer of the tent. You should consult the manufacturer's instructions and warnings each time you install a tent. This handout does not replace the manufacturer's instructions and warnings. If you are unable to locate any instructions or warnings, consult your rental agent or the manufacturer. To avoid personal injury or property damage, read and follow the manufacturer's instructions and warnings and the supplement information contained in the IFAI Procedural Handbook for the Safe Installation and Maintenance of Tentage before you install a tent. In the event there is a conflict between the manufacturer's instructions and warnings and the instructions contained in this manual, always follow the manufacturer's instructions and warnings.

Industrial Fabrics Association International
1801 County Road B W., Roseville, MN 55113-4061 USA
+1 651 222 2508 * 800 225 4324 * Fax +1 651 631 9334



Pocket Guide

Pullout Capacity of Tent Stakes

IFAI division

www.tentexperts.org

Copyright 2006 IFAI Tent Rental Division

A) Systematic Approach to Stakes

- 1.) The larger the stake diameter, the greater the holding power.

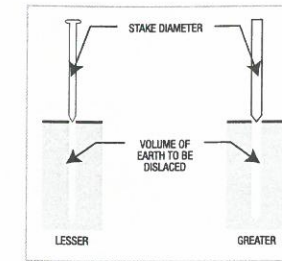

Figure 8. Stake Performance & Volume of Displaced Earth

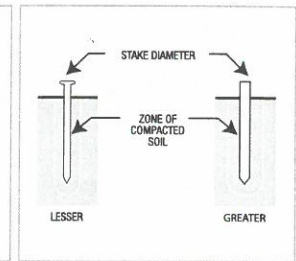

Figure 9. Stake Performance & Zone of Displaced Earth

- 2.) The deeper the stake, the greater the holding power.

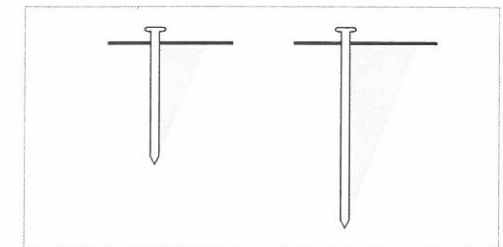

Figure 11. Soil Wedge (Bulb) Size and Sideways Resistance

- 3.) Optimum guy rope angle provides optimum holding power.

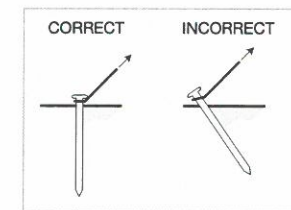

Figure 13. Stake Driving Angle

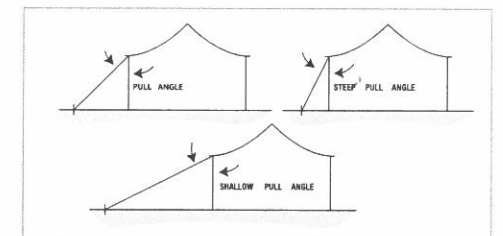

Figure 14. Pull Angles and Stake Location

B) Estimating Pullout Capacity of Tent Stakes

An outline for estimating pullout capacity for tent stakes is described in this pocket guide. The complete Staking Study Summary is included in the IFAI Procedural Handbook for the Safe Installation and Maintenance of Tentage available for purchase by visiting www.bookstore.ifai.com.

Pullout Capacity for a Single Stake

The method estimates the stake pullout capacity for a “baseline” stake, and then applies correction factors for conditions that vary from the baseline case.

The baseline case for a tent stake is as follows:

- 1) stake diameter is 1.0 inch
- 2) the side of the stake is smooth
- 3) the steel stake is driven vertically
- 4) the stake is embedded (driven) 36 inches in the ground
- 5) The load is fastened at 2 inches above the ground surface, and
- 6) The load is pulled at a 45 degree angle.

Estimates of Pullout Capacity for Baseline Case

The strength of the soils is an important detail for estimating pullout capacity. The penetration resistance offered by the tent stake during installation provides a rough miscue for the strength of the soil and is based on the average penetration of the stake per blow (for the first 20 inches of embedment) with a 16 lb. sledge hammer using a normal swing. **Table 1** provides a rough relationship between penetration resistance, soil consistency, and pullout capacity for a baseline.

Two important details and cautionary notes about using **Table 1** for estimating capacity are:

- 1) **Table 1** requires a subjective measure (Stake Penetration Resistance) for estimating pullout capacity. More accurate and precise methods are available and given in the IFAI Tent Staking Report. However, the more accurate methods require a greater effort for determining soil strength.
- 2) **Table 1** provides a relationship between driving resistance and baseline stake capacity for the soil conditions **at the time of driving**. If the stake is driven during dry conditions, and then the ground becomes saturated, a loss of soil strength and pullout capacity will result. The loss of soil strength is not possible to predict with confidence without an extensive soil testing or stake pullout testing program. However, results from the IFAI tent staking study indicate that the pullout capacity of stakes driven in saturated ground are about one-half the capacity of the stakes driven in the same ground under dry conditions.

Consistency	Field Identification*		Pullout Capacity for Baseline Case, P (lbs.)
	Soil Resistance	Stake Penetration Resistance (Inches per blow**)	
Hard (Very Dense)	Indented with difficulty by thumbnail	less than 0.2"	2500
Very Stiff (Dense)	Readily indented by thumbnail	0.2-0.5"	1600
Stiff (Medium-Dense)	Readily indented by thumb but penetrated only with great effort	0.5-1.5"	800
Medium (Medium)	Can be penetrated several inches by thumb with moderate effort	1.5-3"	400
Soft (Loose)	Easily penetrated several inches by thumb	3-6"	200
Very Soft (Very Loose)	Easily penetrated several inches by thumb	greater than 6"	100

*Note: Field identification is subjective. For fine-grained soils, use both the verbal description and the inches per blow to select the appropriate consistency of soil to select the baseline capacity. For coarse-grained soils, use the penetration per blow to assess soil consistency.

**Note: Stake Penetration Resistance is based on the average penetration of the stake per blow with a 16 lb. sledge hammer with a normal swing.

Table 1. Simple Method for Estimating Pullout Capacity for Baseline Case.

Adjusting Estimated Capacity for Conditions Different than Baseline Case

The pullout capacity for a stake that is different from the baseline case can be estimated as the baseline capacity multiplied by factors that adjust for the variation in conditions from the baseline (such as a different stake embedment, stake inclination, stake diameter, fastening height, and pull angle). The pullout capacity for the stake can be determined as the baseline capacity, multiplied by the appropriate adjustment factors as follows:

$$P = P_b \times C_e \times C_f \times C_i \times C_l \times C_d < 2500 \text{ lbs.}$$

Where P = pullout capacity for a single stake, P_b = pullout capacity for a standard stake (the baseline case), C_e = correction factor for embedment depth, C_f = correction factor for fastening height, C_i = correction factor for stake inclination, C_l = correction factor for load angle, and C_d = correction factor for stake diameter. The appropriate correction factors can be obtained from the Tables below.

Correction Factor for Embedment	
Stake Embedment (in.)	C_e
36	1.00
34	0.92
32	0.84
30	0.76
28	0.69
26	0.61
24	0.54

Correction Factor for fastening Height	
Fastening Height (in.)	C_f
2	1.00
4	0.98
6	0.96
8	0.94
10	0.92
12	0.90

Correction factor for Stake Inclination	
Stake Inclination	C_i
For stake angle from 0 to 15 degrees	1.00
For stake angle = 30 degrees	0.77

Correction factor for Stake Diameter	
Stake diameter (in.)	C_d
1.000	1.0
1.125	1.1

Correction factor for Load Angle	
Angle of Pull (from horizontal)	C_l
45 degrees (1H:1V)	1.00
53 degrees (2H:3V)	0.85

Group Configuration	Effectiveness Factor
Double Staking	1.22
Three Stakes installed in a line perpendicular to direction of pull	2.76
Three Stakes installed in a line perpendicular to direction of pull are inclined at 15 degrees	2.46
Six Stakes installed in a line perpendicular to direction of pull	4.68
Four Stakes installed in two columns and two rows and connected with a gang plate	3.48
Six Stakes installed in two columns and three rows and connected with a gang plate	4.56

Note: Table 2 requires the stakes in the group to satisfy the conditions set for the baseline case

Table 2. Effectiveness Factor for Group Stakes

Ribbed vs. Smooth Stake

Results of the testing program showed no significant difference in pullout capacity between 1-inch diameter steel stake with smooth sides and a 1-inch steel stake with ribs for most pullout tests. However, structural yielding in the ribbed stakes occurred at pullout loads lower than the smooth steel stakes because of the difference in the structural strength. Accordingly, the pullout capacity of ribbed stakes should be limited to a pullout capacity no greater than 1600 lbs.

Determination of Capacity for Group Stakes

The pullout capacity of group stakes can be estimated by multiplying the baseline capacity of a single stake by an “effectiveness factor” as follows:

$$P_g = P_b \times E_f$$

Where P_g is the capacity of the stake group, P_b is the pullout capacity for a single stake under baseline condition, and E_f is the effectiveness factor for the group of stakes. The effectiveness factors for a group of stakes can be determined using **Table 2**.