

PRODUCT MANUAL



If YOU can IMAGINE it... WE can BUILD it

TIDEWATER SAILCLOTH TENTS

WARNING

This tent product is not intended to be used as a shelter from severe weather. Evacuate immediately if threatening weather occurs (or is forecasted) or any condition arises concerning the safe use of this product. Threatening weather includes electrical storm systems, moderate to high wind (excess of 38mph), heavy rains, snow, or any condition that raises any doubt to the structural integrity of the tent

CAUTION

The installation of electrical, plumbing, lighting, appliances and/or HVAC equipment are not covered within this manual. Users/Installers shall follow local code requirements for the installation of these items using certified personnel. AztecTents shall be indemnified and held harmless from any such use or injury resulting from its use.

Important Safety Information

Proper personnel safety equipment should be worn at all times during the installation of any tenting products.

Hard Hat

Safety Glasses

Work Gloves

Long Pants

Steel Toe Boots

OSHA Approved Harness and restraint system (for off ground activities)



Thank you for your recent purchase from Aztec Tents. The following procedures will help you through your installation. If you ever run into problems with the installation of your Aztec Tent give one of our sales/service professionals a call. Other product specific information, contact information, diagrams, and other operational support is available on our web site at www.aztectent.com.

Contents

General Care & Guidelines	
General Fabric Care & Maintenance	4
General Hardware Care & Maintenance	5
Fabric Flame Retardant Information	5
Anchoring	5-6
Pre-Installation Guidelines	6
General Installation Guidelines	6
Post Installation Guidelines- Maintenance	7
Safety & Evacuation Planning	7
General Take Down/Removal Guidelines	7
Special Care for Unsupported Clear Fabric	8
Other Resources	8
Tools Required for Installation	8
Optional Items & Accessories Available	8
Video Resources	9
Installation Procedure	10-18
Marking using Tape Measures	19-20
King-Queen Layout Diagrams	21
20' (6m) Layout and Squaring Diagrams	22-23
32' (10m) Layout and Squaring Diagrams	24-25
44' (14m) Layout and Squaring Diagrams	26-27
51' (16m) Layout and Squaring Diagrams	28-29
57' (17m) Layout and Squaring Diagrams	30-31
59' (18m) Layout and Squaring Diagrams	32-33
81' (25m) Layout and Squaring Diagrams	34-35
Replacement Parts	36
Parts Images	37
Engineering Specifications	38-40

Questions? Call us.

Aztec Tents

2665 Columbia Street
Torrance, CA 90503 USA
Direct (310) 347-3010
Toll Free (800) 228-3687
Fax (310) 381-0722

V.11282023

General Fabric Care & Maintenance

The vinyl fabric developed for this tent system requires specific attention during installation, cleaning, and storage to maintain its maximum life span. Please follow the following care and maintenance guidelines provided for this product.

GROUND CLOTHS:The usage of ground covering material under the tent during installation and dismantle will protect the tent fabric from soiling and from minor surface abrasions. A ground cloth can also help keep the tent top dry if the ground surface (i.e. dirt, grass, etc.) is wet during the installation or dismantle.

MILDEW TREATMENT:The fabric is pretreated with mildew inhibitors that help prevent the growth and spreading of mildew and fungus. Although treated, proper care should be given to prevent potential growth. If you see mildew wipe it away immediately with a clean towel and diluted soap solution. Never fold your fabric for storage if the fabric is even slightly wet. Mold/Mildew spores in the air and on the ground will come in contact with the fabric while installed. To grow, all the mildew needs is moisture and some source of food (often found in dirt that might be on the tent). Your best bet is to keep your fabric clean and dry to prevent mildew growth.

FABRIC CLEANING:The best way to clean the vinyl tent fabric is with a soft towel or soft bristled brush immersed in a diluted solution of warm water and our tent cleaning solution. A diluted and mixed solution of a tablespoon of traditional dish soap with a gallon of warm water will also work, but extra caution should be placed on insuring that this cleaning solution is thoroughly rinsed from the fabric, especially with clear vinyls (See special notes on working with clear vinyls).

You will need a large, smooth, flat space slightly larger than the section of fabric. This space should be covered with a ground protecting layer to avoid damaging the tent membrane when moving in the washing area. Small impediments, sharp objects and rough surfaces all have the potential to damage the membrane you are trying to clean.

Follow the instructions for the proper dilution ratio of your cleaning product. Apply the diluted solution directly to the fabric using 1) a towel immersed in the solution, or 2) a spray bottle or larger pressurized spraying apparatus to evenly cover the fabric with the solution. Let this sit on the fabric for about one minute to allow the mixture to penetrate the fabric. Using a soft towel or soft bristled polypropylene brush (some can be mounted to a long handle to allow you to stand while working), gently work the cleaner into the fabric using only mild pressure. While harder bristled brushes can work, they will end up microscopically scratching the fabric, potentially permanently damaging the fabric and making it harder to clean the next time. The process of hand cleaning the fabric will allow you to apply only enough diluted solution to get the fabric clean. This will help limit the amount of water placed on the fabric to expedite drying time. Never allow the tent cleaner to dry on the fabric. For this reason, larger tents might be better to clean in sections. Once the cleaning is complete be sure to rinse away any cleaning solution completely from the tent membrane.

Full immersion of the fabric in water is not recommended. The use of commercial front loading or top loading washing machines is not recommended and will void the warranty of the fabric. These machines cause an excessive amount of stress to the fabric and can force water into the fabric causing increased occurrences of mildew growth and shorten the life of the fabric. As with any cleaning, the fabric should be hung to dry completely before folding and storage. Cleaners that include chlorine bleach, and/or any petroleum based solvents will degrade the fabric, discolor the fabric and shorten its life span.

If you have a difficult stain that cannot be removed with traditional cleaning, please consult with your sales person before trying any other chemicals that might end up damaging the material further. Do not use other chemicals or cleaners unless instructed by your sales professional.

FABRIC DRYING:The best way to dry the vinyl tent fabric is to hang-dry in a low humidity environment. Circulating air around the surface of the hanging fabric with the use of fans will also speed the drying process and improve drying time in more humid environments. Please also assure that subassemblies and other components within the tent system are dry before folding. These subassemblies can be reinforcements, lace lines, webbing, rope, thread, and/or any other part that is permanently affixed to the main tent membrane. The use of commercial drying equipment and any drying using heat will void the warranty of the fabric. **DO NOT STORE YOUR FABRIC WET.** Fabric folded and stored wet will mildew.

TENSIONING: Do not over tension your tent fabric during installation, use, or removal. Over tensioning can cause permanent damage to the tent membrane. The most obvious sign of over tensioning would be stress wrinkles at the tension points. Be sure to confirm that your frame/pole components match the tent design. In cases where the ground is not level, over tensioning is possible by trying to force the tent to dimension.

STORAGE RECOMMENDATIONS:The fabric for the tent system shall be stored dry in a cool, dry place in the protective storage bags included with your purchase. Other types of bags are acceptable as long as they can protect the fabric from the environmental elements of the storage area. Optimal storage temperature is between 50°F and 70°F.

INSPECTION: Prior to each use, each component of the tent system needs to be thoroughly inspected to assure its structural stability has not been compromised. Fabric components that are ripped, torn, frayed, or damaged shall be immediately replaced and not used. Structural components of the fabric membrane are the most critical including but not limited to the main fabric membrane, structural reinforcements and webbing, web termination plates/rings/fasteners, and connection points from fabric panel to fabric panel or connection points between the fabric panel and the hardware support system.

General Hardware Care & Maintenance

The hardware components developed for this tent system requires specific attention during installation, cleaning, and storage to maintain its maximum life span. Please follow the following care and maintenance guidelines provided for this product.

OXIDATION: The hardware components for this tent system have been supplied to you with specialty coatings to help limit oxidation. With usage, these coatings will need to be maintained in order to limit oxidation and for the product reach its full intended lifespan. With plated or powder coated steel components, any rust should be removed immediately with a stiff wire brush and sprayed with either a galvanizing spray or durable paint to seal the steel from the elements. Anodized aluminum components will get scratched over time and these scratched areas can develop a thin black oxidation common with mill finish aluminum. This black oxidation can cause staining to any fabric components that come in contact with the pole/component. Your best preventative measure will be to avoid scratching of the anodized coating by avoiding any sharp edges that might be come in contact with the aluminum member.

HARDWARE CLEANING: It is very important to keep your hardware components clean and free of dirt, oxidation, and other chemicals especially if those hardware components come into contact with any fabric components during installation, use, or take-down of your product. Any dirt, oxidation, or chemical on the surface of the hardware member can transfer the contaminant to the fabric causing permanent staining, or permanent damage to the fabric membrane. If hardware components are found to be soiled, wipe down immediately to remove the foreign matter.

STORAGE RECOMMENDATIONS: The hardware for the tent system shall be stored dry in a cool, dry place. Anodized aluminum component can be stored outside, but should be covered to prevent foreign matter from collecting on the components that might stain or damage the fabric membrane during installation or use. Any/all steel components shall be stored indoors in a dry/low humidity environment.

INSPECTION: Prior to and after each use, each component of the tent system needs to be thoroughly inspected to assure its structural stability has not been compromised. Hardware components that are bent, cracked, frayed, or damaged shall be immediately replaced and not used. Specific attention should be paid toward any devices used for anchoring including ratchets, ropes, cables, and web straps.

Fabric Flame Retardancy

All vinyl fabric used in the production of our tents, walls, and accessories are certified flame retardant per per NFPA 701, Canadian CAN-ULC-S109-03, British Standard BS 7837:1996, and are registered with the California State Fire Marshal. These vinyl products are produced so that they are inherently flame retardant, and thus will never require additional applications of flame retardant chemicals.

Every section of fabric produced by AztecTents contains a label identifying its flame resistance characteristics and date produced. This label matches a hard copy of the flame certificate that is mailed to you after receipt of your goods.

If at any time you need to be issued a duplicate flame certificate, you can request one from our customer service representatives. Please be sure to have the invoice number and date of production available when requesting duplicate flame certificates.

Anchoring

All anchoring locations must be laid out accurately as described in the manual and diagrams contained within (in advance of laying out the fabric) to a tolerance of +/- 4" in any direction (right or left, forward or back, up or down, etc.) All column base locations must be laid out to a tolerance of +/- 3" in any direction for any standard supported tents and within a tolerance of +/- .5" for any product utilizing keder channels.

A wide variety of ground anchoring devices are commonly used. Soil conditions and resulting ground anchor holding capacities vary from site to site, and can vary within a particular site. The Owner and/or Installer of the tent is fully responsible for assuring that the selection and installation of the anchoring devices is adequate to resist the pull out loads specified in the product manual.

Reduced anchor performance can occur under wet soil conditions and needs to be accounted for. Care should be taken that water is not allowed to drain or collect near anchors.

Anchoring device holding capacity can be developed using a single large device, or by using multiple smaller devices.

Ensure that the anchors installed are adequate to resist the pull out loads shown. Actual testing of some individual anchors to 75% of the anchor pull-out load is recommended.

Additional installation and anchoring information entitled "The IFAI Procedural Handbook For The Safe Installation And Maintenance Of Tentage" is published by the Tent Rental Division of the Advanced Textiles Association (ATA).

Anchoring Tie Downs

Although we use high quality thread and webbing for all of our sewn tie-down components, ultraviolet light from the sun will slowly breakdown these fibers over time. Chemicals, cleaners, or other products should not be used on webbing tie-down components as its use might accelerate this aging process. Damaged, abraded, cut, or frayed straps should never be used.

Additionally, these straps should never be used for other tie-down applications other than securing the tent for which they were purchased (i.e. securing equipment on a pallet, truck, or trailer). Seasonal installations should replace tie-down straps annually or sooner if any damage is noted. Other straps used in short term applications should be tested periodically to assure that they meet the intended working load for their design. Straps shall expire 5 years from the date of their manufacture (noted on the item tag) and shall not be used.

Pre-Installation Guidelines

Correct field installation of this tent system requires diligence and considerable skill and expertise which can be obtained only through the proper field training and experience of a professional rental tent supervised installation crew. This is instrumental to obtaining the optimal structural behavior of the tent.

- Obtain any required permits or inspections needed by local codes and regulations.
- Clear the site to prepare for the planned activity.
- Check for sub grade utilities before installing any anchoring devices.
- Check for any overhead obstructions that might interfere with the tent installation. Do not install any tent within 50' of any overhead utilities, power lines, or other obstructions. Installation under or within close proximity to trees should be avoided.
- Locate the public circulation routes with clearance from anchors around the exterior of the site. Identify clearly.
- Use drop cloths to prevent soiling or damaging the fabric membrane.
- Pad and tape objects with sharp projections which will remain on site under the tent.
- Cover any sharp edges on anchoring devices with protective material

General Installation Guidelines

Each component of the tent should be inspected at the beginning of installation for visual signs of damage by the installer. All damaged materials should be repaired or replaced immediately.

The weather should be carefully considered by the Owner and/or the Installer before raising the tent since the hardware and fabric cannot transmit design wind loads or shed rainwater loads (potential ponding) when it is not fully anchored, installed, and/or tensioned. It is recommended that installation or removal of the fabric members be performed when the wind speed is less than 15 mph. The decision to raise or lower the fabric of the tent should be the responsibility of the experienced rental tent installation supervisor based upon conservative life safety considerations and judgement.

Adequate and appropriate installation and maintenance procedures are necessary to achieve and sustain full design load capability for the tent. The Owner and/or Installer are fully responsible for assuring that the tent is properly installed and maintained.

Certification of this tent structure is valid only with the use of Aztec Tent supplied and assured components or those which meet or exceed the requirements of the design throughout the installation of this structure, with the exception of the anchoring devices which must be determined by the installation engineer.

Post Installation Guidelines / Maintenance

Each component of the tent should be inspected at the end of installation for visual signs of damage by the installer. Additionally, an inspection should be performed after any severe weather/wind events that might have affected the overall integrity of the design. All damaged materials should be repaired or replaced immediately.

A variety of material and weather factors can result in fabric stretch, web belt stretch, rope stretch, mast base settling, changes to design geometry, etc. Changes to the design geometry of the tent and consequently the structural performance characteristics of the tent, can occur while the tent is in service and not attended by the professional installer. It is recommended that a maintenance agreement be arranged between the Client/User of the tent and the Installer involving periodic inspections and adjustments.

If rainwater ponding occurs at any point on the fabric, evacuate the tent, remove the water, and adjust the tie back rope/web prestress tension and/or fabric tensioning over the frame back to its design geometry to achieve positive drainage.

It is understood and expected that some damage to the fabric membrane and/or non structural components may occur in conditions below the overall design wind velocity rating of the tent system. This damage may result in components requiring repair or replacement as necessary.

Safety & Evacuation Planning

It is the responsibility of the Owner and/or the Installer to warn the User and or Occupants of the tent system that this product is not intended to be used as a shelter from severe weather. Aztec assumes no liability for such use. An evacuation and communication plan for the area covered within this tented space is imperative and shall be thoroughly communicated to all users and potential occupants of the tent. Severe weather including electrical storm systems, moderate to severe wind, heavy rains, snow, or any condition that raises any doubt to the structural integrity of the tent are immediate signs that an evacuation is necessary. Severe bodily injury and/or death can occur. A best practices document published by the American Rental Association covering this topic can be downloaded at: http://aztectent.com/webfm_send/151

Common signs that warrant the immediate evacuation of this tent:

- Any movement, displacement, or failure of any of the anchoring devices or support hardware.
- Any component failure in part or whole
- Any tear or puncture in the fabric membrane
- Any forecasted moderate to severe weather condition
- Any collection or accumulation of snow or ice on the tent
- Strong winds causing movement and/shifting of the tent or tent support structure
- Strong winds causing small branches to be ripped from trees
- Any lightning or electrical storms
- Hail or frozen precipitation any larger than pea size
- Any fire or smoke within close proximity of the tent
- Any smell of gas, exhaust, or other odor from any combustible material

In the event of forecasted severe weather, hurricane, or other such early warning, it is recommended to immediately evacuate the tent and time permitting take down the tent and remove from the site.

General Take Down / Removal Guidelines

The weather should be carefully considered by the Owner and/or the Installer before lowering the tent since the hardware and fabric cannot transmit design wind loads or shed rainwater loads (potential ponding) when it is not fully anchored, installed, and/or tensioned. It is recommended that installation or removal of the fabric members be performed when the wind speed is less than 15 mph. The decision to raise or lower the fabric of the tent should be the responsibility of the experienced rental tent installation supervisor based upon conservative life safety considerations and judgement.

Unless otherwise noted in the procedures that follow, the removal of this tent system shall follow the same procedures outlined but in the reverse order.

Once unassembled, each component of the system should be inspected for any signs of visual damage by the installer. All damaged materials should be marked or identified so that repair or replacement of these materials can occur prior to the next use of the product.

Special Care For Unsupported Clear Fabric

The clear fabric used in window style sidewalls, clear sidewalls, and clear tent tops needs to be managed differently than standard tent fabric. Polyester scrim is what gives standard tent fabric its strength, stability and durability. Laminated tent fabric enjoys the benefit of encasing this woven layer of rip-stop polyester between the layers of colored vinyl film. Clear vinyl does not enjoy those benefits. Because of this, clear vinyl has a very low tolerance to ultra violet ray exposure, wind, airborne particulate matter, hot or cold temperatures, elasticity due to wind and rain and handling. Any or all of these factors will cause clear fabric to under perform when compared to traditional tent fabric.

Exposure to ultra violet rays for an extended amount of time as will occur with time over the life of the product, will cause the fabric to appear milky or opaque. Putting away and storing damp or wet clear vinyl will result in a foggy hue in the clear film. Usually, this fogginess will disappear when the walls are left open to dry and warm up. Steady wind can whip clear vinyl back and forth and cause surface or through cracks in the fabric. Heat in excess of 85°F will cause clear vinyl to stretch and distort. Although our clear vinyl has a cold crack rating of near freezing, that rating is for a static environment. Any introduction of wind or manipulation by handling will cause failure (cracking like glass) in colder conditions. Use of clear fabric in temperatures less than 50°F should be avoided. Airborne particulate matter will abrade the surface and cause the finish to become less translucent.

Clear tent tops are also very susceptible to water ponding as they are highly elastic. If rain is forecasted during the use of these products it is recommended to take additional precautions and more frequent inspections throughout the duration of the rainfall to inspect for potential ponding on the roof fabric. If rainwater ponding occurs at any point on the fabric, evacuate the tent, remove the water, and adjust the tie back rope/web prestress tension and/or fabric tensioning over the frame back to its design geometry to achieve positive drainage.

Special attention should be paid to the cleaning of these items. Use only the softest towels when cleaning the clear membrane to avoid scratching the highly polished surface, and wipe dry to avoid water spots. Use standard diluted tent cleaning solution. **DO NOT USE OTHER CHEMICALS.** Optimal storage temperature is between 50°F and 70°F.

Other Resources

American Rental Association- www.ararental.org
Tent Rental Division of the Advanced Textiles Association

Tools Required for Installation

Sledge Hammer	For driving anchoring stakes
Canopy Jacks	For lifting Frame
Drop Cloths	For protecting fabric membrane
Pull Ropes	For pulling fabric membrane over roof
8' Ladder	General installation tool
Utility Knife	General installation tool
Tape Measure	General installation tool
Marking Paint/Chalk	Used to mark anchoring locations and tent boundaries

Optional Items & Accessories Available

JT Keder Feeder Set	Assists in feeding membrane panels into the keder track beams
Side Wall Panels	To enclose walls of tent
Raingutters	To collect and divert water away from connecting tent entrances
Decorative Liners	To add decorative look and hide most rafter framework
Double Valance	Makes installation of traditional sidewall and gutters easier
Canopy Doors	To add easily accessible means of egress to and from the tent
JT Wall Tension Bars	To secure the bottoms of the walls from moving in breezy conditions
Additional Anchors	Additional anchors used to secure the tent system

Relevant Video Resources

Our website is the primary collection point for video resources for our different products. Visit www.aztectent.com and select "Videos" for a current collection of installation and maintenance videos.

These videos include:

- Marketing Videos
- Jig usage video
- Tent squaring
- Tidewater flag installation
- Tent lacing
- Jump rope tying
- Sidewall installation
- Tidewater Wave marquee
- Complete 44x83 installation

Installation Procedure:

Step 1:

Layout and mark the terminating points for the legs, center poles and anchoring. Anchoring points shall be placed at a distance equal to twelve (12") inches less than the leg height and in line of pull that falls directly in line with the corresponding center pole and corresponding leg.

If you are using the tape measure version instead of the jig method, see page 18 for instructions.

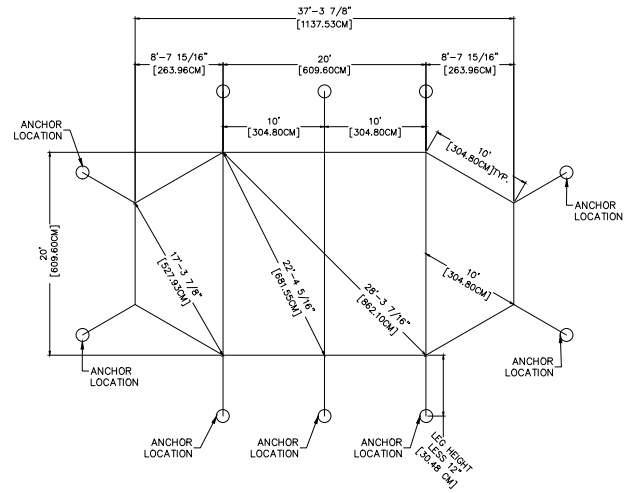

Step 2:

With 2 tape measures, establish the interior box, square with diagonal measurement establishing the four corner side pole positions. For this example we'll designate the two corner side poles on the left side of the drawing as SP-A and SP-B

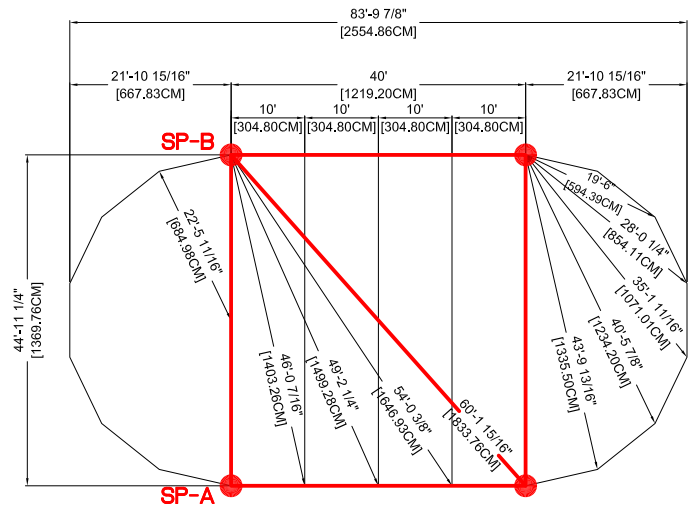

Step 3:

TIDEWATER JIG METHOD

Layout your Tidewater Squaring Jig so that the Side Pole Marker 1 ring is placed on SP-A and the Side Pole Marker 2 ring is on SP-B. Extend the stake line ring in line with the SP-A and SP-B. Make a mark at SP-A, the Center Pole, SP-B and the Stake.

Please Note - Stake cable on the Jig is set for 7' side poles. Adjust accordingly.

If you do not have a jig, review tape measure method starting page 18

(In this example the width is 44' 11 1/4" , the center pole is located at 22' 5 5/8" between side pole positions 1 and 2)

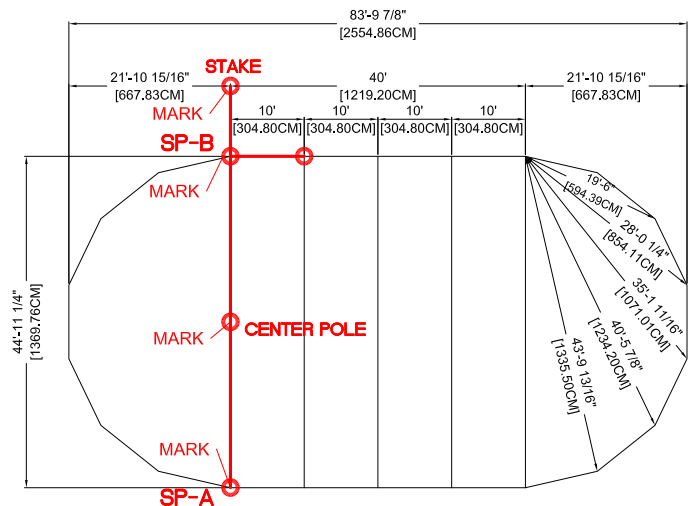

Step 4:

Hold the Center Pole ring in place and move the squaring jig so that the Side Pole Marker 3 ring is positioned over the mark at SP-B. With the Center Pole Ring and Side Pole Marker 3 ring firmly secured, pull on the Side Pole Marker 2 ring to triangulate the next side pole position. Pull the stake line out so that it is in line with the Center Pole and Side Pole Marker 2 rings and mark the stake and side pole positions.

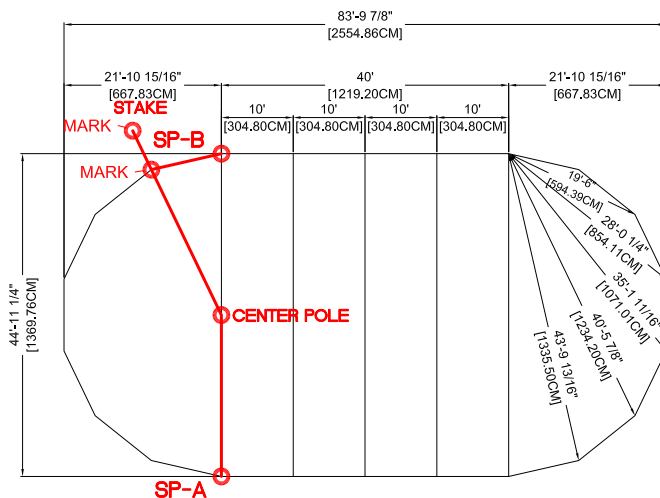

Step 5:

Continue around the end marking each side pole and stake location. Repeat on the opposite end of the tent.

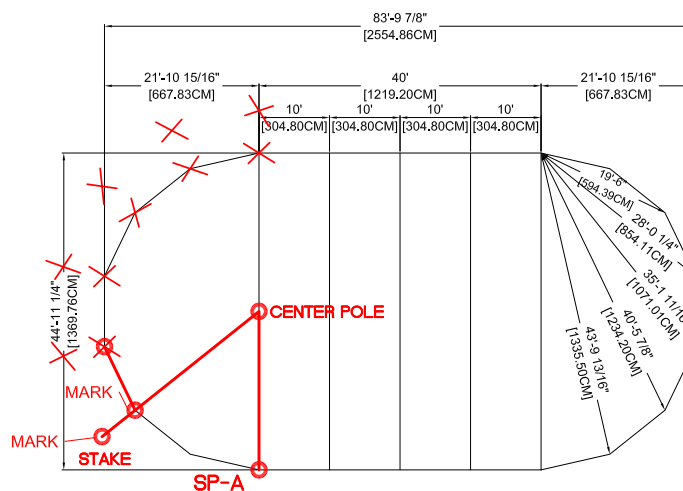

Step 6:

Lay out a ground cloth over the area to be covered by the tent. Unfold the tent top fabric over the ground cloth with the reinforcement side facing down.

For a one piece top, insert the Tidewater flagpole while tent is half opened.

Stretch out the balance of the fabric and pull the perimeter termination plates to the leg points you have marked in steps 1-5.

If one piece top, skip to step 18.



Step 7:
When opening the sections, make sure the lace line tags match up Q to Q or K to K.



Step 8:
With tent top on ground cover, attach the hook at the side pole and pull the center pole rings together. All work should be done from between the sections and not on top of them to avoid damage to the top.



Step 9:
Insert the Tidewater flagpole up through the lace section ring, then through the grommet section.



Step 10:
Attach the Tidewater Flag. Unwrap the flag from the pole.



Step 11:
Insert the first lace up through the first grommet.

On the twin pole tents, the center section laces from one pole to the other one. Make sure you start at the end opposite the long lace near the center pole, lace from pole to pole then down the side.



Step 12:
Insert the second lace up through the second grommet, then through the loop of the first lace.



Step 13:
Pull the second lace through the first lace.



Step 14:
Pull down toward the third grommet.



Step 15:
Repeat inserting the lace up through the grommets then through the previous lace, pulling the sections together.

Hint:
Since the fabric panels are not flat, there will be gaps between the 2 sections. To make it easier to lace, occasionally grab a completed lace and pull the sections toward the center pole. This will help close up the next section of laces. Make sure not to step on the vinyl.



Step 16:
When you reach the side pole, the second to last, long lace goes through the last lace.



Step 17:
Tie the long lace to itself using a half hitch.



Step 18:
Using shoe covers or stocking feet, walk back to the top of the tent. Lay the section flat and begin attaching the Velcro sandwich sections. Continue down the tent, keeping the sections flat and the Velcro neat and flat.



Step 19:

Distribute the side poles, stakes and tie downs around the tent near the marked locations.

Center poles should be placed with the top near the edge of the tent in the directions installer determines is the best angle. Best angle to install the first center pole needs to be determined based on winds, length of tent, and site layout.

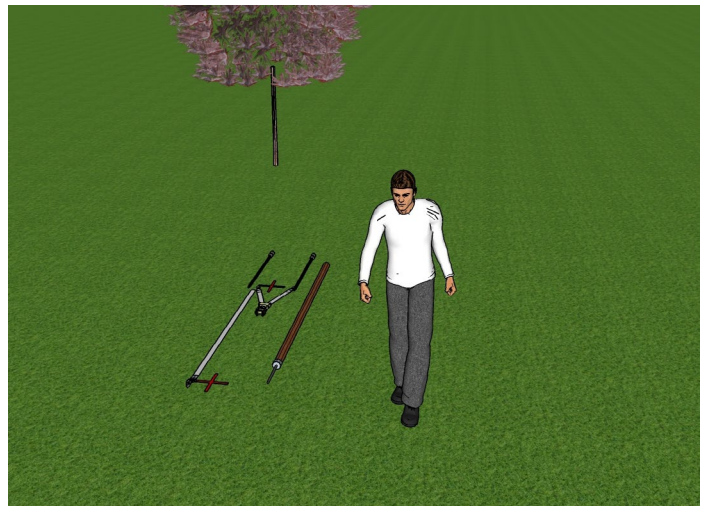

Step 20:

Place the stake through the ring end of the In-Line ratchet and drive at the marked location until 2" or less of the stake is showing below the head. Depending on your soil conditions you might require additional stakes and ratchets to sufficiently anchor the tent. On larger models (44x and larger) which are supplied with double yoke ratchets, both rings can be attached to a single stake or separated to two different stakes.

NOTICE

The anchoring devices included with the purchase of this tent will not be suitable for every application or ground condition. It is the installer's responsibility to confirm that the anchoring devices used will support the recommended resistance load requirements specified in the appendix of this manual. Additional or different types of anchors may be needed depending on ground conditions.



Step 21:

Starting at a round end, insert the first side pole into the perimeter plate fitting/reinforcement around the perimeter of the tent top. Erect side pole and leave just short of vertical. Apply just enough tension to keep the pole in position. Using the Tidewater Install Straps, attach these to the plate and to the next stake on both sides of the first pole to create a "V". This keeps the tent from rotating while the rest of the poles are installed.



Step 22:

Continue installing the side poles around the rest of the tent, using the second Tidewater Install Strap on opposite end of the tent if necessary.



Step 23:

Assemble and erect the center pole(s).

From underneath the tent insert the tip (pin) of the centerpole through the ring at the peak and push the fabric toward the sky until the centerpole is vertical and the bottom of the pole is positioned on the mark made in Step 4. You may have to raise the pole in two steps as you need to install the next pole before the ring gets too high off the ground.

Best angle to install the first center pole needs to be determined based on winds, length of tent, and site layout. Other poles should be installed from raised pole toward tent still on the ground.



Step 24:

Straighten the sidepoles around the tent using the ratchet straps so that they are vertical and plum. Use the ratchet tensioners to pull the tent top tight. Be careful to not over tension one side of the tent as it will pull the opposite side out of vertical alignment. You will need to reset the ratchet as you tension it to avoid too much webbing on the ratchet spindle.



Step 25:

Tie off the jumper ropes. Connected to each reinforcement fitting at the leg pole position and peak positions is a 1/4" Polypropylene rope that should be tied to the poles to prevent the top from lifting off the poles during windy conditions.

Note: This may need to be done in Step 22 if the wind threatens to lift the top off the side poles before the center poles are installed.



Step 26:

Install any sidewall needed by clipping the top hooks of the wall to the rope-line just under the eave of the tent.



Consider some Tidewater accessories like the Tidewater Wave Marquee



Tidewater Squaring: Tape Measure Version

Step 1:
The Squaring Diagram (Example 44'x83')

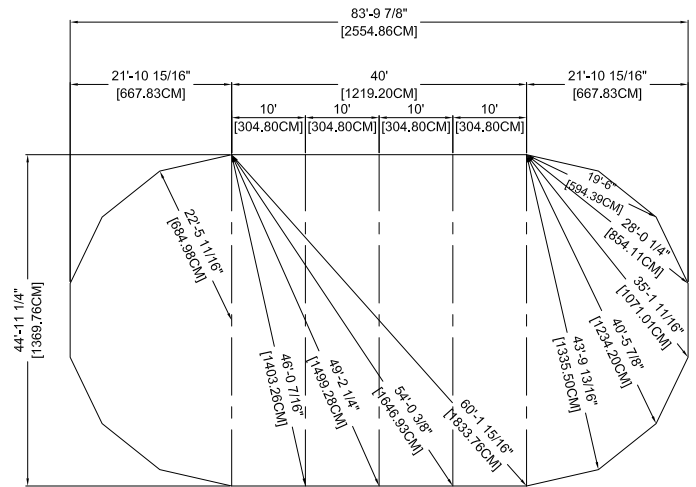

Step 2:
With 2 tape measures, establish the interior box, square with diagonal measurement establishing the four corner side pole positions.

For this example we'll designate the two corner side poles on the left side of the drawing as SP-A and SP-B

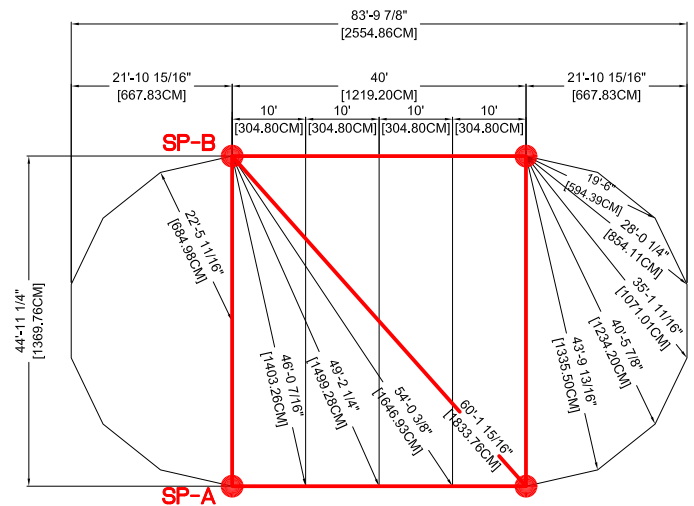

Step 3:
Mark the center pole locations.
The center poles are located 1/2 the distance of the width of the tent.

(In this example the width is 44' 11 1/4" , the center pole is located at 22' 5 5/8" between side pole positions 1 and 2)

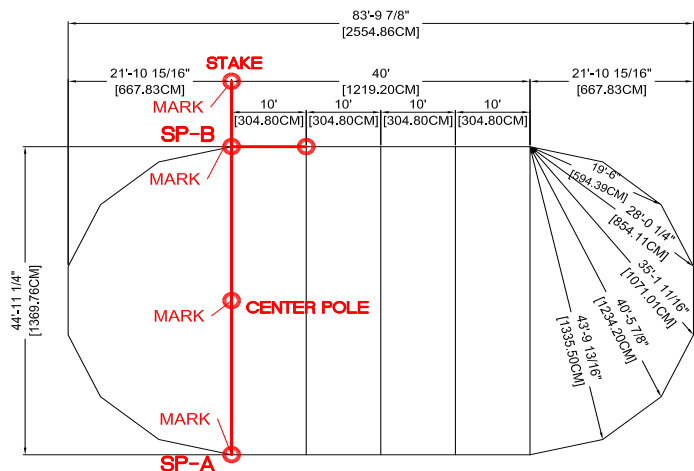

Step 4:

Triangulate the "round end" side pole locations. The distance from the center pole to each side pole on the "round end" is constant. (On the 44x83 example shown, the distance is 22' 5 5/8") Anchor the end of one tape measure at "CP" and the end of a second tape measure at "A". For the Measurement of side pole "B" you triangulate 22' 5 5/8" on the "CP" tape measure with 10' on the "A" tape measure.

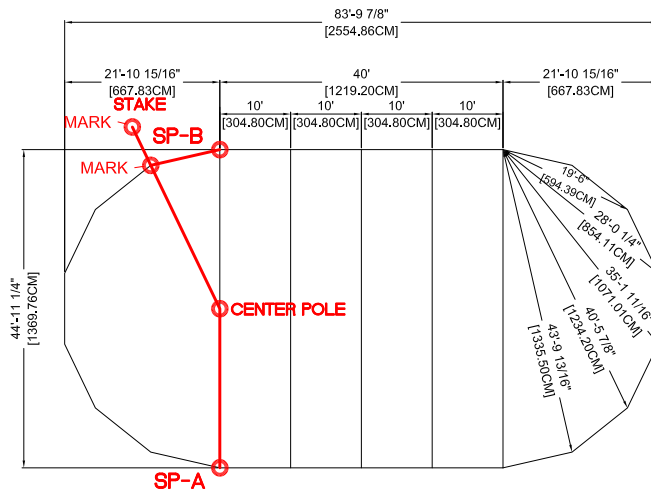

Step 5:

Triangulate the "round end" side pole locations (continued). For the Measurement of side pole "C" you triangulate 22' 5 5/8" on the "CP" tape measure with 19' 6" on the "A" tape measure. Continue the triangulated measurements through side pole "G" and then follow the same steps on the opposing "round end"

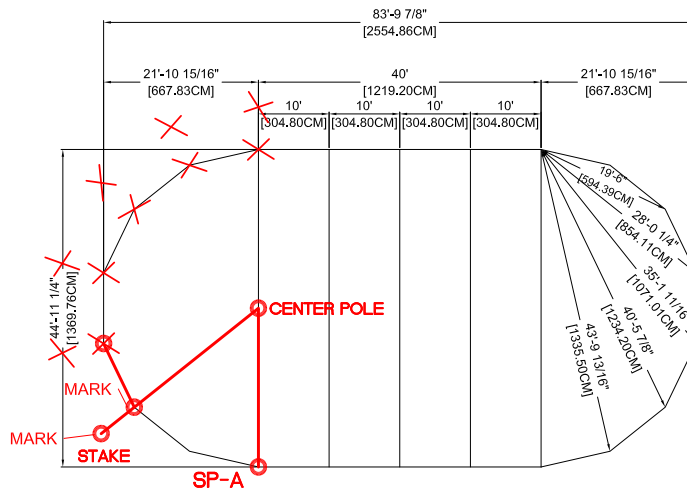

KING-QUEEN LAYOUTS

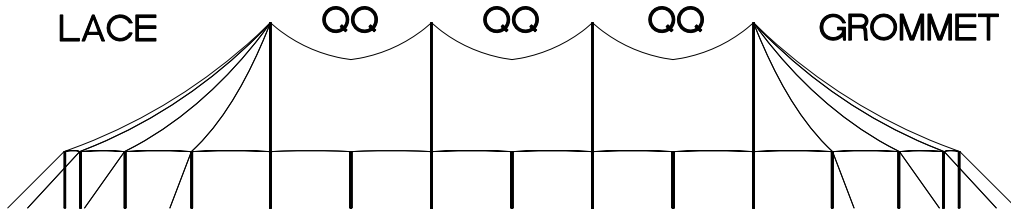
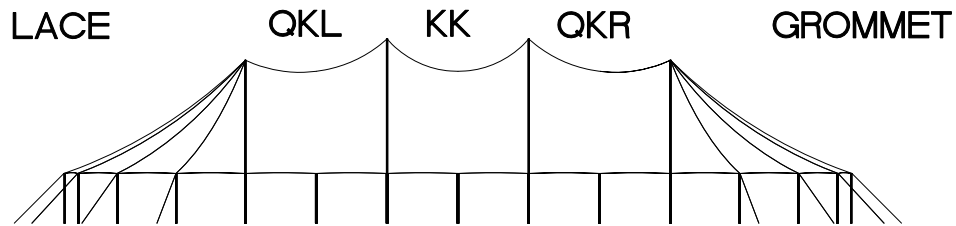
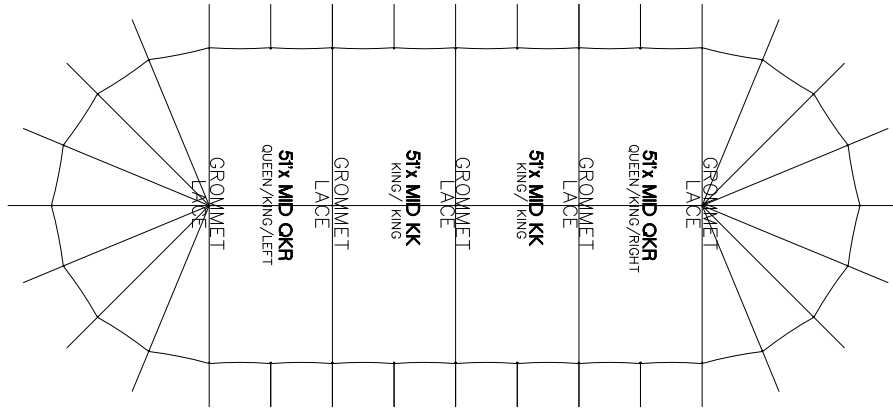

REVISION HISTORY			
REV.	DESCRIPTION	BY:	DATE:

CONFIDENTIAL

ENGINEER: N/A	DATE: 4/26/2017
PAGE: 1 OF 1	DRAWN: LYZ

TIDEWATER POLE TENT

TIDEWATER SAILCLOTH TENT
51'W X 111'L

PART NUMBER: ZXXXXXXX

DESIGN & PRODUCTION

2665 COLUMBIA ST. TORRANCE, CA. 90503
(800) 228-3687 - FAX (310) 381-0722

ALL DATA AND INFORMATION CONTAINED IN OR DISCLOSED BY THIS DOCUMENT IS CONFIDENTIAL AND PROPRIETARY INFORMATION OF AZTEC TENTS AND ALL RIGHTS THEREIN ARE EXPRESSLY RESERVED. BY ACCEPTING THIS MATERIAL THE RECIPIENT AGREES THAT THIS MATERIAL AND INFORMATION CONTAINED THEREIN IS HELD IN CONFIDENCE AND IN TRUST AND WILL NOT BE COPIED, REPRODUCED WHOLE OR IN PART, NOR ITS CONTENTS REVEALED IN ANY MANOR TO OTHERS, EXCEPT TO MEET THE SPECIFIC PURPOSE FOR WHICH IT WAS DELIVERED.

20' (6M) TIDEWATER

20'W X 17'L (6M x 5M)

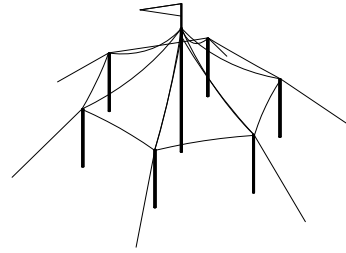
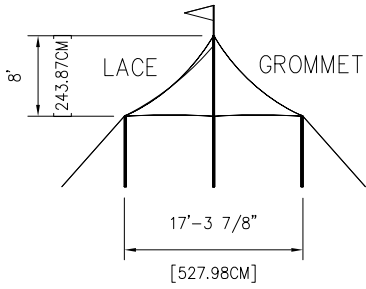

20'W X 27'L (6M x 8M)

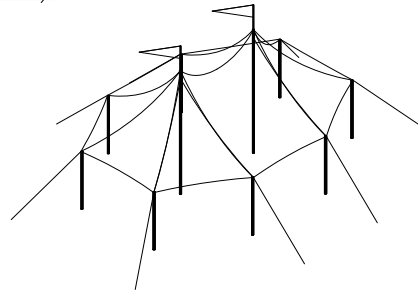
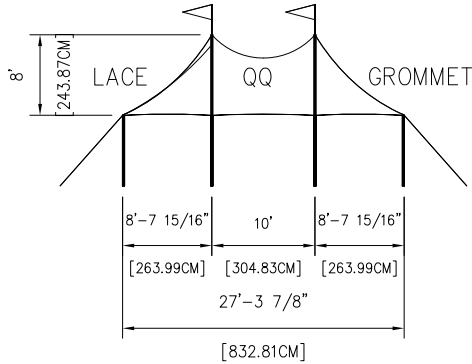

20'W X 37'L (6M x 11M)

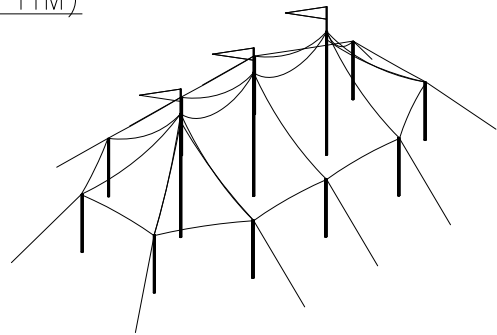
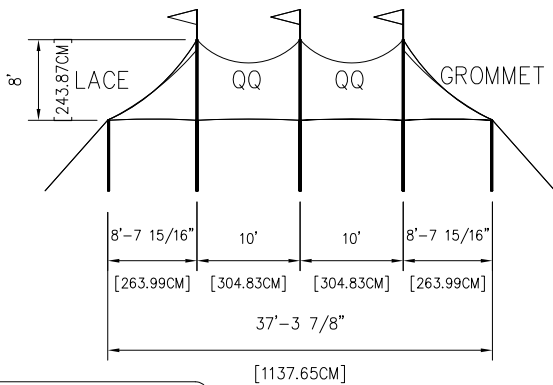

REVISION HISTORY			
REV.	DESCRIPTION	BY:	DATE:

CONFIDENTIAL

ENGINEER:	N/A	DATE:	5/1/2017
PAGE:	1 OF 1	DRAWN:	LYZ

TIDEWATER POLE TENT
 20'W(6.096M) TIDEWATER
 PART NUMBER: ZXXXXXX

AZTEC TENTS
 DESIGN & PRODUCTION
 2665 COLUMBIA ST. TORRANCE, CA. 90503
 (800) 228-3687 - FAX (310) 381-0722

ALL DATA AND INFORMATION CONTAINED IN OR DISCLOSED BY THIS DOCUMENT IS CONFIDENTIAL AND PROPRIETARY INFORMATION OF AZTEC TENTS AND ALL RIGHTS THEREIN ARE EXPRESSLY RESERVED. BY ACCEPTING THIS MATERIAL THE RECIPIENT AGREES THAT THIS MATERIAL AND INFORMATION CONTAINED THEREIN IS HELD IN CONFIDENCE AND IN TRUST AND WILL NOT BE COPIED, REPRODUCED WHOLE OR IN PART, NOR ITS CONTENTS REVEALED IN ANY MANNER TO OTHERS, EXCEPT TO MEET THE SPECIFIC PURPOSE FOR WHICH IT WAS DELIVERED.

20'W x 37'L (6M x 11M) TIDEWATER SQUARING

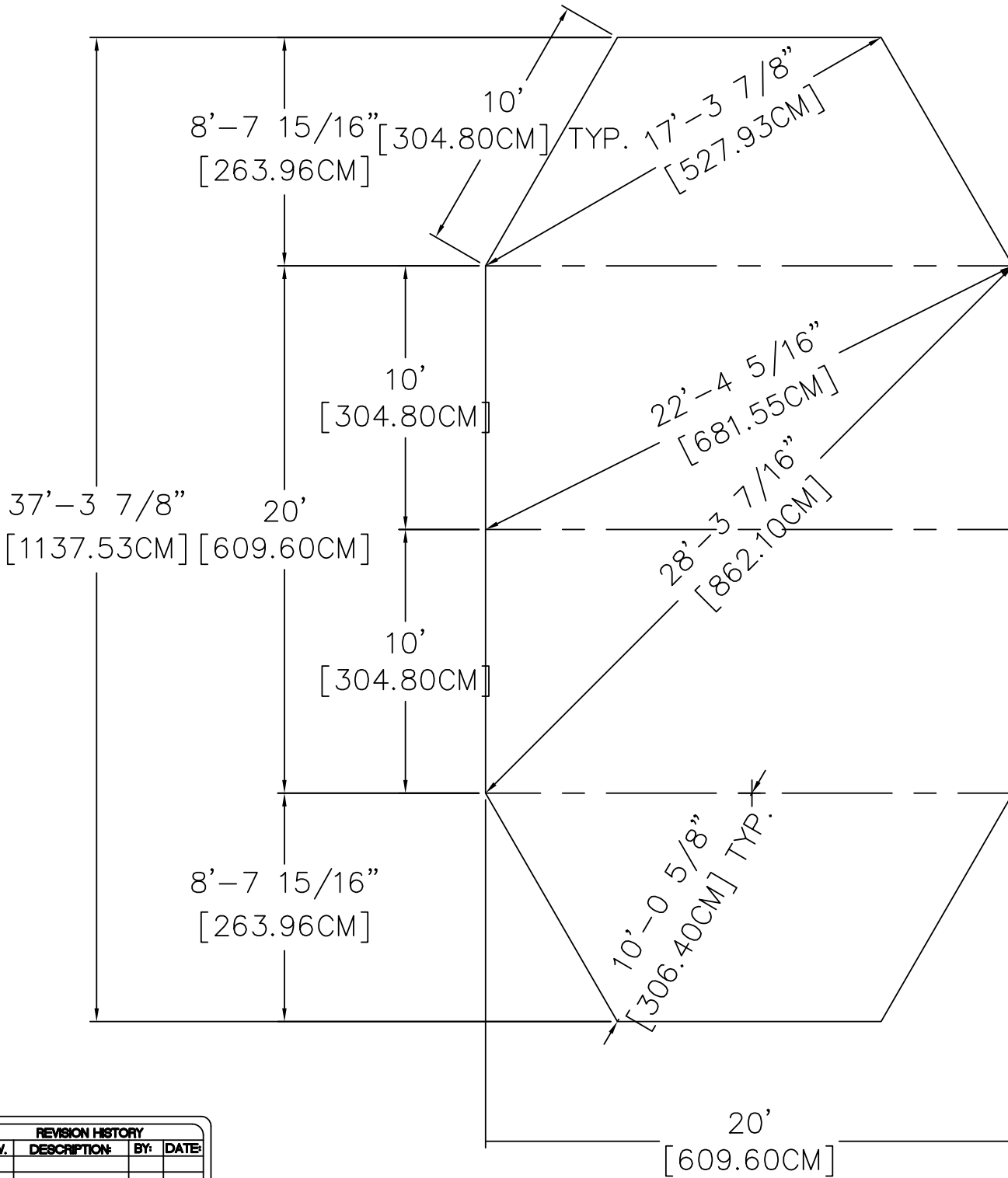

REVISION HISTORY			
REV.	DESCRIPTION	BY:	DATE:

CONFIDENTIAL

ENGINEER: N/A DATE: 5/22/2017
 PAGES: 1 OF 1 DRAWN: LYZ R.

TIDEWATER FRAME

TIDEWATER SAILCLOTH TENT SQUARING
 20'W X 37'L (6.096M X 11.375M)

PART NUMBER: ZXXXXXX



DESIGN & PRODUCTION
 2665 COLUMBIA ST. TORRANCE, CA. 90503
 (800) 228-3687 - FAX (310) 381-0722

ALL DATA AND INFORMATION CONTAINED IN OR DISCLOSED BY THIS DOCUMENT IS CONFIDENTIAL AND PROPRIETARY INFORMATION OF AZTEC TENTS AND ALL RIGHTS THEREIN ARE EXPRESSLY RESERVED. BY ACCEPTING THIS MATERIAL THE RECIPIENT AGREES THAT THIS MATERIAL AND INFORMATION CONTAINED THEREIN IS HELD IN CONFIDENCE AND IN TRUST AND WILL NOT BE COPIED, REPRODUCED WHOLE OR IN PART, NOR ITS CONTENTS REVEALED IN ANY MANNER TO OTHERS, EXCEPT TO MEET THE SPECIFIC PURPOSE FOR WHICH IT WAS DELIVERED.

32' (10M) TIDEWATER

32'W x 30'L (10M x 9M)

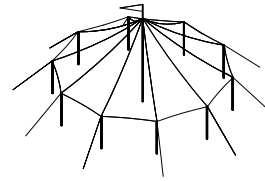
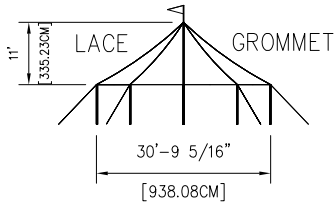

32'W x 40'L (10M x 12M)

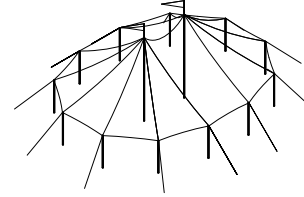
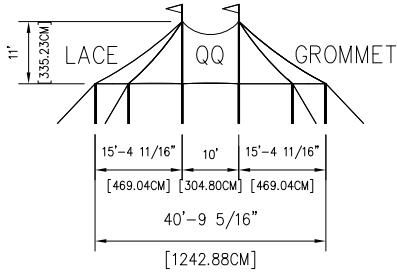

32'W x 50'L (10M x 15M)

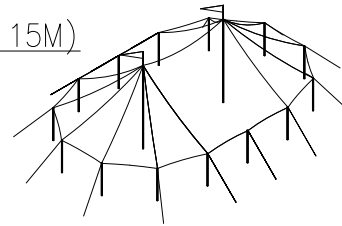
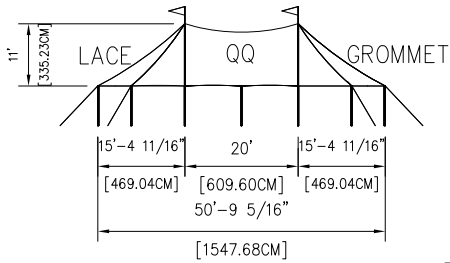

32'W x 70'L (10M x 21M)

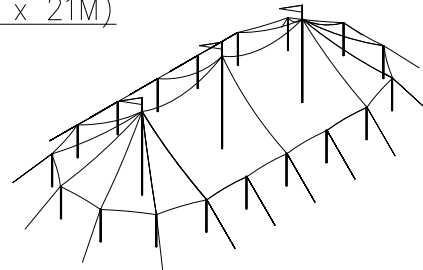
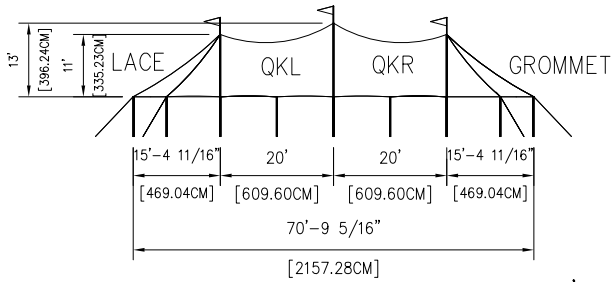

32'W x 90'L (10M x 27M)

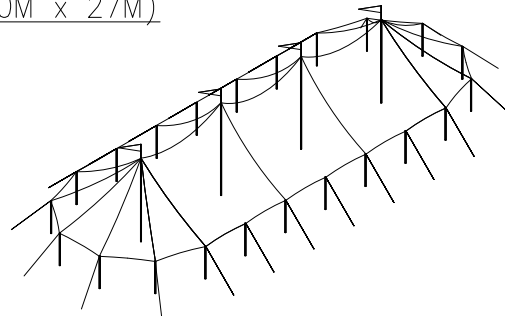
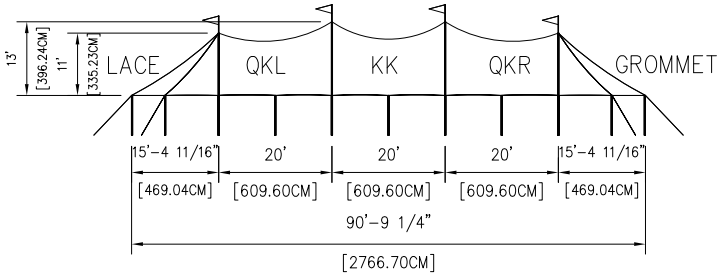

REVISION HISTORY

REV.	DESCRIPTION	BY:	DATE:

CONFIDENTIAL

ENGINEER: N/A DATE: 5/1/2017
 PAGE: 1 OF 1 DRAWN: LYZ

TIDEWATER POLE TENT

32'W(9.854M) TIDEWATER

PART NUMBER: ZXXXXXX



DESIGN & PRODUCTION
 2665 COLUMBIA ST. TORRANCE, CA. 90503
 (800) 228-3687 - FAX (310) 381-0722

ALL DATA AND INFORMATION CONTAINED IN OR DISCLOSED BY THIS DOCUMENT IS CONFIDENTIAL AND PROPRIETARY INFORMATION OF AZTEC TENTS AND ALL RIGHTS THEREIN ARE EXPRESSLY RESERVED. BY ACCEPTING THIS MATERIAL THE RECIPIENT AGREES THAT THIS MATERIAL AND INFORMATION CONTAINED THEREIN IS HELD IN CONFIDENCE AND IN TRUST AND WILL NOT BE COPIED, REPRODUCED WHOLE OR IN PART, NOR ITS CONTENTS REVEALED IN ANY MANNER TO OTHERS, EXCEPT TO MEET THE SPECIFIC PURPOSE FOR WHICH IT WAS DELIVERED.

32'W (10M) SQUARING DIAGRAM

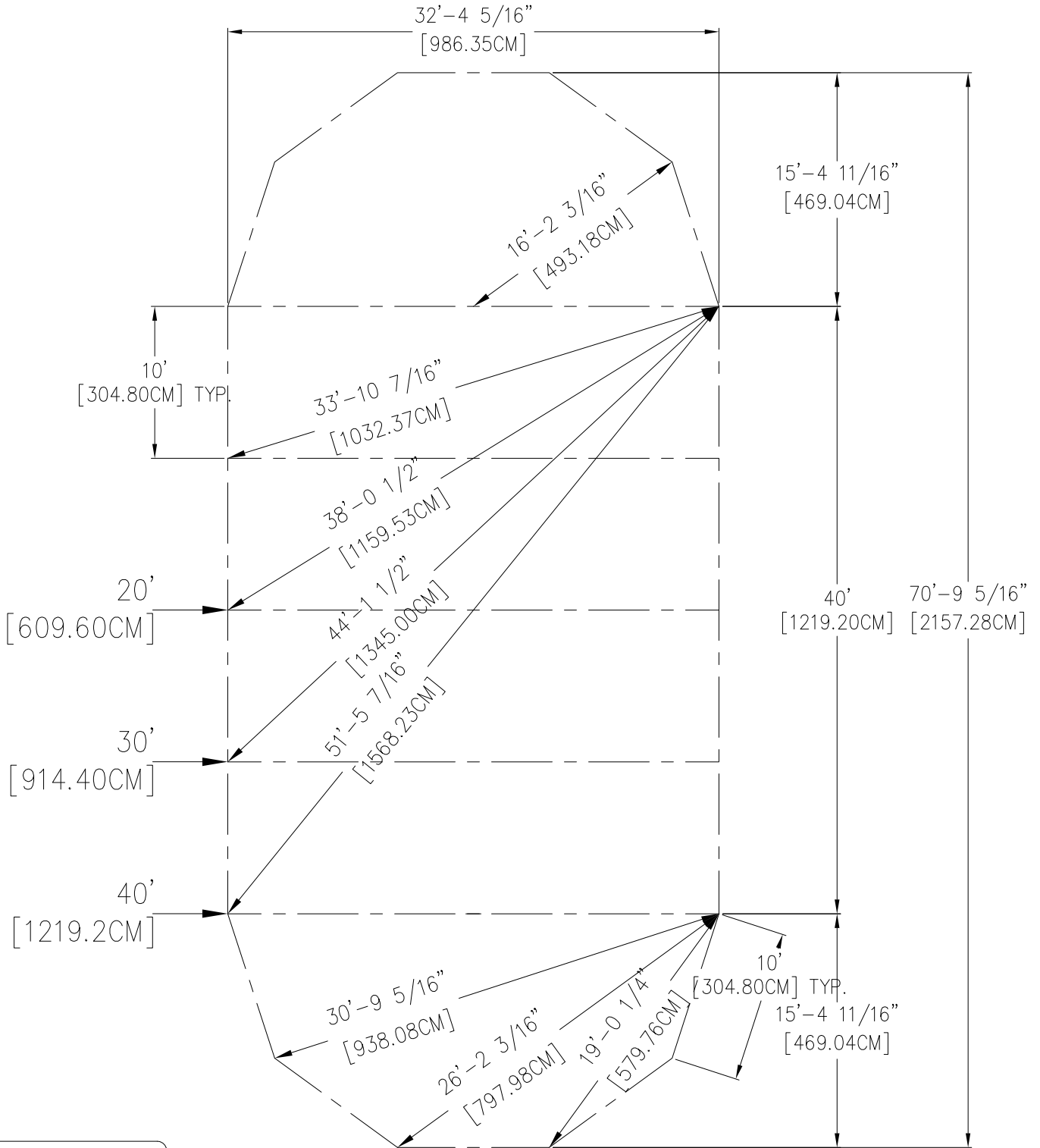

REVISION HISTORY			
REV.	DESCRIPTION	BY:	DATE:

CONFIDENTIAL

ENGINEER: N/A DATE: 6/8/2017
 PAGE: 1 OF 1 DRAWN: LYZ

TIDEWATER FRAME

TIDEWATER SAILCLOTH TENT SQUARING
 32'W x 70'L (9.864M x 21.573M)

PART NUMBER: ZXXXXXXX

AZTEC TENTS

DESIGN & PRODUCTION
 2665 COLUMBIA ST. TORRANCE, CA. 90503
 (800) 228-3687 - FAX (310) 381-0722

ALL DATA AND INFORMATION CONTAINED IN OR DISCLOSED BY THIS DOCUMENT IS CONFIDENTIAL AND PROPRIETARY INFORMATION OF AZTEC TENTS AND ALL RIGHTS THEREIN ARE EXPRESSLY RESERVED. BY ACCEPTING THIS MATERIAL THE RECIPIENT AGREES THAT THIS MATERIAL AND INFORMATION CONTAINED THEREIN IS HELD IN CONFIDENCE AND IN TRUST AND WILL NOT BE COPIED, REPRODUCED WHOLE OR IN PART, NOR ITS CONTENTS REVEALED IN ANY MANNER TO OTHERS, EXCEPT TO MEET THE SPECIFIC PURPOSE FOR WHICH IT WAS DELIVERED.

44' (14M) TIDEWATER

44'W x 43'L (14M x 13M)

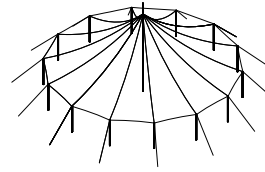
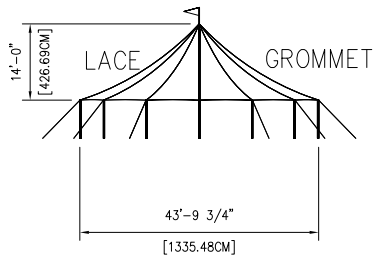

44'W x 63'L (14M x 19M)

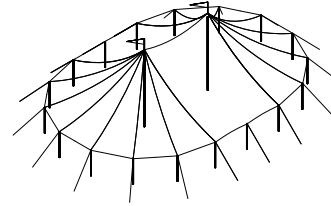
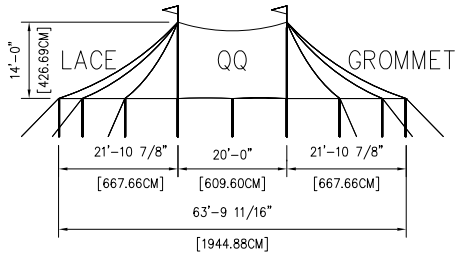

44'W x 83'L (14M x 25M)

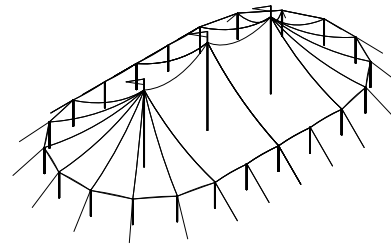
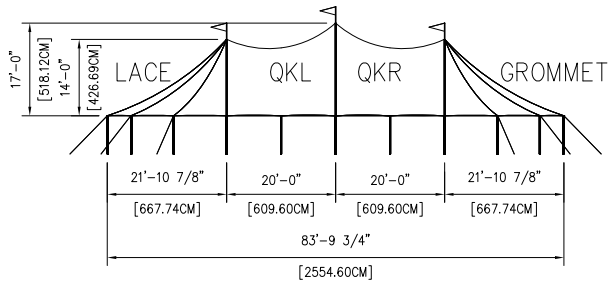

44'W x 103'L (14M x 31M)

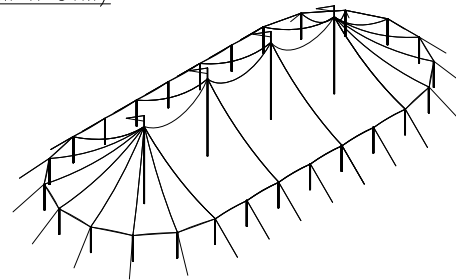
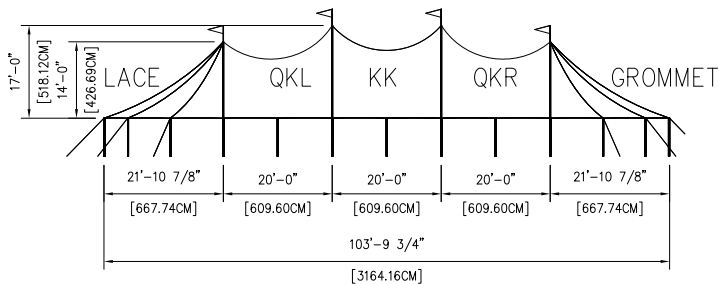

REVISION HISTORY

REV.	DESCRIPTION	BY:	DATE:

CONFIDENTIAL

ENGINEER: N/A DATE: 4/24/2017
 PAGE: 1 OF 1 DRAWN: LYZ

TIDEWATER SAIL TENT

44'W(13.697M) TIDEWATER

PART NUMBER: ZXXXXXX



DESIGN & PRODUCTION
 2665 COLUMBIA ST. TORRANCE, CA. 90503
 (800) 228-3687 - FAX (310) 381-0722

ALL DATA AND INFORMATION CONTAINED IN OR DISCLOSED BY THIS DOCUMENT IS CONFIDENTIAL AND PROPRIETARY INFORMATION OF AZTEC TENTS AND ALL RIGHTS THEREIN ARE EXPRESSLY RESERVED. BY ACCEPTING THIS MATERIAL THE RECIPIENT AGREES THAT THIS MATERIAL AND INFORMATION CONTAINED THEREIN IS HELD IN CONFIDENCE AND IN TRUST AND WILL NOT BE COPIED, REPRODUCED WHOLE OR IN PART, NOR ITS CONTENTS REVEALED IN ANY MANNER TO OTHERS, EXCEPT TO MEET THE SPECIFIC PURPOSE FOR WHICH IT WAS DELIVERED.

44'W (14M) SQUARING DIAGRAM

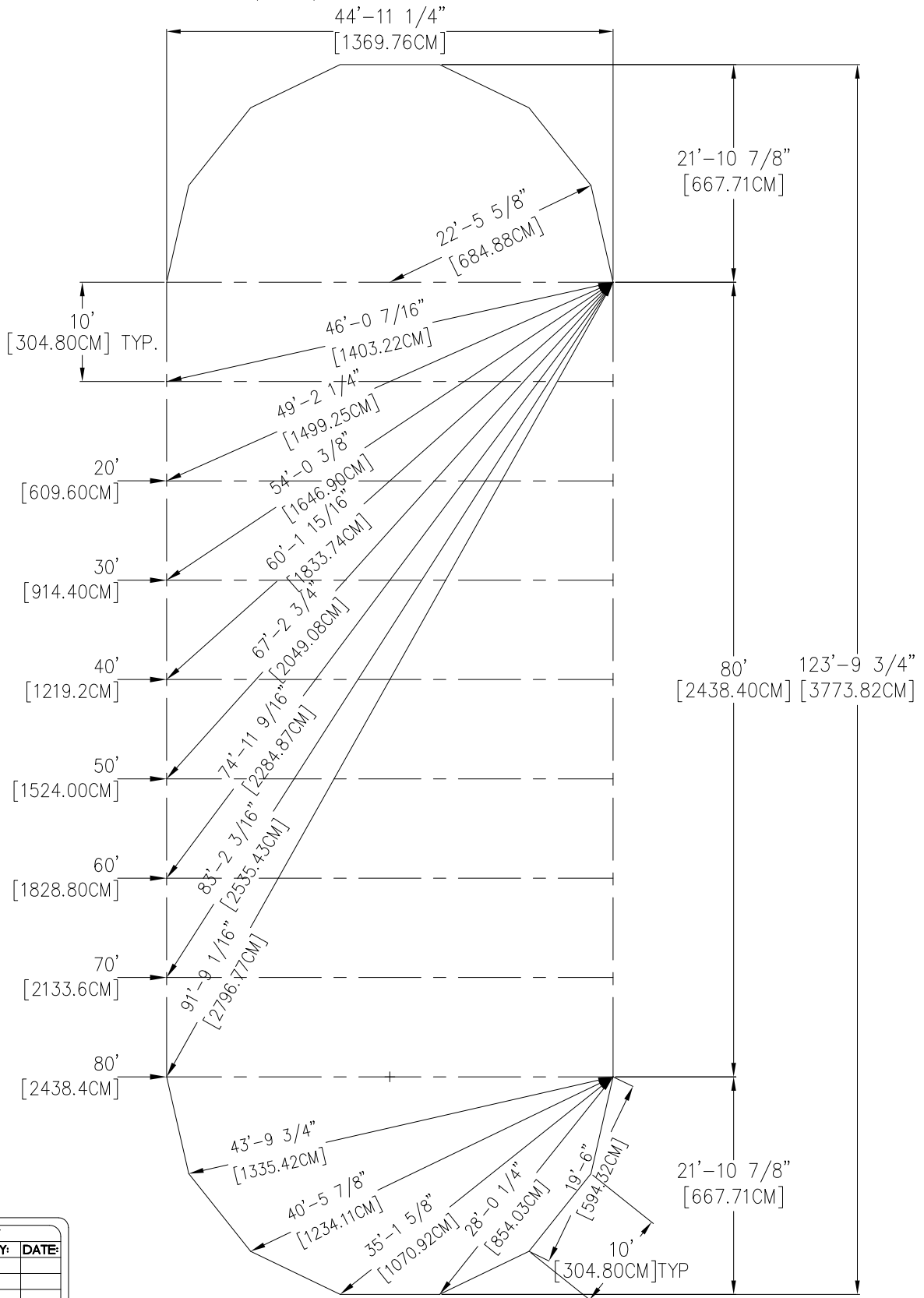

REVISION HISTORY

REV.	DESCRIPTION	BY:	DATE:

CONFIDENTIAL

ENGINEER: N/A DATE: 6/8/2017
 PAGE: 1 OF 1 DRAWN: LYZ

TIDEWATER FRAME

TIDEWATER SAILCLOTH TENT SQUARING
 44'W x 123'L (13.698M x 37.738M)

PART NUMBER: ZXXXXXX



DESIGN & PRODUCTION
 2665 COLUMBIA ST. TORRANCE, CA. 90503
 (800) 228-3687 - FAX (310) 381-0722

ALL DATA AND INFORMATION CONTAINED IN OR DISCLOSED BY THIS DOCUMENT IS CONFIDENTIAL AND PROPRIETARY INFORMATION OF AZTEC TENTS AND ALL RIGHTS THEREIN ARE EXPRESSLY RESERVED. BY ACCEPTING THIS MATERIAL THE RECIPIENT AGREES THAT THIS MATERIAL AND INFORMATION CONTAINED THEREIN IS HELD IN CONFIDENCE AND IN TRUST AND WILL NOT BE COPIED, REPRODUCED WHOLE OR IN PART, NOR ITS CONTENTS REVEALED IN ANY MANNER TO OTHERS, EXCEPT TO MEET THE SPECIFIC PURPOSE FOR WHICH IT WAS DELIVERED.

51' (16m) TIDEWATER

51'W x 51'L (16M x 15M)

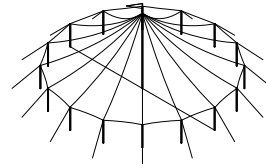
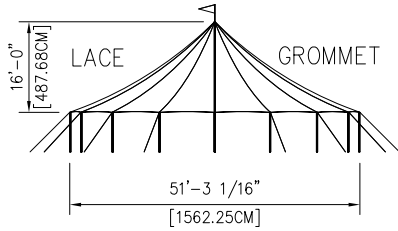

51'W x 71'L (16M x 21M)

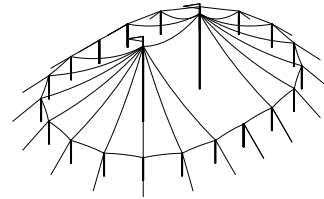
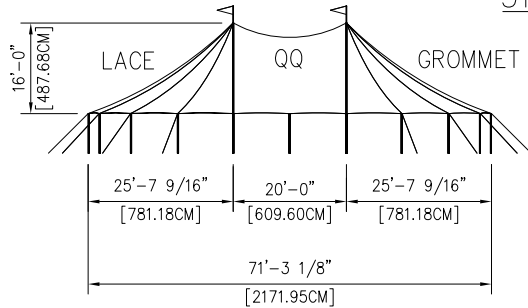

51'W x 91'L (16M x 27M)

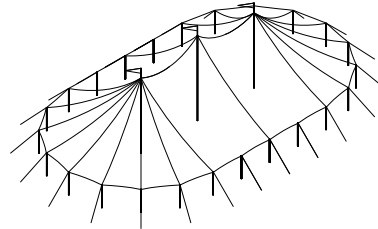
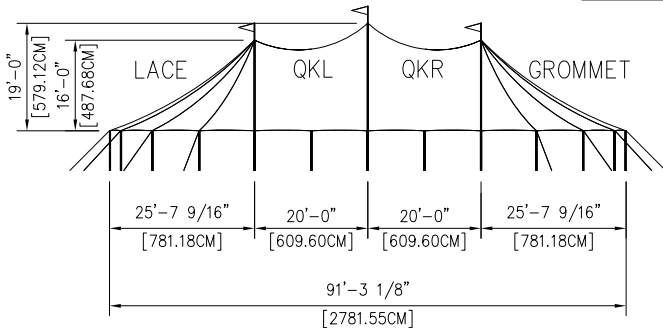

51'W x 111'L (16M x 33M)

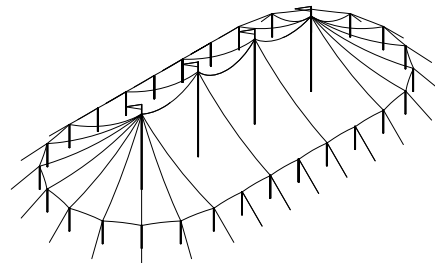
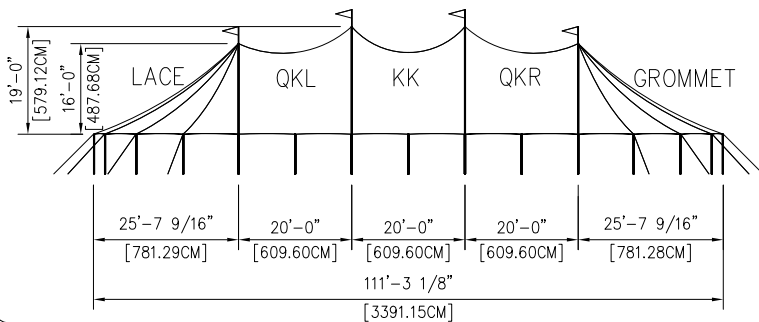

REVISION HISTORY			
REV.	DESCRIPTION	BY	DATE

CONFIDENTIAL

ENGINEER: N/A DATE: 5/3/2017
 PAGE: 1 OF 1 DRAWN: LYZ

TIDEWATER POLE TENT

51'W(15.624M) TIDEWATER

PART NUMBER: ZXXXXXX

AZTEC TENTS

DESIGN & PRODUCTION

2665 COLUMBIA ST. TORRANCE, CA. 90503
 (800) 228-3687 - FAX (310) 381-0722

ALL DATA AND INFORMATION CONTAINED IN OR DISCLOSED BY THIS DOCUMENT IS CONFIDENTIAL AND PROPRIETARY INFORMATION OF AZTEC TENTS AND ALL RIGHTS THEREIN ARE EXPRESSLY RESERVED. BY ACCEPTING THIS MATERIAL THE RECIPIENT AGREES THAT THIS MATERIAL AND INFORMATION CONTAINED THEREIN IS HELD IN CONFIDENCE AND IN TRUST AND WILL NOT BE COPIED, REPRODUCED WHOLE OR IN PART, NOR ITS CONTENTS REVEALED IN ANY MANNER TO OTHERS, EXCEPT TO MEET THE SPECIFIC PURPOSE FOR WHICH IT WAS DELIVERED.

51'W (16M) SQUARING DIAGRAM

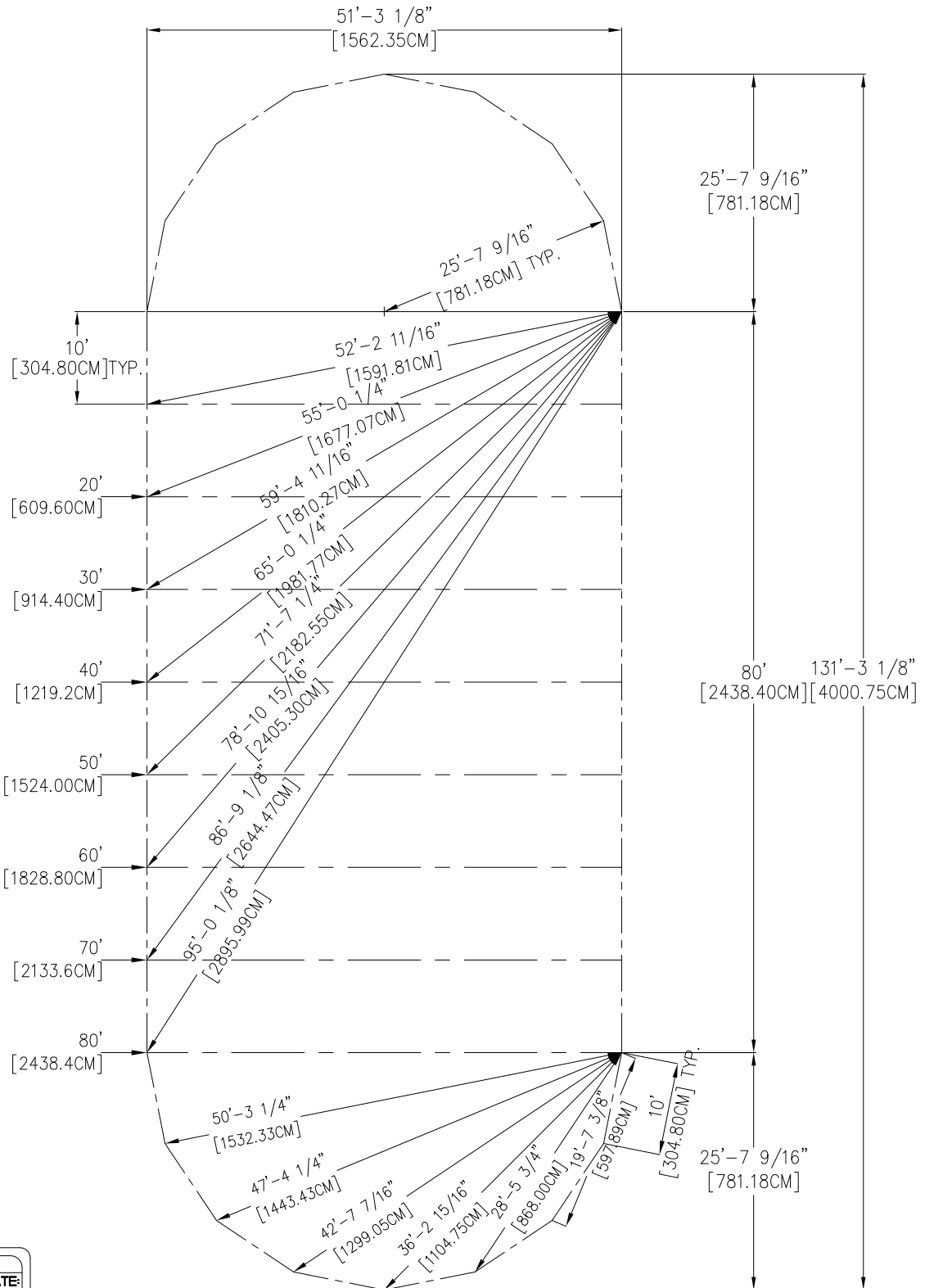

REVISION HISTORY			
REV.	DESCRIPTION	BY:	DATE:

CONFIDENTIAL

ENGINEER: N/A DATE: 4/25/2017
 PAGE: 1 OF 1 DRAWN: LYZ

TIDEWATER FRAME

TIDEWATER SAILCLOTH TENT SQUARING
 51'W x 131'L (15.624M x 40.008M)

PART NUMBER: ZXXXXXX



DESIGN & PRODUCTION
 2665 COLUMBIA ST. TORRANCE, CA. 90503
 (800) 228-3687 - FAX (310) 381-0722

ALL DATA AND INFORMATION CONTAINED IN OR DISCLOSED BY THIS DOCUMENT IS CONFIDENTIAL AND PROPRIETARY INFORMATION OF AZTEC TENTS AND ALL RIGHTS THEREIN ARE EXPRESSLY RESERVED. BY ACCEPTING THIS MATERIAL THE RECIPIENT AGREES THAT THIS MATERIAL AND INFORMATION CONTAINED THEREIN IS HELD IN CONFIDENCE AND IN TRUST AND WILL NOT BE COPIED, REPRODUCED WHOLE OR IN PART, NOR ITS CONTENTS REVEALED IN ANY MANNER TO OTHERS, EXCEPT TO MEET THE SPECIFIC PURPOSE FOR WHICH IT WAS DELIVERED.

57' (17M) TIDEWATER

57'W x 56'L (17M x 17M)

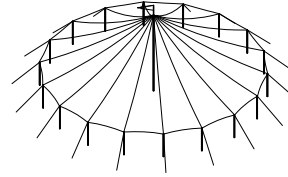
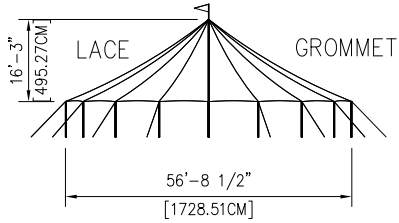

57'W x 76'L (17M x 23M)

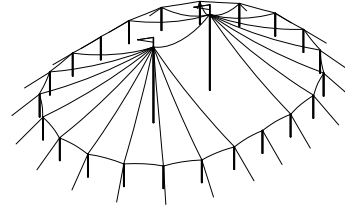
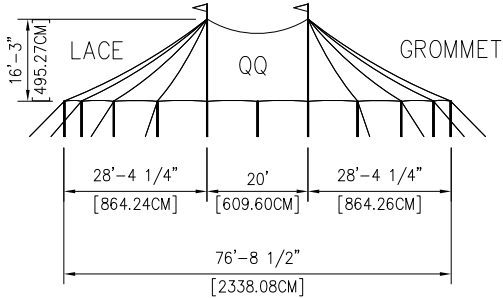

57'W x 96'L (17M x 29M)

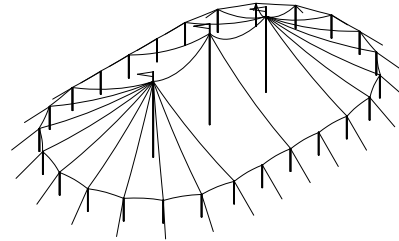
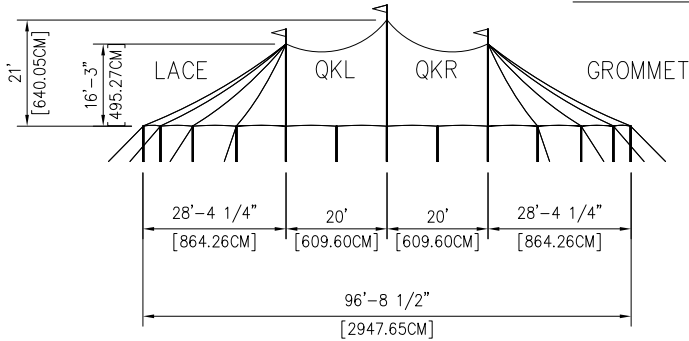

57'W x 116'L (17M x 35M)

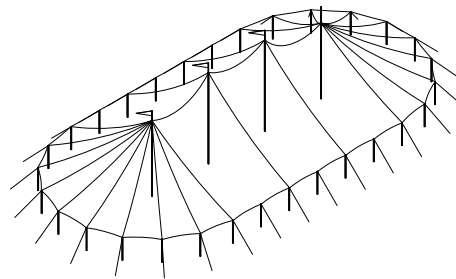
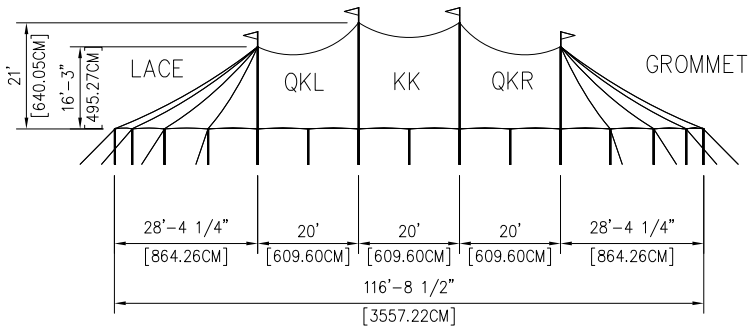

REVISION HISTORY

REV.	DESCRIPTION	BY	DATE
1	UPDATE RISE	LR	1/16/20

CONFIDENTIAL

ENGINEER: N/A DATE: 5/3/2017
 PAGE: 1 OF 1 DRAWN: LYZ

TIDEWATER POLE TENT

57'W(17.553M) TIDEWATER

PART NUMBER: ZXXXXXX



DESIGN & PRODUCTION
 2665 COLUMBIA ST. TORRANCE, CA. 90503
 (800) 228-3687 - FAX (310) 381-0722

ALL DATA AND INFORMATION CONTAINED IN OR DISCLOSED BY THIS DOCUMENT IS CONFIDENTIAL AND PROPRIETARY INFORMATION OF AZTEC TENTS AND ALL RIGHTS THEREIN ARE EXPRESSLY RESERVED. BY ACCEPTING THIS MATERIAL THE RECIPIENT AGREES THAT THIS MATERIAL AND INFORMATION CONTAINED THEREIN IS HELD IN CONFIDENCE AND IN TRUST AND WILL NOT BE COPIED, REPRODUCED WHOLE OR IN PART, NOR ITS CONTENTS REVEALED IN ANY MANNER TO OTHERS, EXCEPT TO MEET THE SPECIFIC PURPOSE FOR WHICH IT WAS DELIVERED.

57'W (17M) SQUARING DIAGRAM

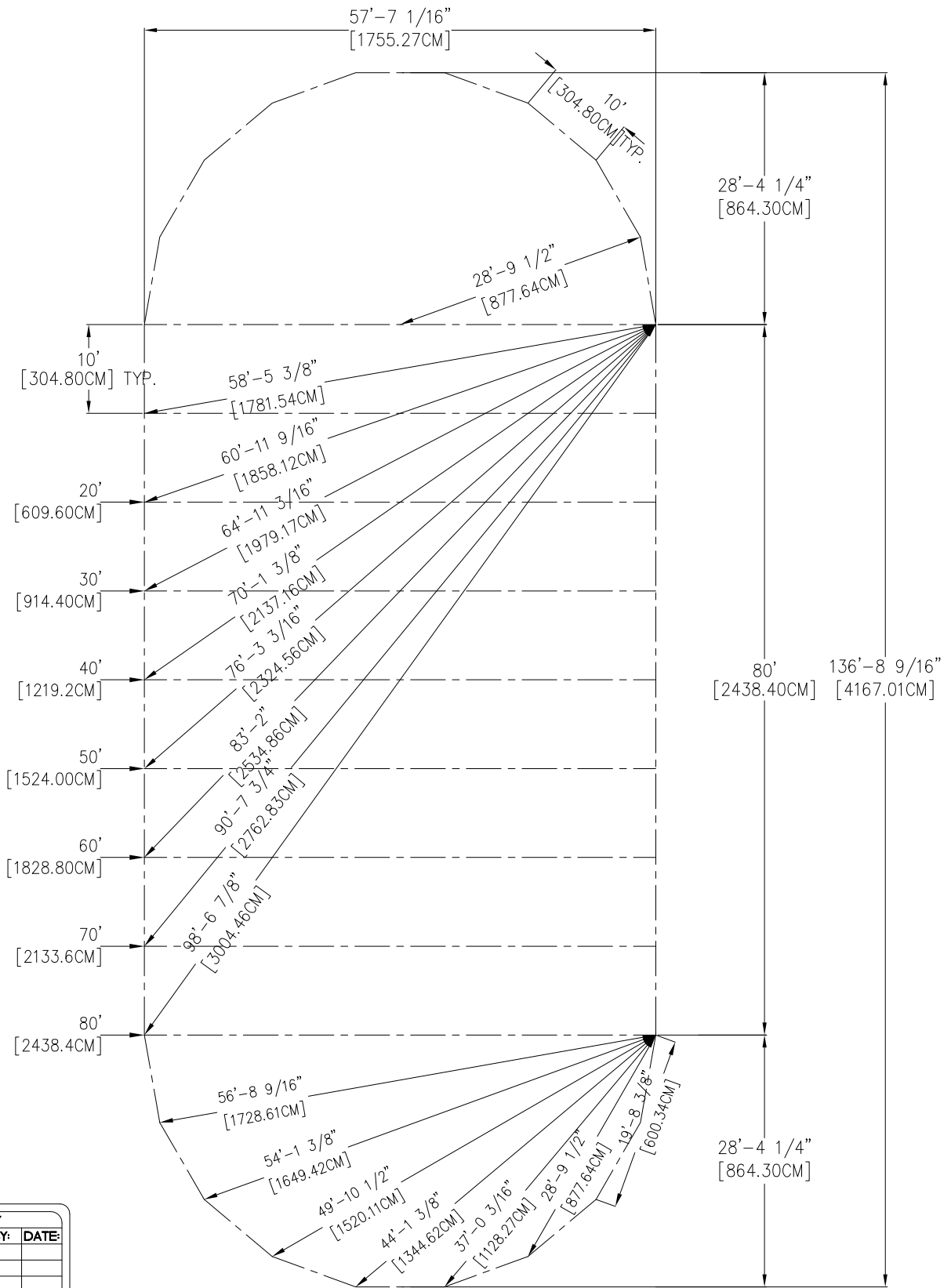

REVISION HISTORY

REV.	DESCRIPTION	BY:	DATE:

CONFIDENTIAL

ENGINEER: N/A DATE: 6/8/2017
 PAGE: 1 OF 1 DRAWN: LYZ

TIDEWATER FRAME

TIDEWATER SAILCLOTH TENT SQUARING
 57'W x 136'L (17.553M x 41.670M)
 PART NUMBER: ZXXXXXX



DESIGN & PRODUCTION
 2665 COLUMBIA ST. TORRANCE, CA. 90503
 (800) 228-3687 - FAX (310) 381-0722

ALL DATA AND INFORMATION CONTAINED IN OR DISCLOSED BY THIS DOCUMENT IS CONFIDENTIAL AND PROPRIETARY INFORMATION OF AZTEC TENTS AND ALL RIGHTS THEREIN ARE EXPRESSLY RESERVED. BY ACCEPTING THIS MATERIAL THE RECIPIENT AGREES THAT THIS MATERIAL AND INFORMATION CONTAINED THEREIN IS HELD IN CONFIDENCE AND IN TRUST AND WILL NOT BE COPIED, REPRODUCED WHOLE OR IN PART, NOR ITS CONTENTS REVEALED IN ANY MANNER TO OTHERS, EXCEPT TO MEET THE SPECIFIC PURPOSE FOR WHICH IT WAS DELIVERED.

59' (18M) TIDEWATER

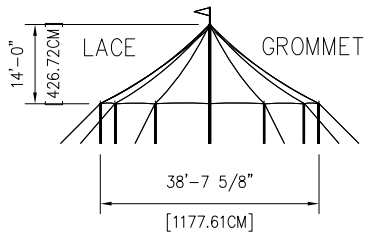

59'W x 38'L (18M x 11M)

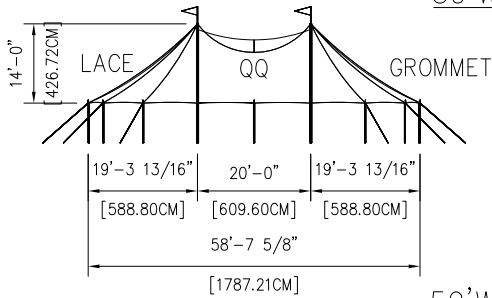
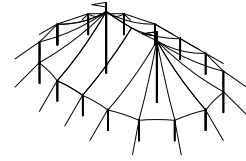

59'W x 58'L (18M x 17M)

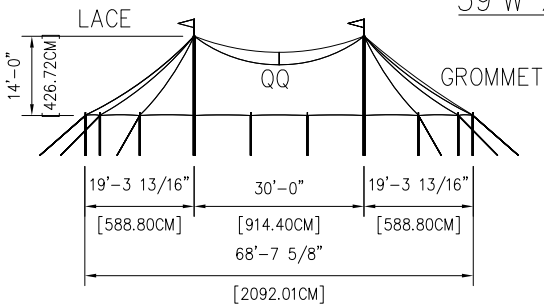
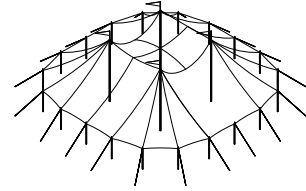

59'W x 68'L (18M x 20M)

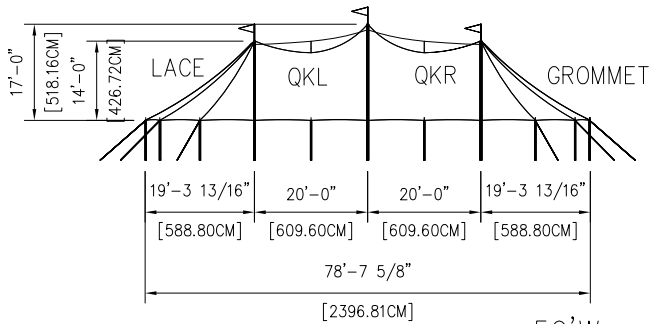
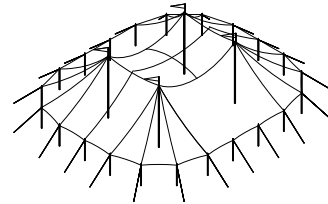

59'W x 78'L (18M x 23M)

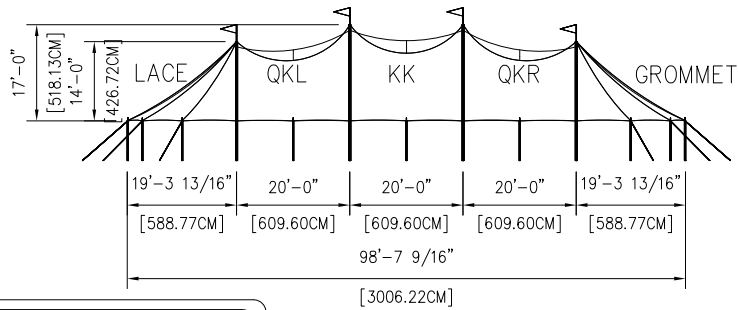
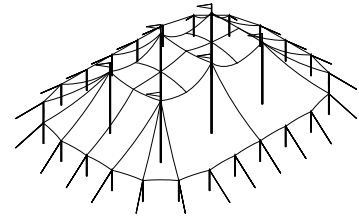

59'W x 98'L (18M x 30M)

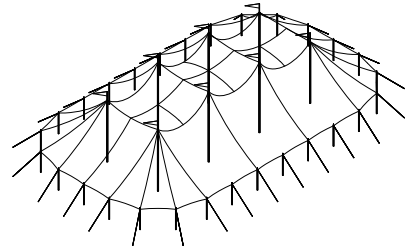

REVISION HISTORY

REV.	DESCRIPTION	BY:	DATE:

CONFIDENTIAL

ENGINEER: N/A DATE: 5/4/2017
 PAGE: 1 OF 1 DRAWN: LYZ

TIDEWATER POLE TENT

59'W(17.875M) TIDEWATER

PART NUMBER: ZXXXXXXX



DESIGN & PRODUCTION
 2665 COLUMBIA ST. TORRANCE, CA. 90503
 (800) 228-3687 - FAX (310) 381-0722

ALL DATA AND INFORMATION CONTAINED IN OR DISCLOSED BY THIS DOCUMENT IS CONFIDENTIAL AND PROPRIETARY INFORMATION OF AZTEC TENTS AND ALL RIGHTS THEREIN ARE EXPRESSLY RESERVED. BY ACCEPTING THIS MATERIAL THE RECIPIENT AGREES THAT THIS MATERIAL AND INFORMATION CONTAINED THEREIN IS HELD IN CONFIDENCE AND IN TRUST AND WILL NOT BE COPIED, REPRODUCED WHOLE OR IN PART, NOR ITS CONTENTS REVEALED IN ANY MANNER TO OTHERS, EXCEPT TO MEET THE SPECIFIC PURPOSE FOR WHICH IT WAS DELIVERED.

59'W (18M) SQUARING DIAGRAM

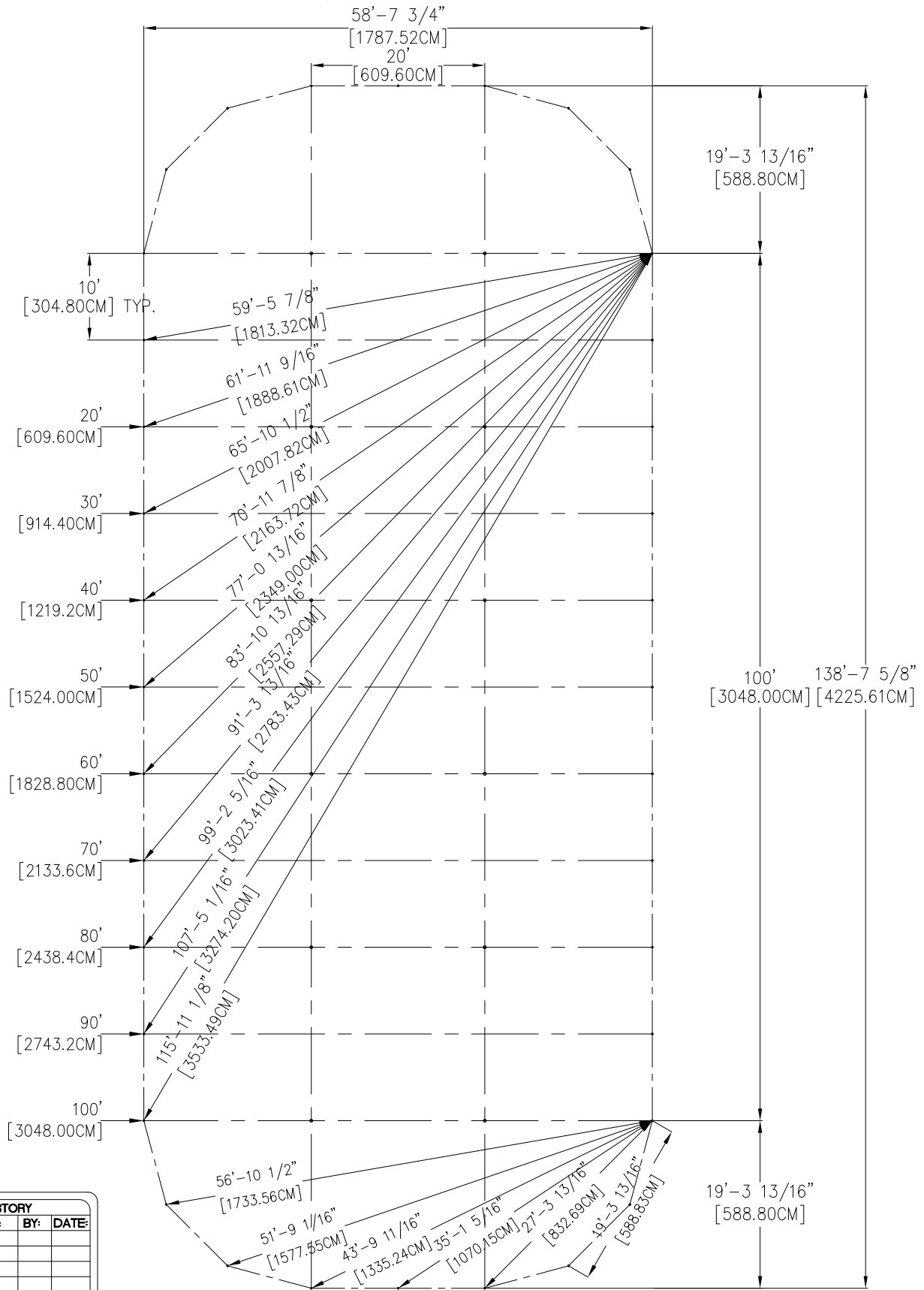

REVISION HISTORY

REV.	DESCRIPTION	BY:	DATE:

CONFIDENTIAL

ENGINEER:	N/A	DATE:	6/8/2017
PAGE:	1 OF 1	DRAWN:	LYZ

TIDEWATER FRAME

TIDEWATER SAILCLOTH TENT SQUARING

59'W x 138'L (17.875M x 42.256M)

PART NUMBER: ZXXXXXX



DESIGN & PRODUCTION

2665 COLUMBIA ST. TORRANCE, CA. 90503
(800) 228-3687 - FAX (310) 381-0722

ALL DATA AND INFORMATION CONTAINED IN OR DISCLOSED BY THIS DOCUMENT IS CONFIDENTIAL AND PROPRIETARY INFORMATION OF AZTEC TENTS AND ALL RIGHTS THEREIN ARE EXPRESSLY RESERVED. BY ACCEPTING THIS MATERIAL THE RECIPIENT AGREES THAT THIS MATERIAL AND INFORMATION CONTAINED THEREIN IS HELD IN CONFIDENCE AND IN TRUST AND WILL NOT BE COPIED, REPRODUCED WHOLE OR IN PART, NOR ITS CONTENTS REVEALED IN ANY MANNER TO OTHERS, EXCEPT TO MEET THE SPECIFIC PURPOSE FOR WHICH IT WAS DELIVERED.

81' (25M) TIDEWATER

81'W x 51'L (25M x 15M)

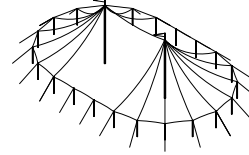
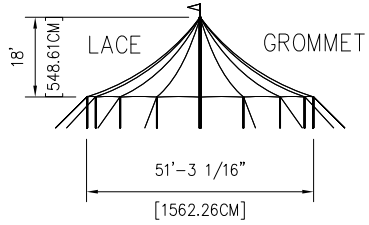

81'W x 81'L (25M x 24M)

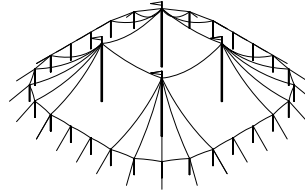
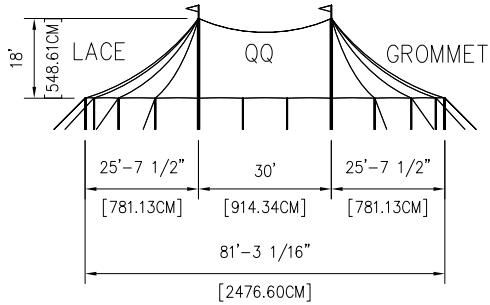

81'W x 111'L (25M x 33M)

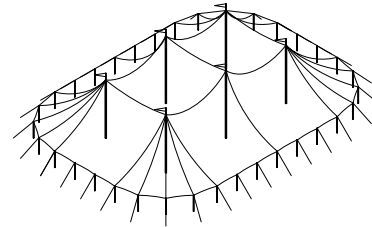
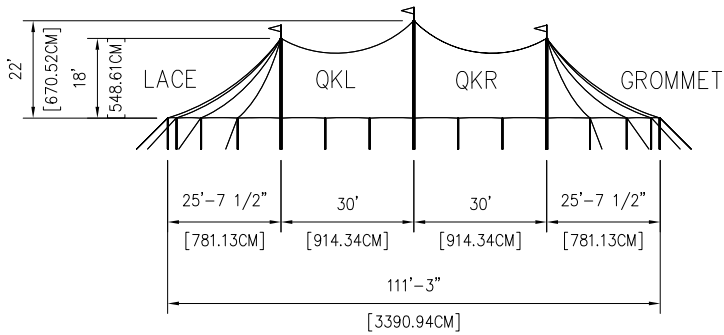

81'W x 141'L (25M x 43M)

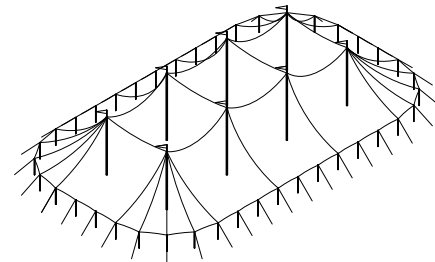
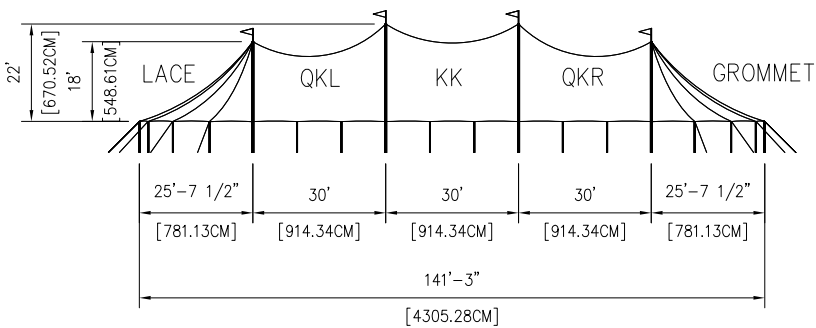

REVISION HISTORY			
REV.	DESCRIPTION	BY:	DATE:

CONFIDENTIAL

ENGINEER: N/A DATE: 5/4/2017
 PAGE: 1 OF 1 DRAWN: LYZ

TIDEWATER POLE TENT
 81'W(24.768M) TIDEWATER
 PART NUMBER: ZXXXXXXX

AZTEC TENTS
 DESIGN & PRODUCTION
 2665 COLUMBIA ST. TORRANCE, CA. 90503
 (800) 228-3687 - FAX (310) 381-0722

ALL DATA AND INFORMATION CONTAINED IN OR DISCLOSED BY THIS DOCUMENT IS CONFIDENTIAL AND PROPRIETARY INFORMATION OF AZTEC TENTS AND ALL RIGHTS THEREIN ARE EXPRESSLY RESERVED. BY ACCEPTING THIS MATERIAL THE RECIPIENT AGREES THAT THIS MATERIAL AND INFORMATION CONTAINED THEREIN IS HELD IN CONFIDENCE AND IN TRUST AND WILL NOT BE COPIED, REPRODUCED WHOLE OR IN PART, NOR ITS CONTENTS REVEALED IN ANY MANNER TO OTHERS, EXCEPT TO MEET THE SPECIFIC PURPOSE FOR WHICH IT WAS DELIVERED.

81'W (25M) SQUARING DIAGRAM

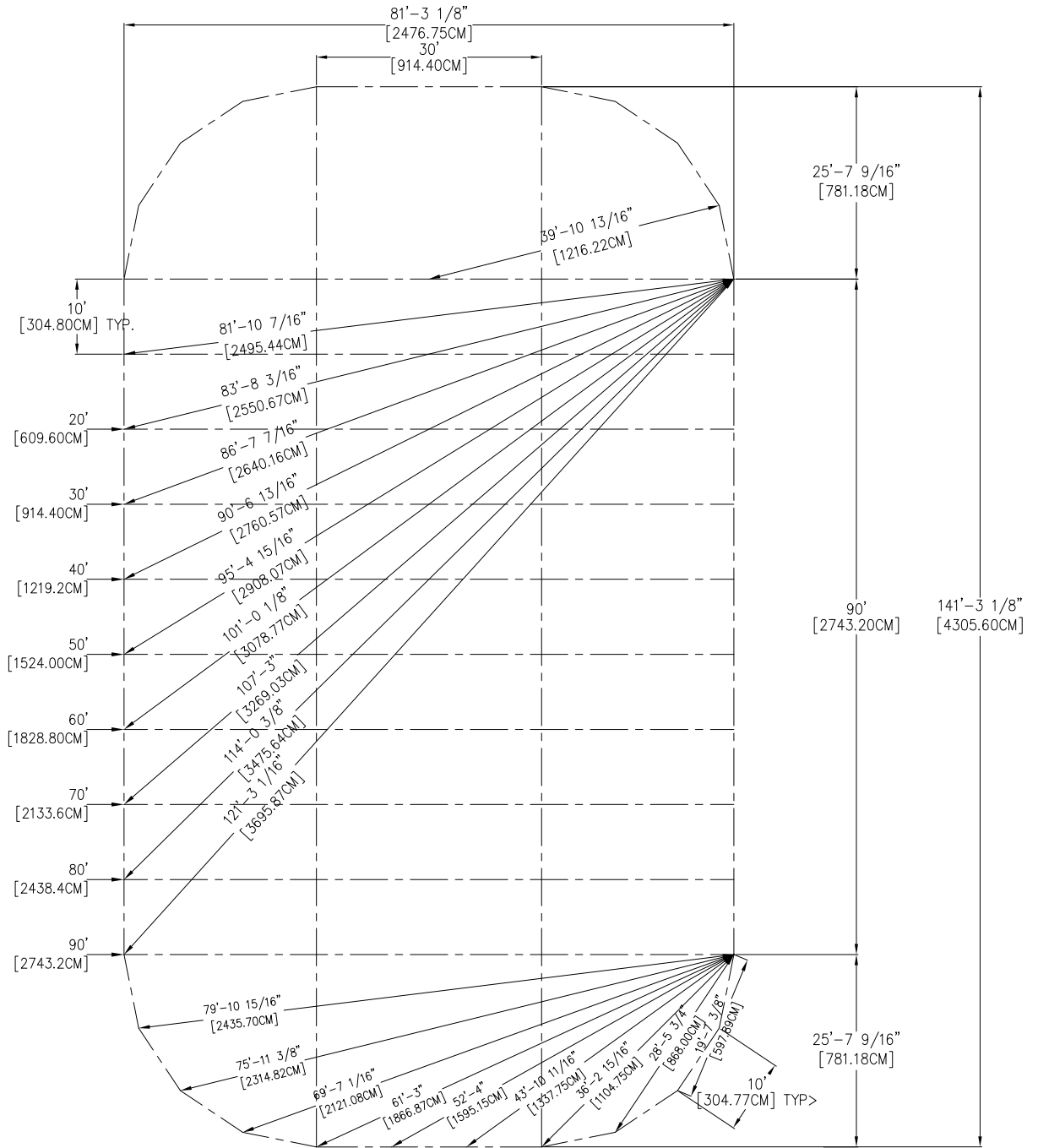

REVISION HISTORY

REV.	DESCRIPTION	BY:	DATE:

CONFIDENTIAL

ENGINEER:	N/A	DATE:	4/25/2017
PAGE:	1 OF 1	DRAWN:	LYZ

TIDEWATER FRAME

TIDEWATER SAILCLOTH TENT SQUARING
 81'W x 141'L (24.768M x 43.056M)
 PART NUMBER: ZXXXXXXX



DESIGN & PRODUCTION
 2665 COLUMBIA ST. TORRANCE, CA. 90503
 (800) 228-3687 - FAX (310) 381-0722

ALL DATA AND INFORMATION CONTAINED IN OR DISCLOSED BY THIS DOCUMENT IS CONFIDENTIAL AND PROPRIETARY INFORMATION OF AZTEC TENTS AND ALL RIGHTS THEREIN ARE EXPRESSLY RESERVED. BY ACCEPTING THIS MATERIAL THE RECIPIENT AGREES THAT THIS MATERIAL AND INFORMATION CONTAINED THEREIN IS HELD IN CONFIDENCE AND IN TRUST AND WILL NOT BE COPIED, REPRODUCED WHOLE OR IN PART, NOR ITS CONTENTS REVEALED IN ANY MANNER TO OTHERS, EXCEPT TO MEET THE SPECIFIC PURPOSE FOR WHICH IT WAS DELIVERED.

Parts Listing

Components	Item Number	Weight
Tidewater Flag White (18"x54")	Z335ZFLAG	2
Tidewater Flag White (18"x120")	Z335ZFLAG10	2
Tidewater Flagpole	Z335ZFLAGPOLELG	3
7x10 Tidewater Solid Wall-Wht	Z338071001	6
7x10 Tidewater Panorama(P1)	Z338071002	7
7x10 Tidewater French(F1) Wall	Z338071003	7
7x10 Tidewater Clear Wall-Wht	Z338071004	9
8x10 Tidewater Solid Wall-Wht	Z338081001	7
8x10 Tidewater Panorama(P1)	Z338081002	8
8x10 Tidewater French(F1) Wall	Z338081003	8
8x10 Tidewater Clear Wall-Wht	Z338081004	10
2.5" 2pc Tidewater CP x 15'0"	Z3962.500TX1500	13
2.5" 2pc Tidewater CP x 16'0"	Z3962.500TX1600	14
4.0" 2pc Tidewater CP x 18'0"	Z3964.000TX1800	41
4.0" 2pc Tidewater CP x 19'0"	Z3964.000TX1900	43
4.0" 3pc Tidewater CP x 20'0"	Z3964.000TX2000	45
4.0" 3pc Tidewater CP x 21'0"	Z3964.000TX2100B	47
4.0" 3pc Tidewater CP x 22'0"	Z3964.000TX2200	49
4.0" 4pc Tidewater CP x 24'0"	Z3964.000TX2400	59
4.0" 4pc Tidewater CP x 25'0"	Z3964.000TX2500	61
4" SCH40 2pc Tidewater CPx23'0"	Z3964SCH40X2300	120
4" SCH40 2pc Tidewater CPx24'0"	Z3964SCH40X2400	124
4" SCH40 2pc Tidewater CPx26'0"	Z3964SCH40X2600	131
4" SCH40 2pc Tidewater CPx27'0"	Z3964SCH40X2700B	134
2.5" 1pc Alum SP x 7'0"	Z3912.5BX07	7
2.5" 1pc Alum SP x 8'0"	Z3912.5BX08	8
3x3 Wood Sidepole x 7'	Z391WOOD3X37	26
3x3 Wood Sidepole x 8'	Z391WOOD3X38	28
Tidewater Gutter System Kit	Z39900391	
Tidewater Gutter - Fabric Only	Z39900392	5
Tidewater Gutter Bracket Set	Z39900393	4
Tidewater Squaring Jig - 20'x	Z3990039420	2
Tidewater Squaring Jig - 32'x	Z3990039432	2
Tidewater Squaring Jig - 44'x	Z3990039444	2
Tidewater Squaring Jig - 51'x	Z3990039451	2
Tidewater Squaring Jig - 59'x	Z399003459	4
Tidewater Squaring Jig - 81'x	Z399003481	4
Tidewater Install Strap	Z39900397	2
Tidewater Cord Cover - 20x	Z3990039520	2
Tidewater Cord Cover - 32x END	Z3990039532E	4
Tidewater Cord Cover - 32x MID	Z3990039532M	4
Tidewater Cord Cover - 44x END	Z3990039544E	4
Tidewater Cord Cover - 44x MID	Z3990039544M	4
Tidewater Cord Cover - 51x END	Z3990039551E	4
Tidewater Cord Cover - 51x MID	Z3990039551M	4
Tidewater Cord Cover - 59x END	Z3990039559E	4
Tidewater Cord Cover - 59x MID	Z3990039559M	4
Tidewater Cord Cover - 81x END	Z39900395581E	4
Tidewater Cord Cover - 81x MID	Z39900395581M	4
24" Steel Stake w/Welded Hook	Z51100020	3
1" x 42" Double Headed Stake	Z51100070	10
1" Inline Ratchet	Z39900280	3
2" Inline Ratchet	Z39900290	6
Web Ratchet Assembly w/16' Web	Z39900310	8

Tidewater® Parts Images



Tidewater Flag-54"



Tidewater Flag-120"



Tidewater Flagpole



Tidewater Install Strap



Tidewater Cord Cover



2.5" 1pc Alum SP



3x3 Wood Sidepole



Wood Grain Powder coated SP



Wood Grain Powder coated CP



Aluminum Center Pole



2" In-Line Ratchet



1" In-Line Ratchet



1"x42" Stake



Web Winch Assembly



Stake Bar



Side Pole Light Bracket



Tidewater Wave Entrance



Tidewater Gutter



Tidewater Wave Connector



Tidewater Jig

Tidewater® Engineering Specifications

Design Criteria:

Code: ASCE 7-10

Wind Speed: Varies according to specifications below

Exposure: Category C (Open Terrain)

Mean Recurrence Interval (MRI): 2Years

Building Category: II

Notes:

The following loading for suspended equipment has been included within the calculations. Maximum hanging load per leg is 50lbs, and maximum hanging load per centerpole is 200lbs.

All analysis and reactions below have been completed assuming the tent is completely walled.

External Guys to be installed at distance of 12" less than the height of the side pole

Tent is not engineered for snow or live loading.

Recommended Factor of Safety for edge post tieback guys: 3.0 times the maximum design tension. Loadings shown are per location. Loadings can be resisted with multiple tieback guys to attain acceptable working load value per strap/guy.

A Factor of Safety of 2.0 times the design load has been used for the pull out tension in lbs that the anchoring devices must resist in the direction of the load. Ensure that the anchors installed are adequate to resist pull out loads show on the diagram. Actual testing of some individual anchors to 75% of the anchor pull-out load is recommended.

Each component of the Tent should be inspected at the beginning and the end of each installation for visual signs of damage by the installer. All damaged materials should be repaired or replaced immediately.

Tidewater® Load Summary- 20' (6m) Width

LD Pole Design-

115mph wind speed reduced to 78mph effective wind speed

Sidepole- 2.5" OD x 0.083" wall 6061-T6 Aluminum

Center pole- 4.0" OD x 0.125" wall 6061-T6 Aluminum

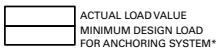
SAMPLE

* MINIMUM DESIGN LOAD FOR ANCHORING SYSTEM IS CALCULATED USING A FACTOR OF SAFETY = 2.0. SOME FIXED MECHANICAL ANCHORS HAVING ULTIMATE LOADS IN EXCESS OF THIS SPECIFIED LOAD CAN BE USED, BUT THOSE ANCHORS MUST ALSO HAVE ALLOWABLE/WORKING LOADS GREATER THAN ACTUAL LOAD VALUE.

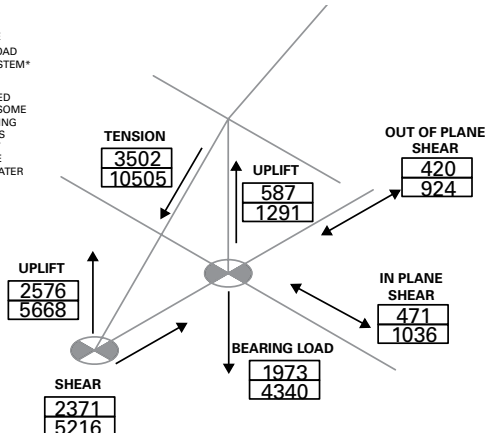

HD Pole Design-

140mph wind speed reduced to 95mph effective wind speed

Sidepole- 2.0" SCH40 6061-T6 Aluminum

Center pole- 4.0" SCH40 6061-T6 Aluminum

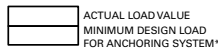
SAMPLE

* MINIMUM DESIGN LOAD FOR ANCHORING SYSTEM IS CALCULATED USING A FACTOR OF SAFETY = 2.0. SOME FIXED MECHANICAL ANCHORS HAVING ULTIMATE LOADS IN EXCESS OF THIS SPECIFIED LOAD CAN BE USED, BUT THOSE ANCHORS MUST ALSO HAVE ALLOWABLE/WORKING LOADS GREATER THAN ACTUAL LOAD VALUE.

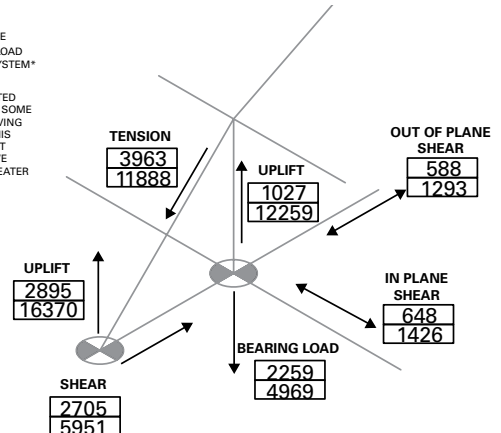

Tidewater® Load Summary- 32' (10m) Width

LD Pole Design-

115mph wind speed reduced to 78mph effective wind speed
 Sidepole- 2.5"OD x 0.083" wall 6061-T6 Aluminum
 Center pole- 4.0" OD x 0.125" wall 6061-T6 Aluminum

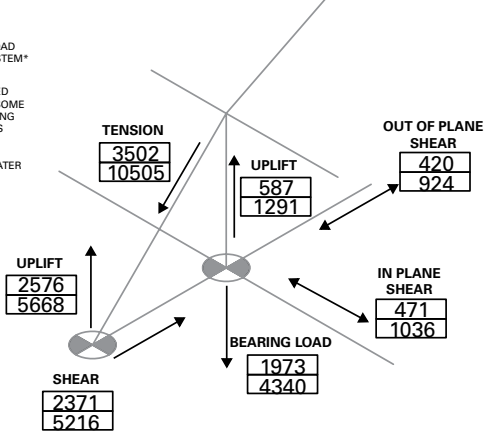
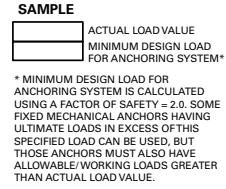

HD Pole Design-

140mph wind speed reduced to 95mph effective wind speed
 Sidepole- 2.0" SCH40 6061-T6 Aluminum
 Center pole- 4.0" SCH40 6061-T6 Aluminum

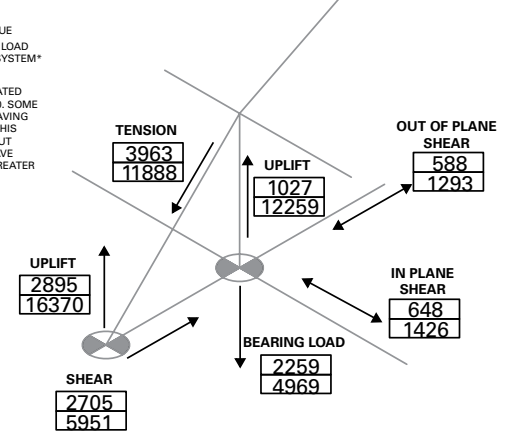
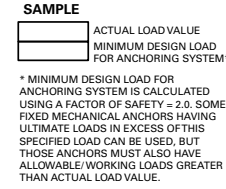

Tidewater® Load Summary- 44' (14m) Width

LD Pole Design-

65mph wind speed reduced to 44mph effective wind speed
 Sidepole- 2.5"OD x 0.083" wall 6061-T6 Aluminum
 Center pole- 4.0" OD x 0.125" wall 6061-T6 Aluminum

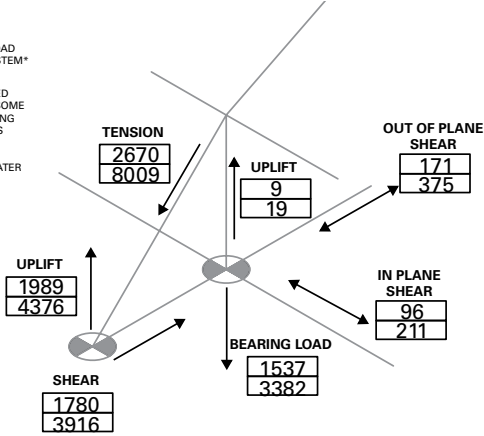
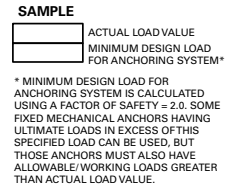

HD Pole Design-

115mph wind speed reduced to 78mph effective wind speed
 Sidepole- 2.0" SCH40 6061-T6 Aluminum
 Center pole- 4.0" SCH40 6061-T6 Aluminum

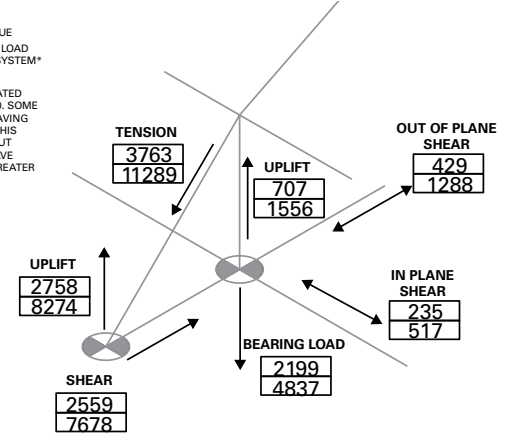
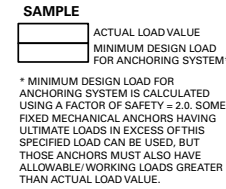

Tidewater® Load Summary- 51' (16m) Width

LD Pole Design-

115mph wind speed reduced to 78mph effective wind speed
 Sidepole- 2.5"OD x 0.083" wall 6061-T6 Aluminum
 Center pole- 4.0" SCH40 6061-T6 Aluminum

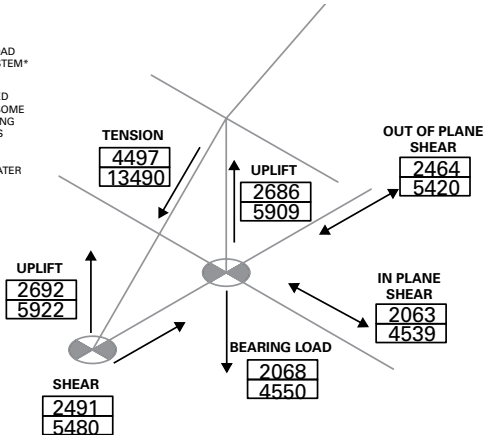
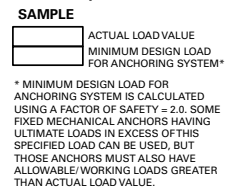

HD Pole Design-

140mph wind speed reduced to 95mph effective wind speed
 Sidepole- 2.0" SCH40 6061-T6 Aluminum
 Center pole- 4.0" SCH40 6061-T6 Aluminum

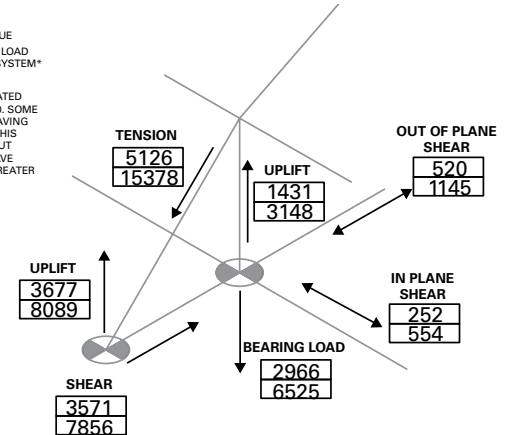
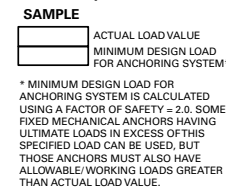

Tidewater® Load Summary- 57' (17m) Width

LD Pole Design-

115mph wind speed reduced to 78mph effective wind speed

Sidepole- 2.5"OD x 0.083" wall 6061-T6 Aluminum

Center pole- 4.0" SCH40 6061-T6 Aluminum

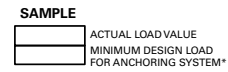

* MINIMUM DESIGN LOAD FOR ANCHORING SYSTEM IS CALCULATED USING A FACTOR OF SAFETY = 2.0. SOME FIXED MECHANICAL ANCHORS HAVING ULTIMATE LOADS IN EXCESS OF THIS SPECIFIED LOAD CAN BE USED, BUT THOSE ANCHORS MUST ALSO HAVE ALLOWABLE/WORKING LOADS GREATER THAN ACTUAL LOAD VALUE.

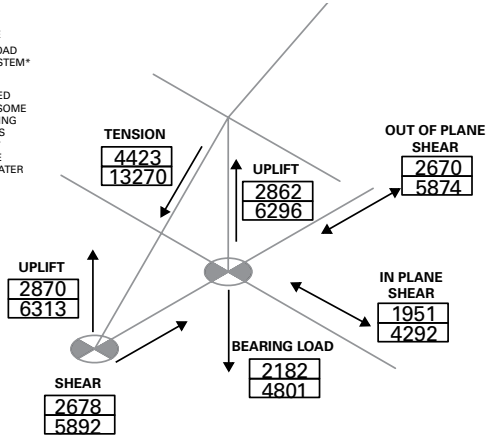

HD Pole Design-

140mph wind speed reduced to 95mph effective wind speed

Sidepole- 2.0" SCH40 6061-T6 Aluminum

Center pole- 4.0" SCH40 6061-T6 Aluminum

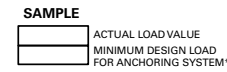

* MINIMUM DESIGN LOAD FOR ANCHORING SYSTEM IS CALCULATED USING A FACTOR OF SAFETY = 2.0. SOME FIXED MECHANICAL ANCHORS HAVING ULTIMATE LOADS IN EXCESS OF THIS SPECIFIED LOAD CAN BE USED, BUT THOSE ANCHORS MUST ALSO HAVE ALLOWABLE/WORKING LOADS GREATER THAN ACTUAL LOAD VALUE.

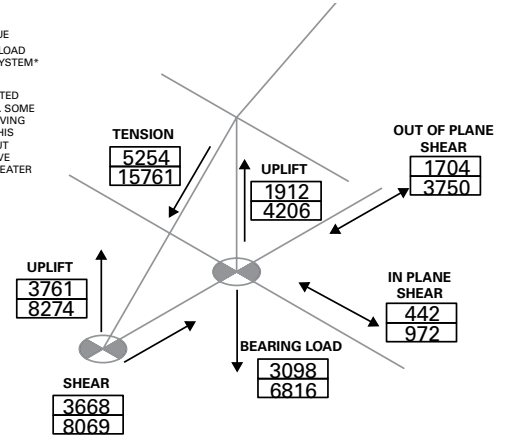

Tidewater® Load Summary- 59' (18m) Width

LD Pole Design-

95mph wind speed reduced to 65mph effective wind speed

Sidepole- 2.5"OD x 0.083" wall 6061-T6 Aluminum

Center pole- 4.0" OD x 0.125" wall 6061-T6 Aluminum

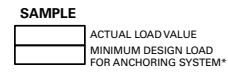

* MINIMUM DESIGN LOAD FOR ANCHORING SYSTEM IS CALCULATED USING A FACTOR OF SAFETY = 2.0. SOME FIXED MECHANICAL ANCHORS HAVING ULTIMATE LOADS IN EXCESS OF THIS SPECIFIED LOAD CAN BE USED, BUT THOSE ANCHORS MUST ALSO HAVE ALLOWABLE/WORKING LOADS GREATER THAN ACTUAL LOAD VALUE.

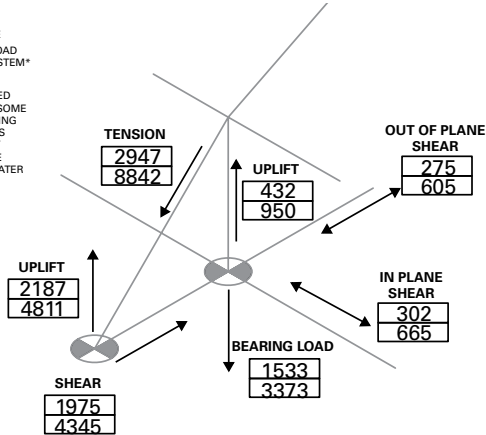

HD Pole Design-

115mph wind speed reduced to 78mph effective wind speed

Sidepole- 2.0" SCH40 6061-T6 Aluminum

Center pole- 4.0" SCH40 6061-T6 Aluminum

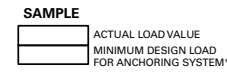

* MINIMUM DESIGN LOAD FOR ANCHORING SYSTEM IS CALCULATED USING A FACTOR OF SAFETY = 2.0. SOME FIXED MECHANICAL ANCHORS HAVING ULTIMATE LOADS IN EXCESS OF THIS SPECIFIED LOAD CAN BE USED, BUT THOSE ANCHORS MUST ALSO HAVE ALLOWABLE/WORKING LOADS GREATER THAN ACTUAL LOAD VALUE.

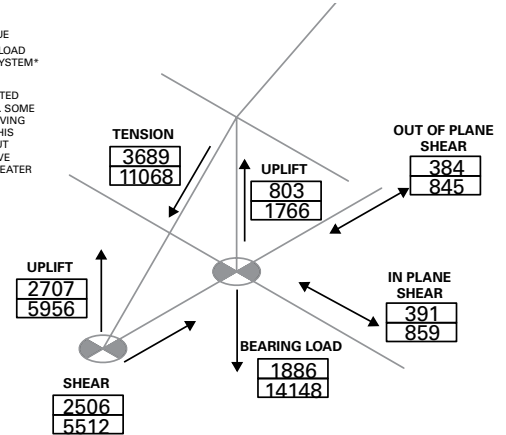

Tidewater® Load Summary- 81' (25m) Width

HD Pole Design-

140mph wind speed reduced to 95mph effective wind speed

Sidepole- 2.5" SCH40 6061-T6 Aluminum

Center pole- 6.0" SCH40 6061-T6 Aluminum

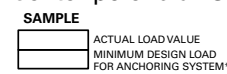

* MINIMUM DESIGN LOAD FOR ANCHORING SYSTEM IS CALCULATED USING A FACTOR OF SAFETY = 2.0. SOME FIXED MECHANICAL ANCHORS HAVING ULTIMATE LOADS IN EXCESS OF THIS SPECIFIED LOAD CAN BE USED, BUT THOSE ANCHORS MUST ALSO HAVE ALLOWABLE/WORKING LOADS GREATER THAN ACTUAL LOAD VALUE.

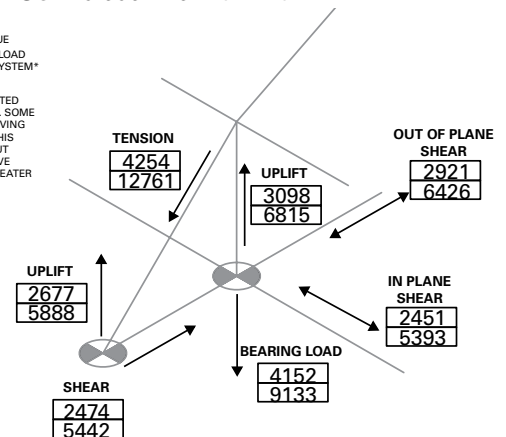

If YOU can IMAGINE it... WE can BUILD it

www.aztectents.com

Aztec Tents

2665 Columbia Street
Torrance, CA 90503
Toll Free (800) 228-3687
Fax (310) 381-0722