

ISOMETRIC VIEW

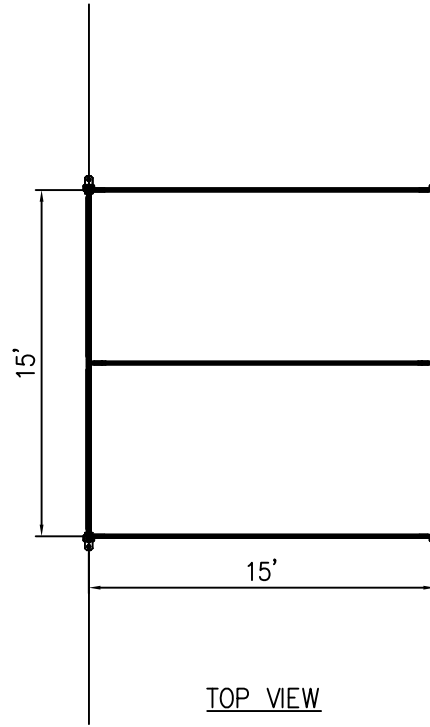

TOP VIEW

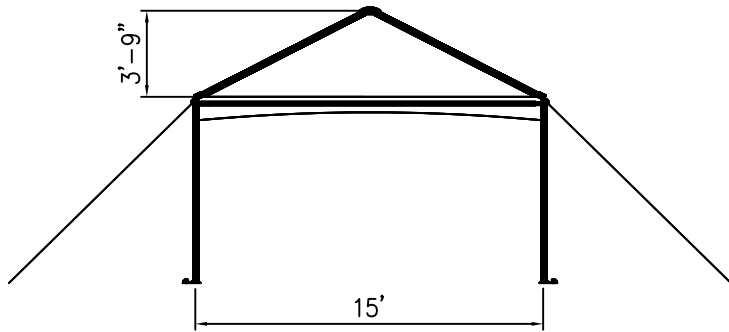

SIDE VIEW

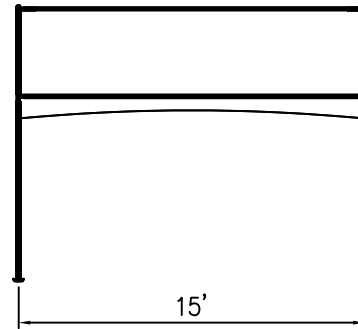

FRONT VIEW

ALL DATA AND INFORMATION CONTAINED IN OR DISCLOSED BY THIS DOCUMENT IS CONFIDENTIAL AND PROPRIETARY INFORMATION OF AZTEC TENTS AND ALL RIGHTS THEREIN ARE EXPRESSLY RESERVED. BY ACCEPTING THIS MATERIAL THE RECIPIENT AGREES THAT THIS MATERIAL AND INFORMATION CONTAINED THEREIN IS HELD IN CONFIDENCE AND IN TRUST AND WILL NOT BE COPIED, REPRODUCED WHOLE OR IN PART, NOR ITS CONTENTS REVEALED IN ANY MANNER TO OTHERS, EXCEPT TO MEET THE SPECIFIC PURPOSE FOR WHICH IT WAS DELIVERED.

**AZTEC TENTS**  
 DESIGN & PRODUCTION  
 2665 COLUMBIA ST. TORRANCE, CA. 90503  
 (800) 228-3687 - FAX (310) 381-0722

**JUMBOTRAC LITE**  
 15'W X 15'L  
 PART NUMBER: ZXXXXXXX

REVISION HISTORY			
REV.	DESCRIPTION	BY:	DATE:

**CONFIDENTIAL**

ENGINEER: N/A	DATE: 5/5/2016
PAGE: 1 OF 1	DRAWN: HUGO.R

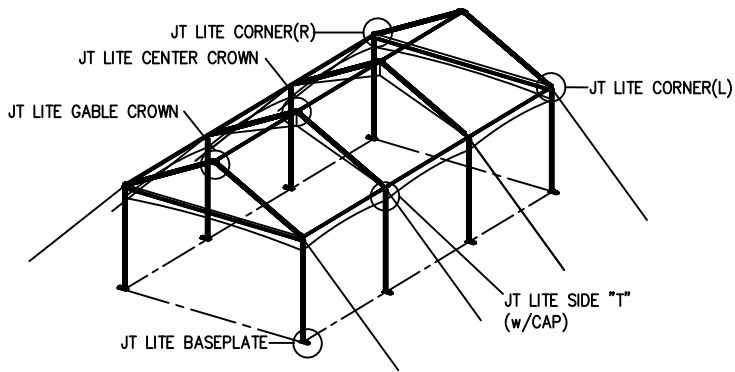

ISOMETRIC VIEW

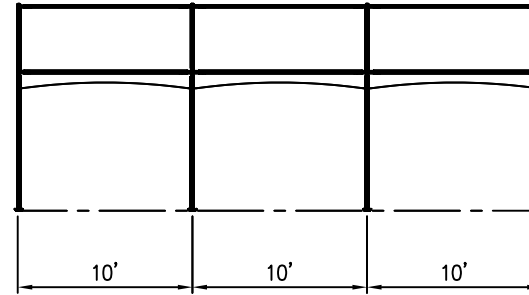

SIDE VIEW

15'W x 30'L JUMBOTRAC LITE GABLE w/ JT LITE LEGS

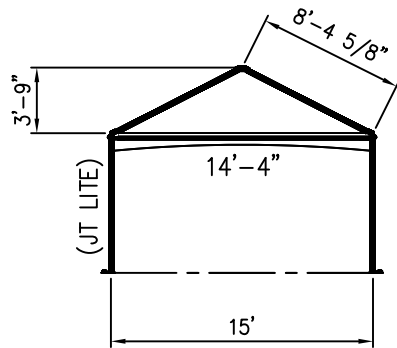

FRONT VIEW

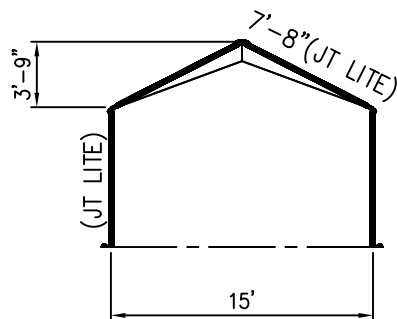

CENTER BAY

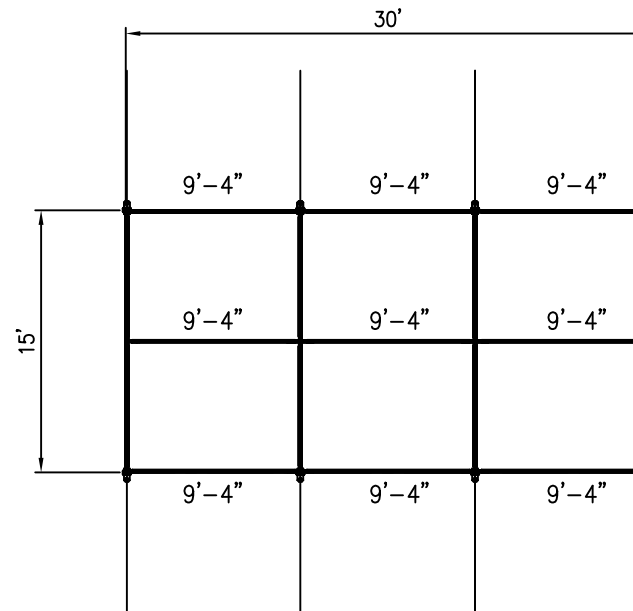

PLAN VIEW

ALL DATA AND INFORMATION CONTAINED IN OR DISCLOSED BY THIS DOCUMENT IS CONFIDENTIAL AND PROPRIETARY INFORMATION OF AZTEC TENTS AND ALL RIGHTS THEREIN ARE EXPRESSLY RESERVED. BY ACCEPTING THIS MATERIAL THE RECIPIENT AGREES THAT THIS MATERIAL AND INFORMATION CONTAINED THEREIN IS HELD IN CONFIDENCE AND IN TRUST AND WILL NOT BE COPIED, REPRODUCED WHOLE OR IN PART, NOR ITS CONTENTS REVEALED IN ANY MANNER TO OTHERS, EXCEPT TO MEET THE SPECIFIC PURPOSE FOR WHICH IT WAS DELIVERED.

**AZTEC TENTS**  
 DESIGN & PRODUCTION  
 2665 COLUMBIA ST. TORRANCE, CA. 90503  
 (800) 228-3687 - FAX (310) 381-0722

JT LITE FRAME TENT  
 15'W x 30'L w/ 10'MIDS  
 PART NUMBER:

REVISION HISTORY			
REV.	DESCRIPTION	BY:	DATE:

**SALES**

ENGINEER:	N/A	DATE:	1/11/2018
PAGE:	1 OF 1	DRAWN:	LYZ R.

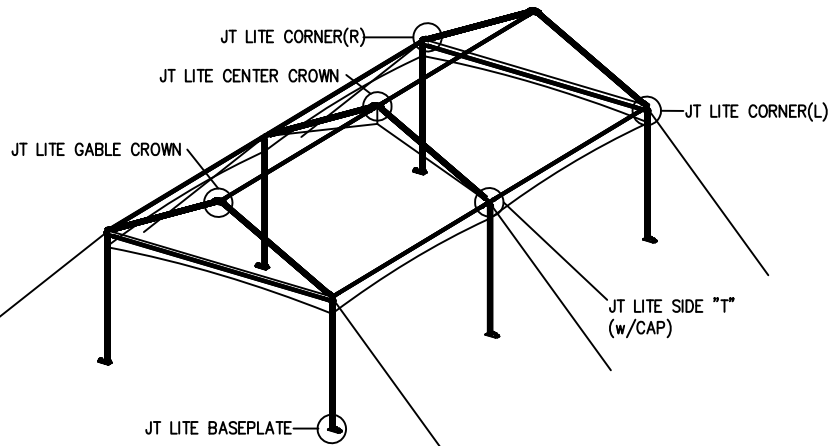

ISOMETRIC VIEW

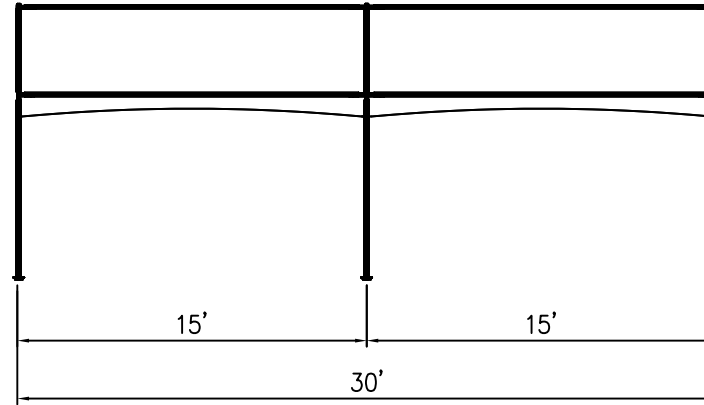

SIDE VIEW

15'W x 30'L JUMBOTRAC LITE GABLE w/ JT LITE LEGS

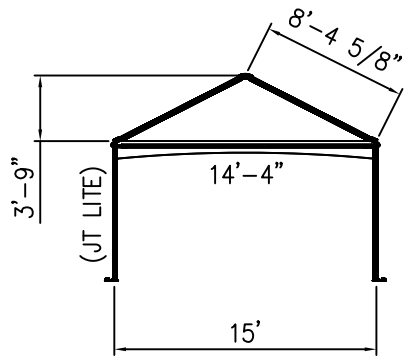

FRONT VIEW

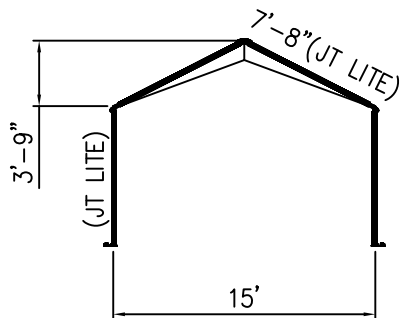

CENTER BAY

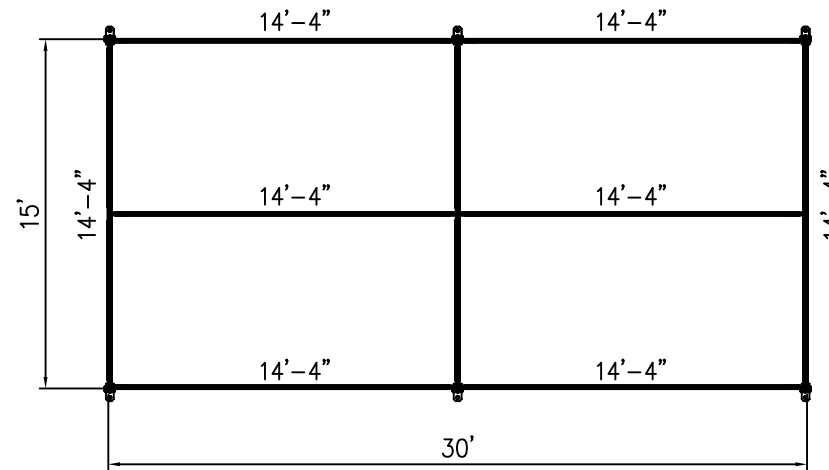

PLAN VIEW

ALL DATA AND INFORMATION CONTAINED IN OR DISCLOSED BY THIS DOCUMENT IS CONFIDENTIAL AND PROPRIETARY INFORMATION OF AZTEC TENTS AND ALL RIGHTS THEREIN ARE EXPRESSLY RESERVED. BY ACCEPTING THIS MATERIAL THE RECIPIENT AGREES THAT THIS MATERIAL AND INFORMATION CONTAINED THEREIN IS HELD IN CONFIDENCE AND IN TRUST AND WILL NOT BE COPIED, REPRODUCED WHOLE OR IN PART, NOR ITS CONTENTS REVEALED IN ANY MANNER TO OTHERS, EXCEPT TO MEET THE SPECIFIC PURPOSE FOR WHICH IT WAS DELIVERED.

**AZTEC TENTS**  
 DESIGN & PRODUCTION  
 2665 COLUMBIA ST. TORRANCE, CA. 90503  
 (800) 228-3687 - FAX (310) 361-0722

**PRODUCT**  
 JUMBOTRAC LITE/GABLE  
 15'W X 30'L  
 PART NUMBER: ZXXXXXXX

REVISION HISTORY			
REV.	DESCRIPTION	BY:	DATE:

**CONFIDENTIAL**

ENGINEER:	N/A	DATE:	1/11/2018
PAGE:	1 OF 1	DRAWN:	LYZ R.

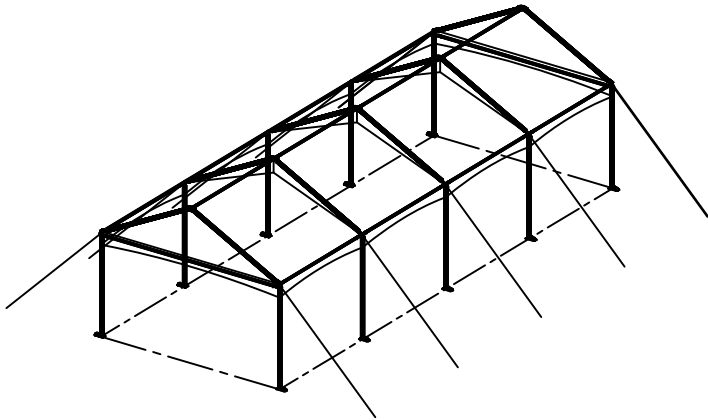

ISOMETRIC VIEW

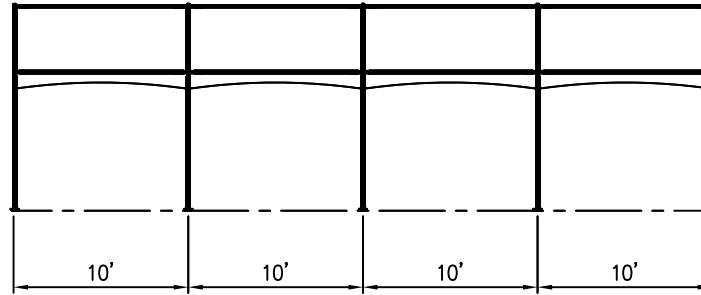

SIDE VIEW

15'W x 40'L JUMBOTRAC LITE GABLE w/ JT LITE LEGS

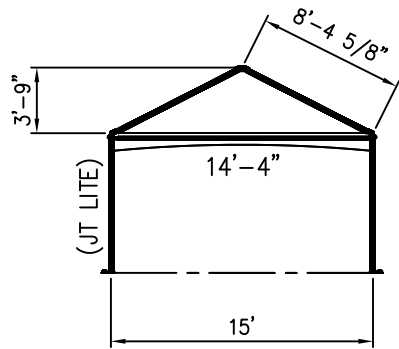

FRONT VIEW

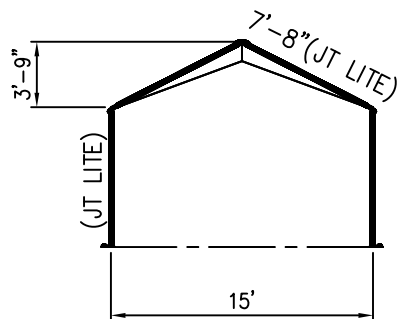

CENTER BAY

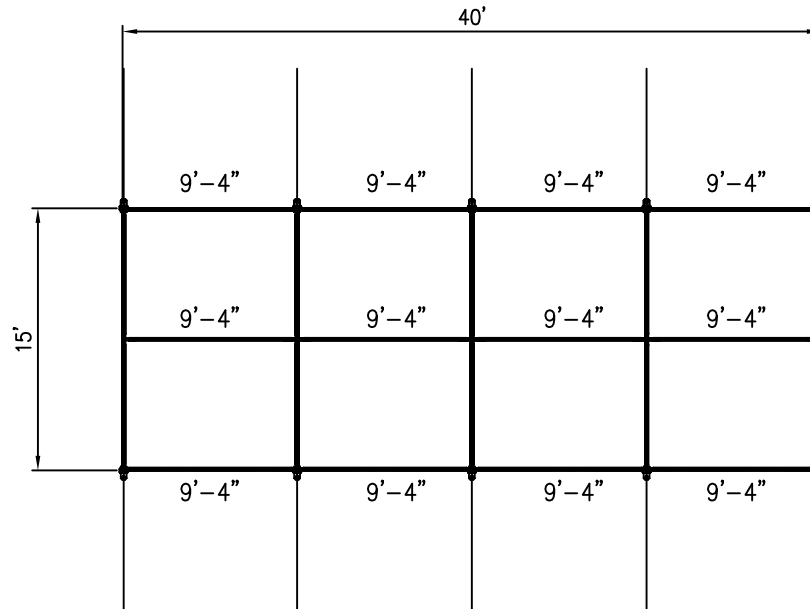

PLAN VIEW

ALL DATA AND INFORMATION CONTAINED IN OR DISCLOSED BY THIS DOCUMENT IS CONFIDENTIAL AND PROPRIETARY INFORMATION OF AZTEC TENTS AND ALL RIGHTS THEREIN ARE EXPRESSLY RESERVED. BY ACCEPTING THIS MATERIAL THE RECIPIENT AGREES THAT THIS MATERIAL AND INFORMATION CONTAINED THEREIN IS HELD IN CONFIDENCE AND IN TRUST AND WILL NOT BE COPIED, REPRODUCED WHOLE OR IN PART, NOR ITS CONTENTS REVEALED IN ANY MANNER TO OTHERS, EXCEPT TO MEET THE SPECIFIC PURPOSE FOR WHICH IT WAS DELIVERED.

**AZTEC TENTS**  
 DESIGN & PRODUCTION  
 2665 COLUMBIA ST. TORRANCE, CA. 90503  
 (800) 228-3687 - FAX (310) 381-0722

JT LITE FRAME TENT  
 15'W x 40'L w/ 10'MIDS  
 PART NUMBER:

REVISION HISTORY			
REV.	DESCRIPTION	BY:	DATE:

**SALES**

ENGINEER: N/A      DATE: 10/10/2016  
 PAGE: 1 OF 1      DRAWN: ELVIS